

AMERICAN PIPE MANUAL

TWENTIETH EDITION

2016

AMERICAN reserves the right to modify or change designs, materials, specifications, or dimensions shown herein without prior notice.

This is the 20th Edition of the AMERICAN Pipe Manual. It is the responsibility of the user to check the Internet for the most current version of this manual. This manual can be found at www.american-usa.com. Printed copies are for reference only and are UNCONTROLLED.





AMERICAN

DUCTILE IRON PIPE

Table of Contents

Introduction

Section 1 AMERICAN Standards

Section 2 Pipe Joints

Section 3 Ductile Iron Pipe

Section 4 Flex-Ring and Lok-Ring Fittings

Section 5 Mechanical Joint Fittings

Section 6 Flanged Fittings

Section 7 Specials

Section 8 Flanged Pipe

Section 9 Restrained Joint Pipe

Section 10 Ball Joint Pipe

Section 11 Linings and Coatings

Section 12 Historical Data

Section 13 Engineering Data

Section 14 General Index

Section 1

AMERICAN Standards





Summary of Standards for Ductile Iron Pipe and Ductile Iron Fittings

Most of the Standards covering pipe and fittings manufactured by American Cast Iron Pipe Company have been prepared by the American Water Works Association Standards Committee A21. Applicable Standards, other than those developed by the A21 Committee, generally cover specialties or refer to ANSI Standards.

In order to take advantage of modern metallurgical science, better testing methods, improved production control, materials with better physical properties, and improvements in manufacturing methods, the A21 Committee has a continuing program for keeping its Standards revised to include the latest proven developments.

Development of Standards

The AWWA Standards Committee A21 on Ductile and Gray Iron Pipe and Fittings was organized in 1926 under the procedures of the American Engineering Standards Committee. It was reorganized under American Standards Association Procedures in 1955, and in 1984 it became a member of the AWWA Committee structure.

The Committee is responsible for the development of standards and manuals for ductile iron pressure pipe for water and other liquids and for fittings used with such pipe. The Committee's membership is comprised of representatives from consumer groups, producer groups and general interest groups.

A standard, manual or revision is developed by a subcommittee assigned to that task. The subcommittee prepares and submits the document to the Standards Committee for approval. After approval it is then submitted to the AWWA Standards Council for approval. After all approvals have been received, including a public review by both AWWA and ANSI, the standard, manual or revision is published and made available to the public.

Specification History

A brief review of the older specifications in chronological order may help define their usefulness, as well as help in the appreciation of the improved modern standards.

Abbreviations of Organizations

The following is a list of the organizations referred to in this Section and other Sections of this Manual by abbreviation.

| | |
|---|--------|
| American Association of State Highway and Transportation Officials..... | AASHTO |
| Alloy Casting Institute..... | ACI |
| American Gas Association..... | AGA |
| American Iron and Steel Institute..... | AISI |
| American National Standards Institute..... | ANSI |
| American Petroleum Institute..... | API |
| American Society of Civil Engineers..... | ASCE |
| American Society of Mechanical Engineers..... | ASME |
| American Society for Testing and Materials..... | ASTM |
| American Water Works Association..... | AWWA |
| Ductile Iron Pipe Research Association..... | DIPRA |
| Ductile Iron Society..... | DIS |
| Factory Mutual System..... | FM |
| International Organization for Standardization..... | ISO |
| United States Military..... | MIL |
| New England Water Works Association..... | NEWWA |
| NSF International..... | NSF |
| Underwriters Laboratories..... | UL |
| Water Environment Federation..... | WEF |



AMERICAN DUCTILE IRON PIPE

The basis for design in almost all specifications to date is the Barlow formula, or “Hoop Stress” formula. It embodies the basic principle for design of a thin cylinder for internal pressure. The formula may be stated as:

$$t = \frac{pd}{2S}$$

in which t is the thickness of the pipe in inches; p is the internal pressure in pounds per square inch (psi); d is the outside diameter in inches; and S is the allowable working stress of the metal in pounds per square inch.

In the development of the design of cast iron pipe, this formula has been modified in several ways by prominent water works engineers such as Allen Hazen, Thomas H. Wiggin, James T. Fanning, Dexter Brackett, I. J. Fairchild and James P. Kirkwood. Mr. Kirkwood, as chief engineer for the Brooklyn Water Works, developed a design for cast iron pipe which was a variant of the Barlow formula. Kirkwood’s calculations took into consideration casting imperfection, corrosion, strength of the metal and other factors affecting the life of the pipe. In the late 1880s, a formula by Dexter Brackett, distribution engineer for the City of Boston, was adopted by the New England Water Works Association as their standard. The formula is as follows:

$$t = \frac{(p + p_1)r}{3,300} + 0.25$$

in which t is the thickness of the pipe wall in inches; p is the static pressure in psi; p_1 is the pressure allowed for water hammer in psi; r is the internal radius of the pipe in inches; 3,300 is equal to one-fifth the tensile strength of cast iron, taken as 16,500 psi; and 0.25 is an allowance for corrosion and foundry tolerance in inches. Brackett accordingly used a safety factor of 5 in his formula.

Although the 1902 NEWWA specifications did not provide a formula for pipe thicknesses, the Brackett formula was used in determining the thicknesses recommended.

The AWWA in 1908 adopted a standard covering bell and spigot pipe produced

in 12-foot laying lengths by the pit casting method. Prior to 1908, at least two unofficial documents dealing with pipe design were acknowledged by AWWA. The first of these used thicknesses for pipe determined by averaging the thicknesses used in a large number of American cities. The second dealt with actual design of pipe based on Brackett’s method with variations.

The 1908 AWWA standards employed a system of class designations applied to specific wall thicknesses in diameters 4” through 84” inclusive for a range of hydraulic heads. The most common of these classes were A, B, C and D for 100-, 200-, 300- and 400-foot hydraulic head, respectively. The design was based on a variation of the Brackett formula by J. T. Fanning and included a variation in the outside diameter for the different classes of pipe. The basic design of pipe with a different outside diameter for each class was followed in modern specifications until the 1961 revisions. The general acceptance by the water works industry of the standardized mechanical joint necessitated a standard outside diameter for cast iron pipe.

AWWA revised their standards in 1939 to incorporate a new method of designing cast iron pressure pipe. This new method was published as ANSI A21.1. The A21.1 method of determining the required thickness of cast iron pipe takes into consideration trench load and internal pressure in combination. Trench load consists of the earth load on the pipe plus any superload resulting from traffic over the trench; internal pressure consists of the design working pressure plus an additional allowance for surge pressure. Laying conditions and strength of the iron in the pipe are also factors involved in the design. Additions for casting tolerance and a corrosion allowance are included in the design thickness.

Actually, the first standard covering centrifugally cast pipe was issued by the United States Government in 1927, and was known as the Federal Specification No. 537. In July 1931, the specification was revised to include pipe cast centrifugally in



sand-lined molds, pipe cast centrifugally in metal molds, and pit cast pipe. This specification has been modified several times and now is basically the same as ANSI/AWWA Standards.

Development of ductile iron in the 1950s initiated research into design of ductile iron pipe to take advantage of the superior strength, toughness, impact resistance and corrosion resistance of this new metal. The A21 Committee issued the ANSI A21.50 (AWWA H3-65) and ANSI A21.51 (AWWA C151) Standards for ductile iron pipe in 1965. The work of Prof. M. G. Spangler and others at Iowa State University on flexible conduit is the basis for principles that have been applied extensively by the designers of flexible underground pipe. The design principles and procedures for ductile iron pipe that were included in the ANSI

Standard A21.50 (AWWA C150) were verified by actual trench tests at AMERICAN and by tests conducted by various researchers.

Continued research on ductile iron pipe reflects through these updated standards the advancements in metallurgical technology and manufacturing skills. Furthermore, the quality of AMERICAN's products and conformance to appropriate specifications are assured by the British Standards Institute's certification that AMERICAN's quality system complies with ISO 9001 Quality Management System Standard.

AMERICAN also subscribes to NSF's listing program for products under ANSI/NSF Standard 61—Drinking Water System Components—Health Effects. Check AMERICAN for current listing of our products.



Tests were conducted at AMERICAN on an installation of five 36" Special Class 51 AMERICAN Ductile Iron Fastite® Joint pipe. Trench is shown with pipe backfilled to spring line and ready for placement of 8' earth cover over the pipe, in a wide trench condition. The ends of the trench were provided with thrust blocking so that the pipeline could be hydrostatically pressurized for testing. Instrumentation consisted of vertical and horizontal deflection gauges, soil pressure gauges, SR-4 electric strain gauges and a hydrostatic pressure gauge. The results of this testing confirmed the applicability of flexible pipe design to ductile iron pipe and became the basis for the first national standard for ductile iron pipe, ANSI A21.50 — 1965 (AWWA H3-65), "American Standard for the Thickness Design of Ductile Iron Pipe." Inset — Vertical deflection gauge which measured vertical deflection of the pipe, as well as the amount of embedment of the pipe into the trench bottom.



Standards Applicable to AMERICAN Pipe and Fittings

Throughout this Manual, Standards may be referred to as listed below or by only the ANSI, AWWA, ASTM, NSF, ASME, etc. numbering.

| | |
|--|---|
| Ductile Iron Pipe for Water and Other Liquids: 4" through 64" | ANSI/AWWA C150/A21.50 ANSI/AWWA C151/A21.51 |
| Ductile Iron Gravity Sewer Pipe: 4" through 64" | ASTM A746 |
| Ductile Iron Culvert Pipe: 14" through 64" | ASTM A716 |
| Ductile and Gray Iron Fittings for Water and Other Liquids: 4" through 48" | ANSI/AWWA C110/A21.10 |
| Ductile Iron Compact Fittings: 4" through 64" | ANSI/AWWA C153/A21.53 |
| Flanged Pipe: 4" through 64" | ANSI/AWWA C115/A21.15 |
| Coatings and Linings: Asphaltic | ANSI/AWWA C110/A21.10 ANSI/AWWA C115/A21.15 ANSI/AWWA C151/A21.51 ANSI/AWWA C153/A21.53 ASTM A716 |
| Cement Lining | ANSI/AWWA C104/A21.4 ASTM A746 |
| Ceramic Epoxy | PROTECTO 401 ASTM A746 |
| Coal Tar Epoxy Lining | PROTECTO 401 |
| Polyethylene Encasement | ANSI/AWWA C105/A21.5 ASTM A674 |
| Joints — Pipe and Fittings: Fastite® | ANSI/AWWA C111/A21.11 |
| Mechanical | ANSI/AWWA C111/A21.11 |
| Flanged | ANSI/AWWA C110/A21.10 ANSI/AWWA C115/A21.15 ANSI/AWWA C153/A21.53 |
| Grooved and Shouldered | AWWA C606 |
| Other joints shown in this Manual are AMERICAN design. | |
| All Products* | ANSI/NSF Standard 61 |

*Check AMERICAN for current NSF listing of AMERICAN products.

NOTE: Many AMERICAN joints, classes of pipe, fittings, and specials are listed by Underwriters Laboratories Inc. and Factory Mutual System. The quality of AMERICAN's products and conformance to appropriate specifications are assured by the British Standards Institute's certification that AMERICAN's quality system complies with ISO 9001 Quality Management System Standard.



Standards for the Design, Manufacture, Installation and Certification of Ductile Iron Pipe and Ductile Iron Fittings

| Standard Designation | Subject |
|-----------------------------|---|
| ANSI/AWWA C104/A21.4 | Cement-Mortar Lining for Ductile-Iron Pipe and Fittings for Water |
| ANSI/AWWA C105/A21.5 | Polyethylene Encasement for Ductile-Iron Pipe Systems |
| ANSI/AWWA C110/A21.10 | Ductile-Iron and Gray-Iron Fittings, 3 in. through 48 in., for Water |
| ANSI/AWWA C111/A21.11 | Rubber-Gasket Joints for Ductile-Iron Pressure Pipe and Fittings |
| ANSI/AWWA C115/A21.15 | Flanged Ductile-Iron Pipe with Ductile-Iron or Gray-Iron Threaded Flanges |
| ANSI/AWWA C150/A21.50 | Thickness Design of Ductile-Iron Pipe |
| ANSI/AWWA C151/A21.51 | Ductile-Iron Pipe, Centrifugally Cast for Water |
| ANSI/AWWA C153/A21.53 | Ductile-Iron Compact Fittings, for Water Service |
| ANSI/AWWA C600 | Installation of Ductile-Iron Water Mains and Their Appurtenances |
| ANSI/AWWA C606 | Grooved and Shouldered Joints |
| ASTM A674 | Polyethylene Encasement for Ductile Iron Pipe for Water or Other Liquids |
| ASTM A716 | Ductile Iron Culvert Pipe |
| ASTM A746 | Ductile Iron Gravity Sewer Pipe |
| ANSI/NSF 61 | Drinking Water System Components—Health Effects |
| ASTM G62 | Standard Test Methods for Holiday Detection in Pipeline Coatings |



Miscellaneous Standards

The following Standards are related to ductile iron and gray iron piping but are generally not directly applicable to the manufacture of AMERICAN pipe and fittings.

| Standard Designation | Subject |
|-----------------------------|---|
| ANSI A40.5 | Threaded Cast-Iron Pipe for Drainage, Vent, and Waste Services |
| ANSI/ASME B1.1 | Unified Inch Screw Threads (UN and UNR Thread Form) |
| ANSI/ASME B16.1 | Cast Iron Pipe Flanges and Flanged Fittings, Class 25, 125, 250 and 800 |
| ANSI/ASME B16.3 | Malleable-Iron Threaded Fittings, 150 and 300 lb |
| ANSI/ASME B16.4 | Cast-Iron Screwed Fittings, 125 and 250 lb |
| ANSI/ASME B16.5 | Pipe Flanges and Flanged Fittings |
| ANSI B16.12 | Cast Iron Threaded Drainage Fittings |
| ANSI B16.14 | Ferrous Pipe Plugs, Bushings, and Lock-nuts with Pipe Threads |
| ANSI B16.21 | Nonmetallic Flat Gaskets for Pipe Flanges |
| ASME/ANSI B16.42 | Ductile Iron Pipe Flanges and Flanged Fittings |
| ANSI B18.2.1 | Square and Hex Bolts and Screws, Inch Series |
| ANSI/ASME B18.2.2 | Square and Hex Nuts (Inch Series) |
| ANSI B31.1 | Power Piping |
| ANSI/ASME B31.8 | Gas Transmission and Distribution Piping Systems |
| ANSI/ASME B1.20.1 | General Purpose Pipe Threads |
| ANSI/AWWA C207 | Steel Pipe Flanges for Waterworks Service - Sizes 4 in. through 144 in. |
| ANSI/AWWA C500 | Gate Valves - 3 in. through 48 in. NPS, For Water and Sewage Systems |
| ANSI/AWWA C501 | Sluice Gates |
| ANSI/AWWA C502 | Dry-Barrel Fire Hydrants |
| ANSI/AWWA C503 | Wet-Barrel Fire Hydrants |
| ANSI/AWWA C504 | Rubber-Seated Butterfly Valves |
| ANSI/AWWA C508 | Swing-Check Valves for Ordinary Waterworks Service |
| ANSI/AWWA C509 | Resilient-Seated Gate Valves for Water and Sewage Systems |
| ANSI/AWWA C550 | Protective Interior Coatings for Valves and Hydrants |
| ASTM A48 | Gray Iron Castings |
| ASTM A74 | Cast Iron Soil Pipe and Fittings |



| Standard Designation | Subject |
|-----------------------------|---|
| ASTM A126 | Gray Iron Castings for Valves, Flanges, and Pipe Fittings |
| ASTM A278 | Gray Iron Castings for Pressure-Containing Parts for Temperatures Up to 650°F (345°C) |
| ASTM A319 | Gray Iron Castings for Elevated Temperatures for Non-Pressure Containing Parts |
| ASTM A377 | Standard Index of Specifications for Ductile Iron Pressure Pipe |
| ASTM A395 | Ferritic Ductile Iron Pressure Retaining Castings for Use at Elevated Temperatures |
| ASTM A438 | Transverse Testing of Gray Cast Iron |
| ASTM A476 | Ductile Iron Castings for Paper Mill Dryer Rolls |
| ASTM A518 | Corrosion-Resistant High-Silicon Iron Castings |
| ASTM A536 | Ductile Iron Castings |
| ASTM A571 | Austenitic Ductile Iron Castings for Pressure Containing Parts Suitable for Low-Temperature Service |
| ASTM C150 | Portland Cement |
| ASTM D1248 | Polyethylene Plastic Molding and Extrusion Materials |
| ASTM E8 | Tension Testing of Metallic Materials |
| AASHTO M64 | Cast Iron Culvert Pipe |
| AASHTO M105 | Gray Iron Castings |
| AWWA D100 | AWWA Standard for Welded Steel Tanks for Water Storage |



AMERICAN

DUCTILE IRON PIPE

THE RIGHT WAY

Section 2

AMERICAN Pipe Joints





AMERICAN Joints for Pipe and Fittings

AMERICAN Fastite® Joint, 4"-64"



The AMERICAN Fastite Joint, furnished in sizes 4"-64", is a flexible, rubber ring compression-type joint used extensively in underground service. See pages 2-6 through 2-15 and Sections 3, 4, 7 and 9.

AMERICAN Fastite® Joint with Fast-Grip® Gasket, 4"-30"



The AMERICAN Fast-Grip Gasket furnished in sizes 4"-30" provides flexible, field-adaptable joint restraint in a standard AMERICAN Fastite (or Flex-Ring) Bell. See Sections 4 and 9.

AMERICAN Flex-Ring® Joint, 4"-12"



The AMERICAN Flex-Ring Joint provides flexible joint restraint against thrust due to internal water working pressure or external forces. It is also used in horizontal directional drilling (HDD) and pipe bursting applications. See Sections 4 and 9.



AMERICAN Joints for Pipe and Fittings

AMERICAN Flex-Ring® Joint, 14"-48"



The AMERICAN Flex-Ring Joint provides flexible joint restraint against thrust due to internal water working pressure or external forces. It is also used in horizontal directional drilling (HDD) and pipe bursting applications. See Sections 4 and 9.

AMERICAN Field Flex-Ring®, 14"-36"

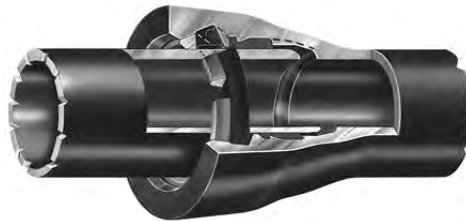

The AMERICAN Field Flex-Ring provides dependable and flexible field-adaptable restraint against thrust due to external forces or internal water working pressure in the standard Flex-Ring joint. This joining structure is also recommended at locations where field cutting is required in 14"-36" Flex-Ring piping. See Sections 4 and 9.

AMERICAN Lok-Ring® Joint, 54"-64"

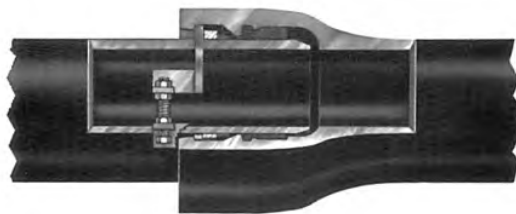

The AMERICAN Lok-Ring Joint is furnished in sizes 54"-64" and provides flexible joint restraint against thrust due to internal water working pressure. See Sections 4 and 9.



AMERICAN Joints for Pipe and Fittings

AMERICAN Mechanical Joint, 4"-48"



The AMERICAN Mechanical Joint, furnished in pipe sizes 4" -12" and in fittings sizes 4" -48", is a flexible stuffing box type connection used primarily in underground service.

See pages 2-16 through 2-21 and Sections 3, 5, 7 and 9.

AMERICAN MJ Coupled Joint, 4"-48"

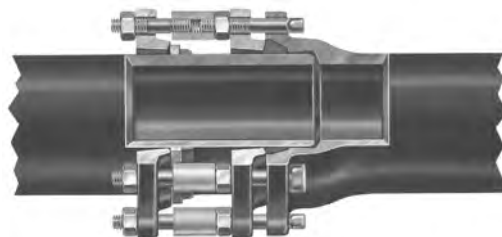

The AMERICAN MJ Coupled Joint is furnished in sizes 4" -48" and is an adaptation of the standard Mechanical Joint to provide joint restraint against thrust due to internal pressure.

See Section 9.

AMERICAN Flanged Joint, 4"-64"



The AMERICAN Flanged Joint, furnished in sizes 4" -64", is widely used for exposed plant piping. In combination with other joints and with AMERICAN's recommended NSF 61 certified Toruseal® gasket, it is also commonly used for Long Span installations.

See Sections 6, 7 and 8.



AMERICAN Joints for Pipe and Fittings

AMERICAN Flex-Lok® Joint, 4"-24"

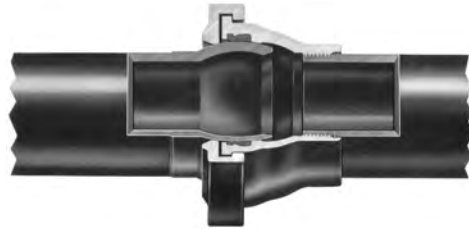

The AMERICAN Flex-Lok Joint, furnished in sizes 4"-24", is a boltless, very flexible joint. This joint is designed to provide up to 15° joint deflection for subaqueous or other difficult installations.
See Section 10.

AMERICAN Flex-Lok® Joint, 30"-60"



The AMERICAN Flex-Lok Joint, furnished in sizes 30"-60", is a boltless, very flexible joint. This joint is designed to provide up to 15° joint deflection for subaqueous or other difficult installations. Contact AMERICAN for 64" size requirements.
See Section 10.



AMERICAN Joints for Pipe and Fittings

AMERICAN Grooved and Shouldered Joint, 4"-64"

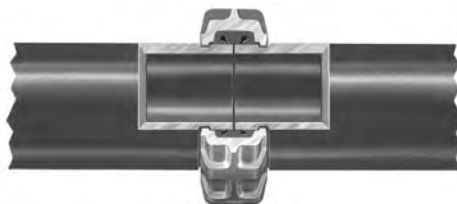

The AMERICAN Grooved Joint pictured above—and to a limited extent the Shouldered Joint (not pictured)—are furnished for some plant piping installations. See Section 2.

AMERICAN Fastite® Joint Push-Bar™ Pipe, 4"-64"

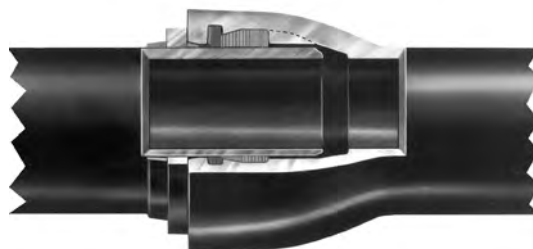

AMERICAN Fastite Joint Push-Bar pipe, furnished in sizes 4"-64", allows the AMERICAN Fastite Joint to be used in trenchless installations using direct jacking or pushing (including high load installations such as microtunneling and some pipe bursting applications). See Section 7.



AMERICAN Fastite® Joint Pipe For Water, Sewage or Other Liquids

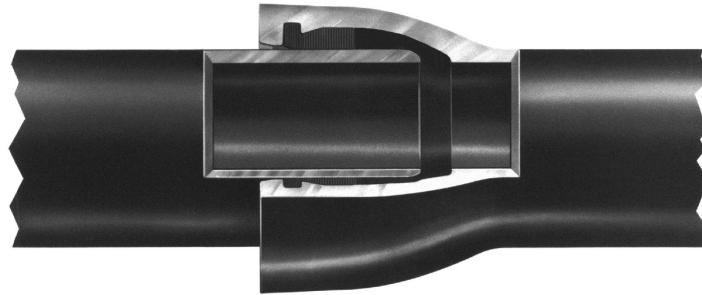

AMERICAN Fastite Joint Pipe in sizes 4" -64" for water, sewage or other liquids has the proven long-life and high-strength qualities inherent in pipe produced centrifugally in accordance with AWWA C151. In addition, this significant AMERICAN development, a dependable, single gasket, push-on type joint meeting the requirements of AWWA C111, affords the customer lower joint cost and time-saving advantages in installation. It provides exceptional strength and flexibility and has been widely accepted by engineers, contractors and utility officials since the 1950s. For added flexibility during construction, and for possible elimination of bends, a liberal 5° allowable deflection is standard in all sizes through 30", offering 21" offset in a 20' length of pipe. Liberal deflection can also be provided in larger diameter pipe with standard and Special Fastite Deflection Bells.

The patented AMERICAN Fastite Joint embodies many advanced design features and is rated for a water working pressure of 350 psi. For specific conditions, ductile iron piping with this joint has been approved for much higher pressure conditions. The socket, which is scientifically designed with two gasket recesses and a dividing buttress, is manufactured to close tolerances so that the gasket is self-centered, securely confined, and firmly compressed for a permanent, tight, trouble-free joint. The Fastite joint seal, bubble-tight under vacuum and external pressure, becomes even tighter with the application of internal pressure due to a specially designed wedging surface in the socket.

Fastite Joint Assembly

The bell opening is slightly tapered to provide easy entry of the pipe end; the flared socket design permits liberal joint deflection. The

plain end of the pipe is tapered or rounded to facilitate entry into the bell and self-centering in the gasket. On pipe cut in the field, the plain end can be easily beveled and smoothed by the use of a portable grinding wheel or other suitable apparatus. Methods of cutting ductile iron pipe are described in Section 3.

A stripe is painted on the plain end of AMERICAN Fastite Joint Pipe to provide a visual means of checking the joint alignment and to assure proper insertion. See page 2-10 for detailed assembly instructions.

Fastite Gasket

The Fastite Joint sealing component—a molded synthetic rubber ring gasket of two hardnesses, shaped to fit the configuration of the gasket socket—is manufactured per all requirements of ANSI/AWWA C111/A21.11 and under AMERICAN's own rigid specifications, assuring closely controlled dimensional and hardness properties. The smaller end of the gasket is of harder rubber, approximately 85 durometer hardness, which provides a strong shoulder for self-centering on the gasket buttress, a permanent seal against cold flow, and protection from deterioration. The larger end of the gasket is of softer rubber, approximately 65 durometer hardness, providing ease of assembly and positive sealing. The design assures effective sealing at low or high pressures and in straight or deflected joint alignment. It also eliminates any concerns of infiltration or root intrusion, and assures positive sealing against negative pressure, thus preventing gasket "pullout" should a vacuum be created in the line.

A taper on the inside of the gasket allows the entering pipe to locate and center on the hard section and along with a coated and



subsequent assembly. The snug fit and the hard section of the gasket, in conjunction with the design of the buttress, act to restrain the gasket against dislodgment during assembly. Additional internal pressure results in increased tightness of the seal when pipe is either in straight alignment or deflected.

Gaskets made of SBR (Styrene Butadiene Rubber) are standard. For information on gaskets made of special types of rubber, for applications involving air or liquid temperatures in excess of 150°F, or for chemical, hydrocarbon or other special service applications, and for installations in contaminated soils where permeation through gaskets might be a concern, consult AMERICAN for recommendations. See Table 2-1.

Fastite Lubricant

AMERICAN Fastite Joint Lubricant is a non-toxic water soluble material imparting neither taste nor odor to the conveyed water and is ANSI/NSF 61 approved. The lubricant is suitable

for use in hot or cold weather and will adhere to wet or dry pipe. AMERICAN Fastite Joint Pipe can be assembled when submerged, though for such installation, special AMERICAN underwater joint lubricant is recommended. See Table No. 2-5 for appropriate lubricant quantities.

Fastite Joint Materials

Standard joint materials include Fastite plain rubber gaskets and a sufficient supply of Fastite joint lubricant. Fastite pipes are most often readily joined with available excavating equipment; however, assembly tools can be supplied by AMERICAN on a loan basis with a nominal deposit which is refundable upon return of tools in good condition.

Coating and Lining

AMERICAN Fastite Joint Pipe can be furnished asphaltic coated, cement lined, or with special coating or lining where required. See Section 11.

Fastite Gaskets

Table No. 2-1

| Common Name or Trade Name* | Chemical Name | Maximum Service Temperature** | | Common Uses |
|-----------------------------------|----------------------------------|-------------------------------|-------|---|
| | | Water & Sewer | Air | |
| Plain Rubber | Styrene Butadiene Copolymer(SBR) | 150°F | 150°F | Fresh Water, Salt Water, Sanitary Sewage |
| Plain Rubber (conductive) | Styrene Butadiene Copolymer(SBR) | 150°F | 150°F | Electrical continuity for thawing of Service Water and Sewage |
| EPDM | Ethylene Propylene Diene Monomer | 212°F | 200°F | Water, Sewage, Ketones, Dilute Acids and Alkalies, Vegetable Oil, Alcohols, Air |
| Neoprene | Polychloroprene(CR) | 200°F | 180°F | Fresh Water, Sewage |
| Nitrile Buna-N | Acrylonitrile Butadiene(NBR) | 150°F | 150°F | Non-Aromatic Hydrocarbons, Petroleum Oil, Hydraulic Fluids, Fuel Oil, Fats, Oil, Grease† |
| Fluoroelastomer Fluorel Viton®*** | FKM | 212°F | 300°F | Aromatic Hydrocarbons, Gasoline, Refined Petroleum Products, most Chemicals and Solvents, High Temp., Air (Least permeable of all available Fastite gasket rubbers) |

Gaskets used with AMERICAN joints and not manufactured by an authorized AMERICAN gasket manufacturer invalidate any warranties for joints and gaskets.

*AMERICAN reserves the right to furnish any Trade or Brand rubber for the chemical formulation specified.

Temperature is in reference to conveyed fluid. **Lubricating oil in air can adversely affect SBR and EPDM performance. SBR, Nitrile and Neoprene are not recommended for hot air exposure in wastewater treatment systems.

***Viton® is a registered trademark of DuPont Dow Elastomers.

Refer to Section 11 for temperature and service capabilities of pipe linings.

Refer higher temperatures or other special requirements to AMERICAN for recommendations regarding suitable gasket material.

†This gasket rubber is chemically resistant in the non-potable water uses shown but is not as resistant to permeation in potable water applications as FKM.

All Fastite gaskets made from the materials in the above table are suitable for use with water containing normal concentrations of chloramine. Where increased resistance to chloramine is desired, neoprene or fluoroelastomer materials should be considered.



**AMERICAN Fastite® Joint
for Ductile Iron Pipe
ANSI/AWWA C111/A21.11
Standard Dimensions**

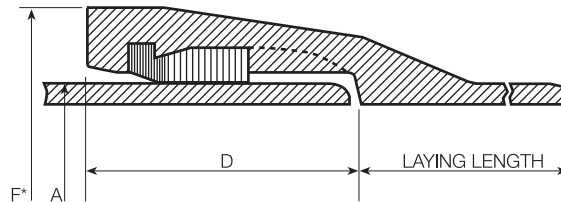

Table No. 2-2

| Size in. | Nominal Laying Length ft. | Dimensions in Inches | | |
|-------------|---------------------------------|-----------------------|----------------------|-----------------|
| | | A Outside Diameter | D Depth of Socket | F* Bell O.D. |
| 4 | 20 | 4.80 | 3.31 | 6.40 |
| 6 | 20 | 6.90 | 3.38 | 8.60 |
| 8 | 20 | 9.05 | 3.75 | 10.96 |
| 10 | 20 | 11.10 | 3.75 | 13.12 |
| 12 | 20 | 13.20 | 3.75 | 15.22 |
| 14 | 20 | 15.30 | 5.23 | 17.61 |
| 16 | 20 | 17.40 | 5.23 | 19.74 |
| 18 | 20 | 19.50 | 5.50 | 22.16 |
| 20 | 20 | 21.60 | 5.50 | 24.28 |
| 24 | 20 | 25.80 | 5.50 | 28.50 |
| 30 | 20 | 32.00 | 6.50 | 34.95 |
| 36 | 20 | 38.30 | 6.50 | 41.37 |
| 42 | 20 | 44.50 | 7.50 | 48.27 |
| 48 | 20 | 50.80 | 8.00 | 54.71 |
| 54 | 20 | 57.56 | 8.50 | 61.65 |
| 60 | 20 | 61.61 | 8.75 | 65.80 |
| 64 | 20 | 65.67 | 9.00 | 70.04 |

*Dimensions subject to change at our option. Check AMERICAN if exact dimensions required.
See Section 3 for additional information on ductile iron pipe.
See Sections 4 and 7 for information on Fastite fittings.



AMERICAN Fastite® Joint Pipe
Allowable Joint Deflection

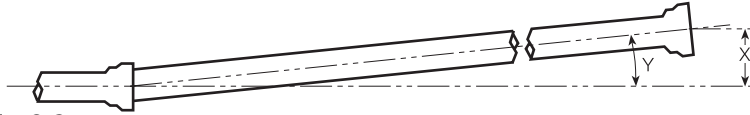

Table No. 2-3

| Size in. | Nominal Laying Length ft. | Maximum Recommended Deflection† | | | | | |
|----------|---------------------------|---------------------------------|--------------------|----------------------|---------------------------------|--------------------|----------------------|
| | | Standard Bell | | | Special Deflection Bell | | |
| | | X Offset per Nominal Length in. | Y Deflection Angle | Radius of Curve* ft. | X Offset per Nominal Length in. | Y Deflection Angle | Radius of Curve* ft. |
| 4 | 20 | 21 | 5° | 230 | — | — | — |
| 6 | 20 | 21 | 5° | 230 | — | — | — |
| 8 | 20 | 21 | 5° | 230 | — | — | — |
| 10 | 20 | 21 | 5° | 230 | — | — | — |
| 12 | 20 | 21 | 5° | 230 | — | — | — |
| 14 | 20 | 21 | 5° | 230 | — | — | — |
| 16 | 20 | 21 | 5° | 230 | — | — | — |
| 18 | 20 | 21 | 5° | 230 | — | — | — |
| 20 | 20 | 21 | 5° | 230 | — | — | — |
| 24 | 20 | 21 | 5° | 230 | — | — | — |
| 30 | 20 | 21 | 5° | 230 | — | — | — |
| 36 | 20 | 17 | 4° | 285 | 21 | 5° | 230 |
| 42 | 20 | 12 | 3° | 380 | 21 | 5° | 230 |
| 48 | 20 | 12 | 3° | 380 | 17 | 4° | 285 |
| 54 | 20 | 12 | 3° | 380 | 17 | 4° | 285 |
| 60 | 20 | 12 | 3° | 380 | 17 | 4° | 285 |
| 64 | 20 | 12 | 3° | 380 | 17 | 4° | 285 |

*Approximate radius of curve produced by a succession of nominal lengths of pipe fully deflected.

†Special Deflection Bells must be specifically ordered and will be marked with white bell face for easy identification.

For easiest assembly, the joints should be assembled with the pipe in reasonably straight alignment. After joint assembly, the pipe may be deflected up to the maximum shown above. Offset distances are based on 20-ft lengths.

Maximum Allowable Separation

Table No. 2-4

| Size in. | S Separation in. |
|----------|------------------|
| 4 | 3/8 |
| 6 | 9/16 |
| 8 | 3/4 |
| 10 | 15/16 |
| 12 | 1 1/8 |
| 14 | 1 5/16 |
| 16 | 1 1/2 |
| 18 | 1 5/8 |
| 20 | 1 7/8 |
| 24 | 2 1/4 |
| 30 | 2 3/4 |
| 36 | 2 5/8 |
| 42 | 2 1/4 |
| 48 | 2 1/2 |
| 54 | 2 7/8 |
| 60 | 3 1/8 |
| 64 | 3 3/8 |

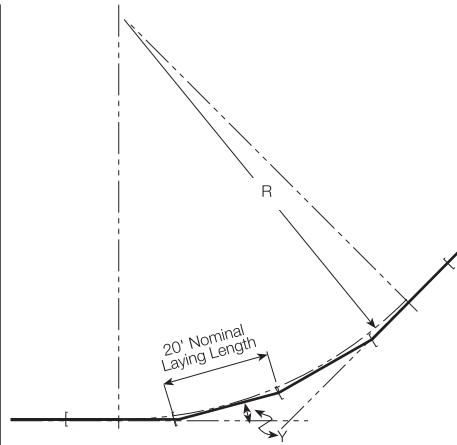
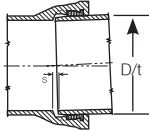

R = Radius of Curve (ft.)

Y = Deflection Angle (degrees)

$$\text{Radius of Curve} = \frac{\text{Nominal Laying Length}}{2 \times \text{Tangent}(Y \div 2)}$$

Maximum Allowable Separation, "S", in Standard Bell pipe is approximately equal to the median pipe diameter in inches times the sine of the deflection angle. This is provided for information only and should not be used to determine precise joint deflection.



AMERICAN Fastite® Joint Pipe Assembly Instructions

The AMERICAN Fastite Joint is a push-on type joint meeting all the rigorous requirements of AWWA C111. The ANSI/AWWA C600 Standard covers in detail the installation of ductile iron water mains, including assembly instructions for push-on joint pipe.

Field-cutting of AMERICAN Ductile Iron Pipe can be easily performed, thus eliminating the necessity for factory-made special lengths of Fastite pipe. The plain end of Fastite pipe cut in the field requires little or no preparation for assembly into the socket of a mechanical joint fitting. Where a cut pipe is to be assembled into a Fastite socket, the required beveling or rounding of the plain end can be easily accomplished by the use of a portable grinding wheel or other suitable apparatus. Methods of cutting ductile iron pipe are described in Section 3.

The AMERICAN Fastite Joint requires only one joint component, the rubber gasket*, which when properly installed, fits snugly in the gasket recess in the bell socket. A special lubricant supplied with the pipe is applied to the plain end and the inside surface of the gasket before assembly. The pipe end is tapered or rounded to provide self-centering of the plain end in the gasket and ease of assembly. A circumferential stripe on the plain end provides a visual indication for checking the proper insertion of the joint. The stripe, shown in the photographs illustrating assembly methods, passes fully into the bell when the plain end is fully inserted into the socket with the two lengths of pipe in straight align-

ment. Joints can then be safely deflected up to the extent shown in Table No. 2-3. In deflected joints, the stripe will typically be visible to some extent after assembly.

Easier assembly is effected if the pipe is suspended an inch or so off the bottom of the trench during the jointing operation.

The following instructions should be followed in order to properly assemble the joints and to fully realize the maximum speed and ease of assembly of the Fastite Joint:

1. Clean socket and plain end thoroughly, **removing mud, gravel, or any other matter that might cause the front of the gasket to protrude into the path of the entering spigot.**

2. Insert gasket fully into the gasket recess of the socket, large end of the gasket entering first. Gasket may be installed with one or two V-shaped folds as shown (Photo 1). After the gasket is in place at the bottom, the top of the gasket is positioned fully into the gasket recess. Gaskets and lubricant to be installed in very cold weather should be warmed first (as by storage in a heated equipment cab or pick-up, etc.) for optimum assembly.

3. Apply a thin film of regular AMERICAN Fastite Joint Lubricant to the rounded or tapered spigot end of the pipe, the immediate outside pipe surface between the stripe and the nose of the pipe (Photo 2), and also to the inside surface of the gasket. **Special AMERICAN Fastite Joint Lubricant intended specifically for underwater or very wet installations can be supplied when requested.**



Photo 1



Photo 2

*Gaskets not used immediately should be stored in a cool location, out of direct sunlight.



Caution: If a spigot end contacts the ground or trench side after lubrication, any adhering dirt or rocks should be cleaned off and the area re-lubricated prior to assembly.

4. Insert the plain end in the socket. For optimum assembly it is preferable that the entering pipe be in reasonably straight alignment; however, the Fastite Joint may be assembled if necessary with the pipe deflected within its rated deflection. (Exception: If Fast-Grip gaskets are being used, straight alignment must be maintained.) Push the plain end into the socket using any of the applicable assembly methods described hereinafter. If the joint cannot be assembled with a moderate force, remove the pipe and check for the cause of the difficulty, such as improper positioning of gasket, insufficient or wrong type lubricant, dirt under or behind the gasket, dirt adhering to the pipe, or any other cause which would result in obstruction or increased friction between pipe end and

gasket surface. **For assurance of proper assembly, a thin automotive, blade-type feeler gauge can also be used if desired for quick and easy probe confirmation of correctly installed axial gasket position around the joint.**

5. "Backwards" installation. AMERICAN does not recommend "backward laying" (bells assembled over spigots, rather than spigots inserted into bells as pictured in this literature) of large-diameter ductile iron pipe in buried installations. AMERICAN can furnish bell and plain end fittings to minimize the need for backward pipe laying. Other devices such as sleeves and couplings may also be employed for this reason. However, if this condition cannot be avoided, we strongly recommend that installers contact AMERICAN for instructions on how to reduce the potential for problems that could occur when assembling pipe in this manner.

AMERICAN Pipe Assembly Mechanisms

In general, Fastite joints or other Fastite gasketed pipes may be readily pushed or pulled together without the need for complicated tools or substantial manpower. This is most often accomplished with the procedures discussed on page 2-14. In general, the joints of AMERICAN push-on pipes are purposefully "tight," and most joints require an assembly force of about 100 to 200 pounds or more of assembly force per inch of pipe diameter (i.e. a 12" joint might require about 12 x 100 or 1,200 pounds of assembly force).

In pulling operations, simply wrap a sound wire rope choker cable or nylon sling around the barrel of the entering pipe. Secure the thimble eye or other end loop of the choker to a suitably anchored pulling device (e.g. backhoe, come-along, etc.). Use the mechanism to pull the cable taut in the

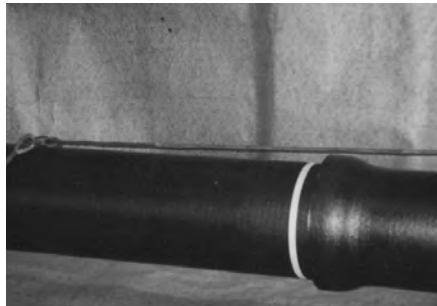

Photo 3

assembly direction (Photo 3). Continue pulling the cable in a smooth, continuous motion until the joint is in the fully assembled position. If desired for special conditions, AMERICAN can furnish suitable, simple come-alongs and choker cables for manpower assembly of

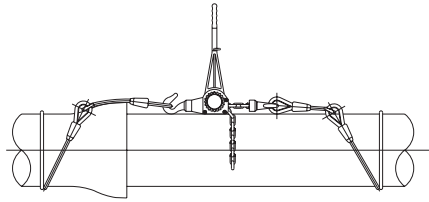

Figure 1
most 4"-24" pipes (See Figure 1 and specify pipe sizes involved).

The joints may normally be disassembled in a similar manner, reversing the direction of the pull with the choker cable (Photo 4). It is also sometimes helpful to use rebating or wiggling deflection to aid in the disassembly of push-on joint pipes, particularly when pipes have been installed for some time prior to removal.

30"-64" Pipe



Photo 4

Large pipes are most often readily pushed or pulled together with heavy excavating/earthmoving equipment available on-site (see page 2-14). In cases where assembly of pipes by manpower is desired, AMERICAN can provide special assembly tools and rigging which can be used for assembling most pipes of all sizes (Photo 5). These tools consist of a heavy-duty roller chain hoist, a steel pipe-end hook and snatch block, and associated wire



Photo 5

rope and chain tackle (Photo 5) to attach all the rigging together to effect "double line" assembly from the top of the pipe (Photo 6). The snatch block pulley and twin line rigging approximately doubles the assembly force from the strong come-along, making possible the assembly of up to 64" full-length pipe joints from the top of the pipe (Photo 7).



Photo 6

Fittings and Short Pipes



Photo 7

Push-on fitting or short pipe joint assembly is basically the same as that of standard length pipe, though special rigging may be necessary to hold these short items reasonably stable for assembly. See also Push-On Fittings Assembly Instructions in Section 4.

Field Rounding

Occasionally, field rounding of pipe ends may be necessary to accomplish assembly, particularly when large-diameter pipes are cut to be assembled into mechanical joints or couplings. Need for rounding in assembly of mechanical or stuffing-box-type joints can be predetermined by a difficulty in sliding the gland or end ring over the end of the pipe. Rounding may be accomplished in the following manner using a mechanical jack and shaped blocks. (Note: This procedure may also be used with the assemblies involving push-on joint pipe, fittings, valves, etc.; however, rounding is less frequently necessary for assembly of push-on joints.)



1. Measure/determine the minimum (minor) diameter of the ends to be rounded.
2. Place the jack and the shaped blocks in line with the minor diameter as shown in the attached sketch using a sound 4"x4" spacer timber cut square to the required length to take up the space.
3. Apply a load carefully with the jack only until the "minimum diameter equals the maximum diameter," or until the gland will easily slip over the end. No more jacking should be attempted or necessary - **DO NOT ATTEMPT TO PERMANENTLY ROUND END.**
4. When no mechanical joint restraint device is used, carefully relax and remove the jack and timbers from the pipe after joint assembly.
5. When using a mechanical joint restraint device not manufactured by AMERICAN, contact the applicable manufacturer of the restraint device regarding installation guidelines.

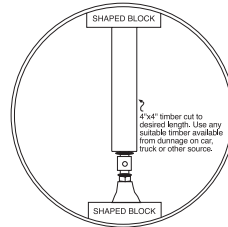

Note: Field rounding operations should be conducted without backfill on any part of large-diameter pipes and prior to encasing any part of pipe in concrete. If the inside of the pipe cannot be accessed to remove jacking materials, pipe ends can alternatively be rounded using external clamping means.

AMERICAN Fastite® Joint Lubricant Requirement by Size of Pipe



64" AMERICAN Fastite Joint pipe being installed in a wastewater application.

Table No. 2-5

| Pipe Size in. | Approx. Pounds of Lubricant per Joint | Approx. No. of Joints per Pound of Lubricant |
|---------------|---------------------------------------|--|
| 4 | .03 | 33 |
| 6 | .045 | 22 |
| 8 | .06 | 17 |
| 10 | .07 | 14 |
| 12 | .08 | 12 |
| 14 | .09 | 11 |
| 16 | .11 | 9 |
| 18 | .12 | 8 |
| 20 | .14 | 7 |
| 24 | .17 | 6 |
| 30 | .30 | 3 |
| 36 | .36 | 3 |
| 42 | .44 | 2 |
| 48 | .50 | 2 |
| 54 | .59 | 2 |
| 60 | .66 | 1 |
| 64 | .71 | 1 |



AMERICAN Fastite® Joint Common Assembly Methods

In seeking ways to take even greater advantage of the cost-reducing features of the Fastite Joint, utility contractors have developed other methods of assembling this joint without special tools. The following methods are described for the information of the user, who may elect to use them at his discretion, keeping in mind that these methods may not be effective for all installations and under all field conditions.

Spade or Crowbar Method

This is applicable to the smaller sizes of AMERICAN Fastite Joint Pipe, and consists of centering the lubricated end of the entering pipe in the gasket and then pushing against the bell face of the entering pipe with a spade or crowbar driven into the ground in front of the bell face. This method requires the trench bottom to be fairly firm soil. The method may not be effective in a rocky trench or with a trench that is soft, muddy or sandy. A wooden block between the bell face and the pry bar may increase the leverage. Easier assembly is effected if the pipe is suspended an inch or so off the bottom of the trench.

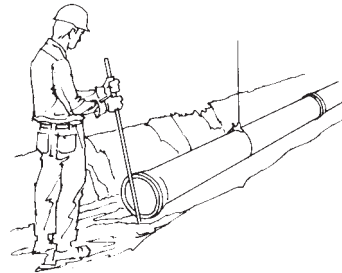

Spade or Crowbar Method

Backhoe and Heavy Equipment Methods

These methods are usually applicable to the intermediate and larger sizes of AMERICAN Fastite Joint Pipe where the bar method might not be effective. It consists of centering the end of the entering pipe in the gasket as the pipe to be assembled is suspended from the backhoe. Then it can be pulled into the adjoining socket with the pipe sling by moving the backhoe arm toward the previously assembled pipe. In other instances, the pipe may be assembled by placing the backhoe or other earth mover bucket or blade against the bell face of the entering pipe and pushing it into the socket. When pushing against the bell face, care should be taken to avoid very small contact areas and possible damage to the pipe bells or spigots. Wood cushions between the backhoe bucket and the pipe are particularly effective in preventing damage.

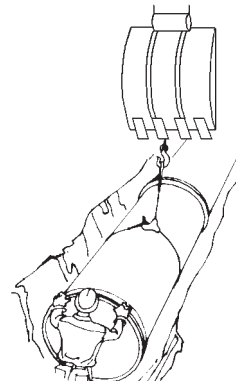

Backhoe and Heavy Equipment Methods



AMERICAN Fastite® Conductive Joints Fastite Conductive Gaskets

For cold climates where electrical thawing of service connections is required, metal contact strips are molded into the Fastite gasket, providing a “built-in” contact which will carry the necessary current between the socket and the pipe end. Under compression, the rubber gasket forces the contact strips firmly against the metal surfaces. This design assures an enclosed and protected contact which remains effective against expansion, contraction or future movement of the joint. Special preparation of the pipe sockets and plain ends is required when using conductive gaskets. Instructions are outlined on each can of AMERICAN Fastite Joint Lubricant. The Fastite Joint Conductive Gasket is satisfactory for transmission of electrical current up to 600 amps.

Other types of joint bonding are used to provide electrical conductivity across joints for low voltage/current requirements, such as for corrosion monitoring or cathodic protection.

In assembling Fastite pipe with conductive gaskets, both plain end and socket must be thoroughly cleaned and be free of rust and from asphaltic or other coating material. A protective coating is applied to the sockets and beveled ends of Fastite Conductive Joint pipe prior to shipment to prevent oxidation on the gasket seating surfaces during transportation and storage prior to assembly. Thorough cleaning of the gasket seating surfaces in the socket and on the plain end is required prior to assembly to provide proper electrical contact between the copper clips and the metallic surfaces of the joint.

Assembly from this point is the same as described previously for the Fastite Joint.

Note: Fastite Conductive Gaskets should not be used with Fastite restrained plugs. Some sizes of Fastite pipes may not be suitable for use with Conductive Gaskets – contact AMERICAN to check availability.

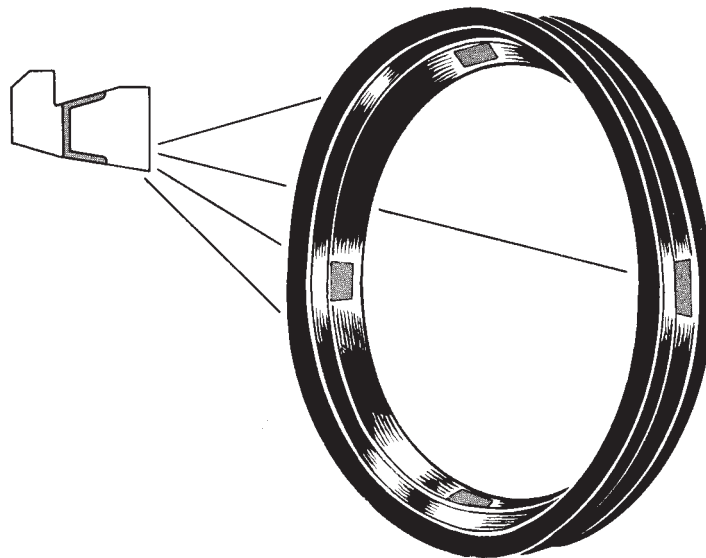

Fastite Conductive Gasket



AMERICAN DUCTILE IRON PIPE

AMERICAN Mechanical Joint Pipe For Water, Sewage or Other Liquids

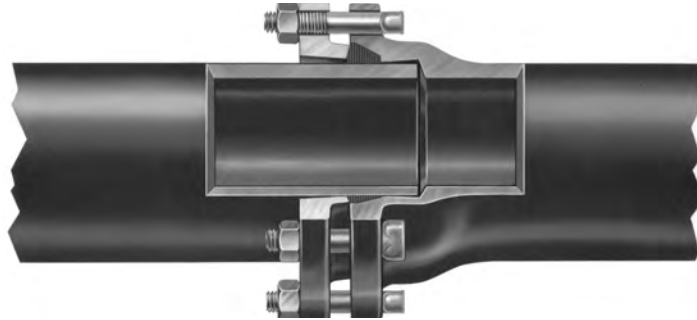

The AMERICAN Mechanical Joint was developed by the American Cast Iron Pipe Company and first marketed in 1929. Since that time, millions of feet of AMERICAN pipe equipped with this joint have been installed to give dependable service across the nation and in many foreign countries. The joint is designed with a stuffing box into which a rubber gasket is compressed by a ductile iron gland drawn up with low-alloy steel bolts. It affords liberal deflection and allows expansion and contraction of the line without leakage. It is rated for a water working pressure of up to 350 psi.

Originally designed to meet the rigid requirements of the gas industry for a pressure-tight joint, the AMERICAN Mechanical Joint was instrumental in starting a nationwide trend toward rubber-packed joints for water service as well as gas service. Its design was widely accepted and it soon became the standardized mechanical joint of the cast iron pipe industry. The popularity of the AMERICAN Mechanical

Joint among utility officials, contractors and engineers steadily increased until the majority of cast iron piping furnished for gas, water, sewage and other services was equipped with this joint. However, push-on joint pipes, which are less labor intensive and reliant with push-on or mechanical joint fittings, currently make up the vast majority of ductile iron pipelines being installed for underground service. Mechanical joint pipe is now used to a much lesser extent.

The AMERICAN Mechanical Joint meets the requirements of ANSI/AWWA C110/A21.10 and ANSI/AWWA C111/A21.11.

AMERICAN Ductile Iron Mechanical Joint Pipe is centrifugally cast in nominal 18' or 20' laying lengths, depending on size, under rigid production and quality control procedures in accordance with ANSI/AWWA Standards. AMERICAN Mechanical Joint Ductile Iron Pipe is available in 4" -12" sizes and in Special Thickness Classes 53 and higher.



The AMERICAN Mechanical Joint provides easy installation under the most adverse conditions. Plain rubber gaskets of SBR are normally used for water and domestic sewage service. Fabric tipped plain rubber gaskets are available, as well as other special gaskets such as oil-resistant rubber. Plain rubber gaskets or tipped gaskets are used for air or liquid temperatures up to 120°F. For applications involving temperatures in excess of 120°F, or for other spe-

cial service applications, and for installations in contaminated soils where permeation through gaskets might be a concern, consult AMERICAN for recommendations. See Table No. 2-6.

Standard joint accessories furnished with mechanical joint pipe and fittings include ductile iron glands, low-alloy steel tee head bolts with hex nuts and plain rubber gaskets. The cost of these accessories is normally included in the price of the pipe or fittings.

Mechanical Joint Gaskets

Table No. 2-6

| Common Name or Trade Name* | Chemical Name | Maximum Service Temperature** | | Common Uses |
|---|----------------------------------|-------------------------------|-------|---|
| | | Water & Sewer | Air | |
| Plain Rubber | Styrene Butadiene Copolymer(SBR) | 150°F | 125°F | Fresh Water, Salt Water, Sanitary Sewage |
| Neoprene | Polychloroprene(CR) | 200°F | 150°F | Fresh Water, Sewage |
| Fluoroelastomer Fluorel Viton®*** | FKM | 212°F | 300°F | Aromatic Hydrocarbons, Gasoline, Refined Petroleum Products, most Chemicals and Solvents, High Temp., Air (Least permeable of all available Fastite gasket rubbers) |
| Buna-N Nitrile | Acrylonitrile Butadiene(NBR) | 150°F | 125°F | Non-Aromatic Hydrocarbons, Petroleum Oil, Hydraulic Fluids, Fuel Oil, Fats, Oil, Grease† |
| EPDM | Ethylene Propylene Diene Monomer | 212°F | 150°F | Water, Sewage, Ketones, Dilute Acids and Alkalies, Vegetable Oil, Alcohols, Air |

*AMERICAN reserves the right to furnish any Trade or Brand rubber for the chemical formulation specified.

Temperature is in reference to conveyed fluid. **Lubricating oil in air can adversely affect SBR and EPDM performance. SBR, Nitrile and Neoprene are not recommended for hot air exposure in wastewater treatment systems.

Gaskets shown for use in "Sanitary Sewage" service are also suitable for use with sewage gas.

Refer to Section 11 for temperature and service capabilities of pipe linings.

Refer other special requirements to AMERICAN for recommendation regarding suitable gasket material.

***Viton® is a registered trademark of DuPont Dow Elastomers.

Note that temperature ratings of MJ gaskets per Table No. 2-6 are in some cases lower than the ratings for similar material Fastite gaskets (see Table No. 2-1, pg. 2-7). The designer may wish to consider the use of Fastite pipe and fittings in high-temperature applications.

All MJ gaskets made from the materials in the above table are suitable for use with water containing normal concentrations of chloramine. Where increased resistance to chloramine is desired, neoprene or fluoroelastomer materials should be considered.

†This gasket rubber is **chemically resistant** for the non-potable water uses shown, but NBR is not as resistant to permeation in potable water applications as FKM.



American Mechanical Joint
ANSI/AWWA C111/A21.11 Standard Dimensions

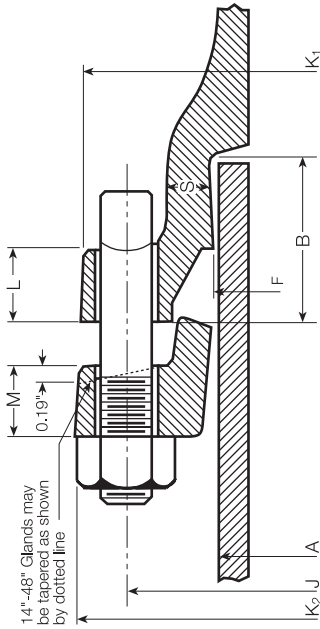

Table No. 2-7

| Size in. | Dimensions in Inches | | | | | | | | | | | |
|----------|----------------------|------|-------|-------|------------------|----------|----------------|------------------|----------|------|------------------|----------|
| | A Plain End | B | F | J | K ₁ | | K ₂ | L | | M | S | |
| | | | | | Centrifugal Pipe | Fittings | | Centrifugal Pipe | Fittings | | Centrifugal Pipe | Fittings |
| * 2 | 2.50 | 2.50 | 2.61 | 4.75 | 6.00 | 6.25 | 6.25 | .56 | .75 | .62 | .37 | .44 |
| * 2 1/4 | 2.75 | 2.50 | 2.86 | 5.00 | 6.25 | 6.50 | 6.50 | .56 | .75 | .62 | .37 | .44 |
| * 3 | 3.96 | 2.50 | 4.06 | 6.19 | 7.62 | 7.69 | 7.69 | .87 | .94 | .62 | .40 | .52 |
| 4 | 4.80 | 2.50 | 4.90 | 7.50 | 9.06 | 9.38 | 9.12 | .91 | 1.00 | .75 | .41 | .65 |
| 6 | 6.90 | 2.50 | 7.00 | 9.50 | 11.06 | 11.31 | 11.12 | .94 | 1.06 | .88 | .43 | .70 |
| 8 | 9.05 | 2.50 | 9.15 | 11.75 | 13.31 | 13.63 | 13.37 | .98 | 1.12 | 1.00 | .45 | .75 |
| 10 | 11.10 | 2.50 | 11.20 | 14.00 | 15.62 | 15.81 | 15.62 | .98 | 1.19 | 1.00 | .47 | .80 |
| 12 | 13.20 | 2.50 | 13.30 | 16.25 | 17.88 | 18.06 | 17.88 | .98 | 1.25 | 1.00 | .49 | .85 |
| 14 | 15.30 | 3.50 | 15.44 | 18.75 | 20.25 | 20.69 | 20.25 | 1.02 | 1.31 | 1.25 | .51 | .89 |
| 16 | 17.40 | 3.50 | 17.54 | 21.00 | 22.50 | 22.94 | 22.50 | 1.08 | 1.38 | 1.31 | .52 | .97 |
| 18 | 19.50 | 3.50 | 19.64 | 23.25 | 24.75 | 25.28 | 24.75 | 1.14 | 1.44 | 1.38 | .53 | 1.05 |
| 20 | 21.60 | 3.50 | 21.74 | 25.50 | 27.00 | 27.08 | 27.00 | 1.20 | 1.50 | 1.44 | .54 | 1.12 |
| 24 | 25.80 | 3.50 | 25.94 | 30.00 | 31.50 | 31.75 | 31.50 | 1.26 | 1.62 | 1.56 | .56 | 1.22 |
| 30 | 32.00 | 4.00 | 32.17 | 36.88 | ** | 39.12 | 39.12 | ** | 1.81 | 2.00 | ** | 1.50 |
| 36 | 38.30 | 4.00 | 38.47 | 43.75 | ** | 46.00 | 46.00 | ** | 2.00 | 2.00 | ** | 1.80 |
| 42 | 44.50 | 4.00 | 44.67 | 50.62 | ** | 53.12 | 53.12 | ** | 2.00 | 2.00 | ** | 1.95 |
| 48 | 50.80 | 4.00 | 50.97 | 57.50 | ** | 60.00 | 60.00 | ** | 2.00 | 2.00 | ** | 2.20 |

*2", 2 1/4" and 3" sizes of pipe are no longer manufactured by AMERICAN and dimensions are given for information only. 2" and 2 1/4" sizes are not shown in AWWA C111.
 **1.4"-48" Mechanical Joints are not available on centrifugal pipe.
 The ductile iron pipe bell flanges are in accordance with AWWA C111 which also provides that thicker bell flanges may be furnished.
 For additional information and tolerances see AWWA C111.
 Bolt Holes are 1/8" larger than the bolt diameters. See Table No. 2-8.
 Weights and classes for ductile iron pipe are given in Section 3.



AMERICAN Mechanical Joint Accessories

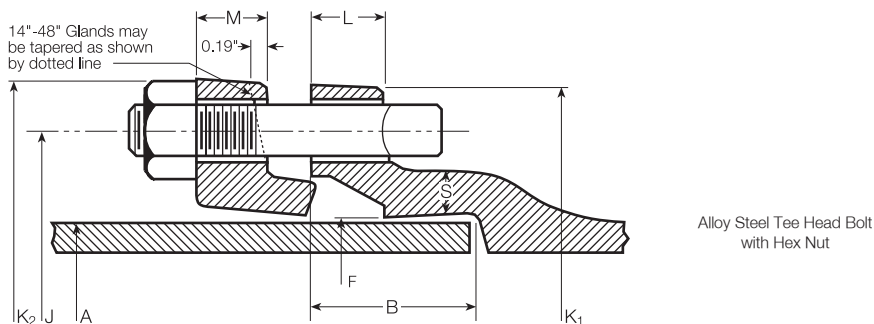

Table No. 2-8

| Size in. | Bolts | | Weight in Pounds | | | |
|----------|---------------|---------------|------------------|-------|---------|---------------------|
| | No. Per Joint | Size in. | Bolts Total | Gland | Gasket† | One Set Accessories |
| 4 | 4 | 3/4 x 3 1/2 | 3 | 6 | .42 | 10 |
| 6 | 6 | 3/4 x 3 1/2 | 5 | 11 | .59 | 17 |
| 8 | 6 | 3/4 x 4 | 5 | 18 | .75 | 24 |
| 10 | 8 | 3/4 x 4 | 7 | 20 | .92 | 28 |
| 12 | 8 | 3/4 x 4 | 7 | 30 | 1.09 | 39 |
| 14 | 10 | 3/4 x 4 1/2 | 9 | 35 | 1.23 | 46 |
| 16 | 12 | 3/4 x 4 1/2 | 11 | 45 | 1.42 | 58 |
| 18 | 12 | 3/4 x 4 1/2 | 11 | 55 | 1.56 | 68 |
| 20 | 14 | 3/4 x 4 1/2 | 13 | 70 | 1.77 | 85 |
| 24 | 16 | 3/4 x 5 | 15 | 90 | 2.13 | 108 |
| 30* | 20 | 1 x 6 | 41 | 180 | 4.16 | 225 |
| 36* | 24 | 1 x 6 | 49 | 235 | 4.81 | 289 |
| 42* | 28 | 1 1/4 x 6 1/2 | 99 | 300 | 5.77 | 405 |
| 48* | 32 | 1 1/4 x 6 1/2 | 113 | 365 | 6.52 | 485 |
| 54** | 36 | 1 1/4 x 6 1/2 | 127 | 360 | 7.30 | 494 |

AMERICAN no longer manufactures 2", 2 1/4" and 3" sizes of pipe; bolts required per joint for 2" and 2 1/4" sizes were 2 5/8" x 2 1/2", and for 3" size were 4 5/8" x 3".

Bolts used with mechanical joint retainer glands may be required by the manufacturers of those devices to be longer than shown above.

When required and when used with bell flanges "tapped for studs," stud bolts in lieu of Tee Head bolts are normally ordered of the same length of the Tee Head bolts they replace (See pages 2-24 and 2-25).

†Gasket weights shown here are for standard SBR rubber; other available rubber types are shown on page 2-17.

**14"-48" mechanical joints are for fittings only.

**54" Mechanical Joints are used only with special mechanical joint sleeves. This size is not in AWWA C110.



AMERICAN Mechanical Joint Pipe Allowable Joint Deflection

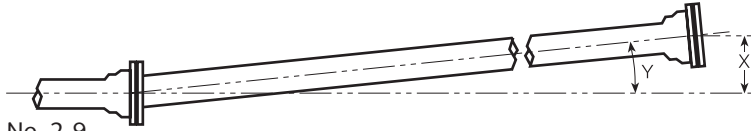

Table No. 2-9

| Size in. | Nominal Laying Length ft. | Maximum Recommended Deflection | | |
|----------|---------------------------|------------------------------------|-----------------------|-------------------------|
| | | X Offset per Nominal Length in. | Y Deflection Angle | Radius of Curve* ft. |
| 4 | 18 | 31 | 8°-18' | 124 |
| 6 | 20 | 30 | 7°-07' | 160 |
| 8 | 20 | 22 | 5°-21' | 220 |
| 10 | 20 | 22 | 5°-21' | 220 |
| 12 | 20 | 22 | 5°-21' | 220 |
| 14 | ** | ** | 3°-35' | ** |
| 16 | ** | ** | 3°-35' | ** |
| 18 | ** | ** | 3°-00' | ** |
| 20 | ** | ** | 3°-00' | ** |
| 24 | ** | ** | 2°-23' | ** |
| 30 | ** | ** | 2°-23' | ** |
| 36 | ** | ** | 2°-05' | ** |
| 42 | ** | ** | 2°-00' | ** |
| 48 | ** | ** | 2°-00' | ** |

*Approximate radius of curve produced by a succession of nominal lengths of pipe fully deflected. A shorter radius can be obtained using shorter pipes.

The joint should be assembled with the pipe in reasonably straight alignment. Joint deflection to the maximum shown above may be made after assembly but before tightening bolts. Offset distances are based on 18-ft or 20-ft lengths.

**14"-48" Mechanical Joints are provided on fittings and valves only.

Maximum Allowable Separation

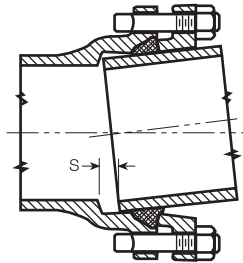
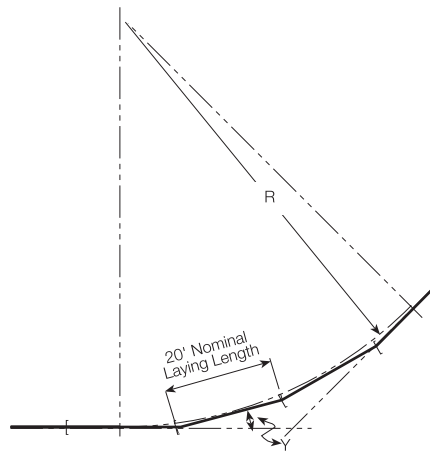

Table No. 2-10

| Size in. | S Separation in. |
|----------|---------------------|
| 24 | 1 |
| 30 | 1 1/4 |
| 36 | 1 3/8 |
| 42 | 1 1/2 |
| 48 | 1 3/4 |

Maximum Allowable Separation, "S", is provided for information only and should not be used to determine precise joint deflection.



R = Radius of Curve (ft.)

Y = Deflection Angle (degrees)

$$\text{Radius of Curve} = \frac{\text{Nominal Laying Length}}{2 \times \text{Tangent } (Y/2)}$$



**AMERICAN Mechanical Joint Pipe
Assembly Instructions**

The AMERICAN Mechanical Joint is the Standardized Mechanical Joint per AWWA C111. Assembly of the Mechanical Joint is pictured and described below.

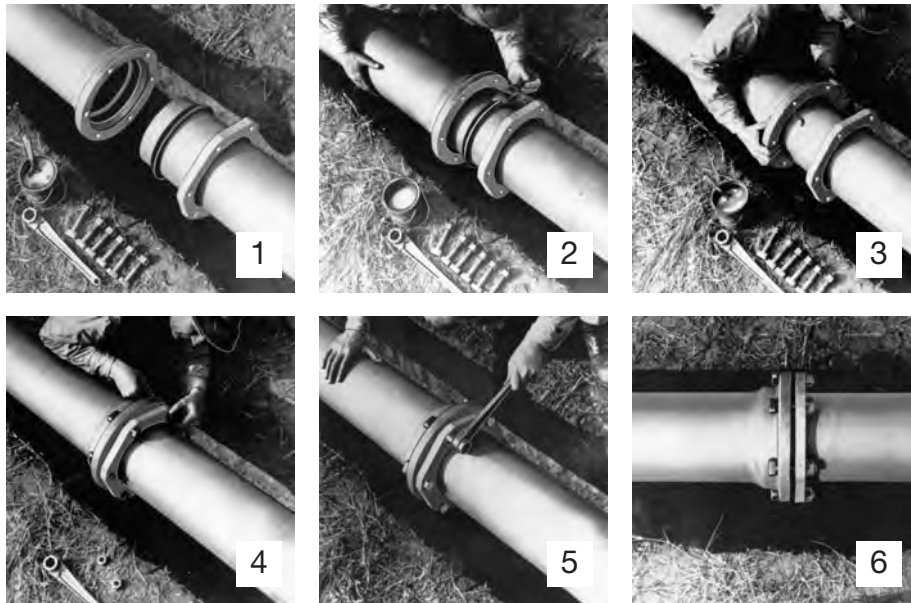

1. Thoroughly clean socket and plain end of all rust or foreign material; slip the gland over plain end with the lip extension toward plain end, followed by the gasket with thick section facing the gland. Gaskets to be installed during very cold weather should be warmed first.*

2. **Lubricate** socket, gasket and plain end with soapy water or an approved pipe lubricant meeting requirements of AWWA C111.

3. Insert plain end into socket and push gasket into position, making sure it is evenly seated in socket.

4. Slide gland into position, insert bolts and run nuts up finger-tight.

5. Tighten bolts to draw gland toward the pipe flange evenly, maintaining approximately the same distance between the gland and the face of the flange at all points around the joint. This may be achieved by partially tightening the bottom bolt first; then the top bolt; next, the bolts at either side; and, finally, the remaining bolts. This process should be repeated un-

til all bolts are within the range of torques shown. **In larger sizes (30"-48")**, as many as 5 or more repetitions may be required.

6. The completed joint.

It is recommended that the torque be applied with torque-measuring wrenches. The approximate torque can be applied by a man trained to give an average pull on a specific length regular ratchet wrench; for 5/8" bolt, length of wrench is 8"; for 3/4" bolt, 10"; for 1" bolt, 14"; and for 1 1/4" bolt, 16". **Torque so applied should be checked with torque-measuring wrenches. *Gaskets not used immediately should be stored in a cool location, out of direct sunlight.**

Table No. 2-11

| Pipe Size† in. | Bolt Diameter in. | Range of Torque Ft.-Lbs |
|-------------------|----------------------|-------------------------------|
| 4-24 | 3/4 | 75-90 |
| 30-36 | 1 | 100-120 |
| 42-48 | 1 1/4 | 120-150 |

† 14"-48" Mechanical Joints are provided on fittings and valves only.



AMERICAN Grooved and Shouldered Joints
AMERICAN Grooved Joint
AWWA C606

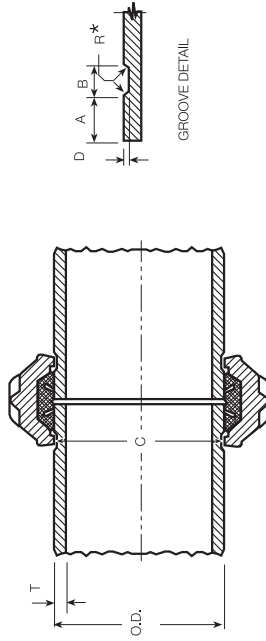

Table No. 2-12

| Size in. | O.D. | T** Nominal Wall Thickness | Coupling Max. Working Pressure† psi | A | | B | C | D | | Min. Length Grooved End Pipe in. | Weight in Pounds | |
|-------------|-------|----------------------------------|--|-------------------|----------------|------|--------|------|------|---|-----------------------------------|----------------------------|
| | | | | Flexible Joint | Rigid Joint | | | Min. | Max. | | Per Foot (Without Coupling) | Per Maximum†† Length |
| 4 | 4.80 | .32 | 500 | .750 | .840 | .375 | 4.563 | .096 | .151 | 3 1/2 | 13.8 | 241 |
| 6 | 6.90 | .34 | 400 | .750 | .840 | .375 | 6.656 | .100 | .154 | 3 1/2 | 21.4 | 430 |
| 8 | 9.05 | .36 | 400 | .875 | .950 | .500 | 8.781 | .104 | .177 | 4 | 30.1 | 600 |
| 10 | 11.10 | .38 | 350 | .938 | 1.015 | .500 | 10.813 | .114 | .186 | 4 | 39.2 | 785 |
| 12 | 13.20 | .40 | 350 | .938 | 1.015 | .500 | 12.906 | .117 | .192 | 4 | 49.2 | 985 |
| 14 | 15.30 | .42 | 250 | .938 | 1.015 | .625 | 14.969 | .126 | .206 | 4 1/4 | 60.1 | 1200 |
| 16 | 17.40 | .43 | 250 | 1.188 | 1.340 | .625 | 17.063 | .128 | .208 | 5 | 70.1 | 1410 |
| 18 | 19.50 | .44 | 250 | 1.188 | 1.340 | .625 | 19.125 | .148 | .228 | 5 | 80.6 | 1610 |
| 20 | 21.60 | .45 | 150 | 1.188 | 1.340 | .625 | 21.219 | .150 | .230 | 5 | 91.5 | 1830 |
| 24 | 25.80 | .47 | 150 | 1.188 | 1.340 | .625 | 25.406 | .157 | .237 | 5 | 114.4 | 2290 |
| 30††† | 32.00 | .51 | 150 | 1.375 | 1.625 | .750 | 31.550 | .195 | — | 6 | 154.4 | 3010 |
| 36††† | 38.30 | .58 | 150 | 1.375 | 1.625 | .750 | 37.850 | .195 | — | 6 | 210.3 | 4100 |

**R" for sizes 4" and 6" is .120"; for 8"-12" is .145"; for 14" and 16" is .165"; for 18"-24" is .185"; and for 30" and 36" is .215".
 **Minimum nominal wall thickness of centrifugally cast ductile iron pipe furnished with Grooved Joint. Thicknesses above correspond to Special Thickness Class 53 for all sizes.
 †Pressure ratings established by coupling manufacturer.
 ††Maximum length for 4" size is 17'6", for 6"-24" sizes is 20'0", and for 30"-36" sizes is 19'6".
 †††Shorter lengths than the maximum lengths can, of course, be furnished.
 †††30" and 36" sizes are not included in AWWA C606.

For tolerances see AWWA C606.
 Standard fittings are available with Grooved Joints and are normally available only with rigid grooving.
 Couplings for Grooved Joints may be furnished by AMERICAN but are not of our design or manufacture. Check AMERICAN for details and recommendations.



AMERICAN Shouldered Joint*
AWWA C606

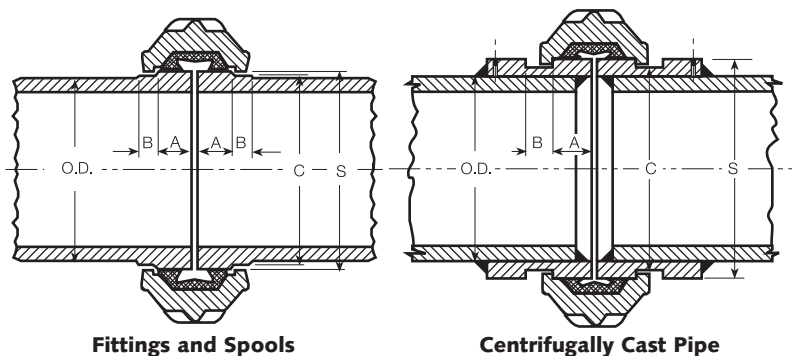

Table No. 2-13

| Size in. | Dimensions in Inches | | | | | Coupling Max. Working Pressure** |
|----------|----------------------|-------|--------|--------|--------|----------------------------------|
| | O.D. | A | B Min. | C Max | S | |
| 18 | 19.50 | 1.188 | .750 | 20.469 | 20.937 | 175 |
| 20 | 21.60 | 1.188 | .750 | 22.344 | 22.875 | 175 |
| 24 | 25.80 | 1.188 | .750 | 26.594 | 27.125 | 175 |
| 30 | 32.00 | 1.750 | 1.000 | 33.000 | 33.750 | 175 |
| 36 | 38.30 | 1.750 | 1.000 | 39.438 | 40.188 | 175 |
| 42 | 44.50 | 1.750 | 1.250 | 45.813 | 46.625 | 175 |
| 48 | 50.80 | 1.750 | 1.250 | 52.188 | 53.125 | 175 |
| 54 | 57.56 | 1.750 | 1.500 | 58.625 | 59.688 | 175 |
| 60 | 61.61 | 1.750 | 1.500 | 63.625 | 64.688 | 90 |
| 60 | 61.61 | 1.750 | 1.500 | 65.063 | 66.188 | 175 |
| 64† | 65.67 | 1.750 | 1.500 | 69.625 | 70.750 | 90 |

*AMERICAN Shouldered Joints are furnished on fittings and on statically cast pipe as shown left above. On centrifugally cast pipe the Shouldered Joint is furnished with welded steel end ring fabricated as shown right above. Consult AMERICAN regarding specific requirements.

Wall thickness will vary according to service requirements and with method of casting—centrifugal or static.

Shouldered Joints with other dimensions can be furnished under certain circumstances. Check AMERICAN for details.

Couplings for Shouldered Joints are not designed or manufactured by AMERICAN, but may be furnished on request. Check AMERICAN for recommendations.

**Pressure rating established by coupling manufacturer.

†66" couplings are used with 64" pipe.

Welded rings can be furnished on minimum pressure classes of ductile iron pipe. Maximum laying length is 19'6" and minimum laying length is 1'6" for all sizes.

Check AMERICAN if smaller sizes of shouldered end pipes are desired.



**AMERICAN Bolted Joints
Tee Head Bolts**

Table No. 2-14

| Pipe Size in. | Mechanical Joint | | Mechanical Joint with Retainer Gland | | MJ Coupled Joint | |
|------------------|------------------|-------------|---|-------------|------------------|-------------|
| | No. | Size in. | No. | Size in. | No. | Size in. |
| 4 | 4 | 3/4x3 1/2 | 4 | 3/4x3 1/2 | 4 | 3/4x4 |
| 6 | 6 | 3/4x3 1/2 | 6 | 3/4x4 | 6 | 3/4x4 |
| 8 | 6 | 3/4x4 | 6 | 3/4x4 1/2 | 6 | 3/4x4 1/2 |
| 10 | 8 | 3/4x4 | 8 | 3/4x4 1/2 | 8 | 3/4x4 1/2 |
| 12 | 8 | 3/4x4 | 8 | 3/4x4 1/2 | 8 | 3/4x4 1/2 |
| 14 | 10 | 3/4x4 | 10 | 3/4x5 | 10 | 3/4x5 |
| 16 | 12 | 3/4x4 1/2 | 12 | 3/4x5 | 12 | 3/4x5 |
| 18 | 12 | 3/4x4 1/2 | 12 | 3/4x5 | 12 | 3/4x5 |
| 20 | 14 | 3/4x4 1/2 | 14 | 3/4x5 | 14 | 3/4x5 1/2 |
| 24 | 16 | 3/4x5 | 16 | 3/4x5 1/2 | 16 | 3/4x5 1/2 |
| 30* | 20 | 1 x6 | - | - | 20 | 1 x7 |
| 36* | 24 | 1 x6 | - | - | 24 | 1 x7 |
| 42* | 28 | 1 1/4x6 1/2 | - | - | 28 | 1 1/4x7 |
| 48* | 32 | 1 1/4x6 1/2 | - | - | 32 | 1 1/4x7 |

*14"-48" Mechanical Joints are furnished on fittings only.

Boxing of Tee Head Bolts†

Tee Head Bolts with Hex Nuts are boxed with the following number per box (per each weight of bolt and nut shown in parentheses):

| | | | | | | |
|-------------|------------|-------------|------------|-------------------|-----------|-------------------------|
| 5/8 x 3 | (.48)-375 | 3/4 x 6 1/2 | (1.11)-125 | 1 x 9 1/2 | (3.00)-50 | } Boxed per order |
| 3/4 x 3 1/2 | (.80)-225 | 3/4 x 7 | (1.16)-100 | 1 1/4 x 6 | (3.40)-50 | |
| 3/4 x 4 | (.85)-200 | 3/4 x 8 | (1.33)-75 | 1 1/4 x 8 1/2 | (4.25)-40 | |
| 3/4 x 4 1/2 | (.91)-175 | 1 x 5 | (1.86)-100 | †† 1 1/4 x 13 1/2 | (6.25) | |
| 3/4 x 5 | (.96)-175 | 1 x 6 | (2.06)-75 | 1/2 x 8 1/2 | (6.75) | |
| 3/4 x 5 1/2 | (1.01)-150 | 1 x 7 | (2.26)-75 | 1/2 x 10 | (7.65) | |
| 3/4 x 6 | (1.06)-150 | 1 x 7 1/2 | (2.36)-75 | 1/2 x 11 | (8.25) | |

†Bolts and nuts of special sizes not routinely furnished by AMERICAN are also shown for information.

††Double nut stud, 4 1/2" minimum thread one end, 2" on other end.

Approximate unit weights, in pounds, of nuts only are as follows: 5/8"-.12; 3/4"-.19; 1"-.42; 1 1/4"-.80; 1 1/2"-1.40.

Bolts for 4"-48" MJ Joints are per AWWA C111.



AMERICAN Tee Head Bolts, Studs and Nuts Alloy Steel

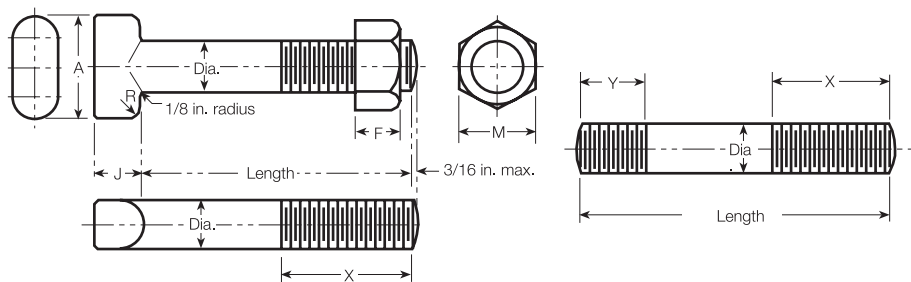

Tee Head Bolt

Stud Bolt

Table No. 2-15

| Tee Head Bolts and Stud Bolts | | | Dimensions in Inches | | | | | | |
|-------------------------------|------------|-------------------------|----------------------|-------|-------|-------|--------|------|------|
| Diameter in. | Length in. | No. of Threads Per Inch | A | F | H | J | R Max. | X | Y* |
| 3/4 | 3 1/2 | 10 | 1.75 | .750 | 1.250 | .750 | .375 | 2.50 | 1.00 |
| 3/4 | 4 | 10 | 1.75 | .750 | 1.250 | .750 | .375 | 3.00 | 1.00 |
| 3/4 | 4 1/2 | 10 | 1.75 | .750 | 1.250 | .750 | .375 | 3.00 | 1.31 |
| 3/4 | 5 | 10 | 1.75 | .750 | 1.250 | .750 | .375 | 3.00 | 1.63 |
| 3/4 | 5 1/2 | 10 | 1.75 | .750 | 1.250 | .750 | .375 | 3.00 | 1.63 |
| 1 | 6 | 8 | 2.25 | 1.000 | 1.625 | 1.000 | .500 | 3.00 | 1.75 |
| 1 | 7 | 8 | 2.25 | 1.000 | 1.625 | 1.000 | .500 | 4.00 | 2.00 |
| 1 1/4 | 6 | 7 | 2.50 | 1.250 | 2.000 | 1.250 | .625 | 3.00 | 2.00 |
| 1 1/4 | 6 1/2 | 7 | 2.50 | 1.250 | 2.000 | 1.250 | .625 | 3.50 | 2.00 |
| 1 1/4 | 7 | 7 | 2.50 | 1.250 | 2.000 | 1.250 | .625 | 4.00 | 2.00 |
| 1 1/4 | 8 1/4 | 7 | 2.50 | 1.250 | 2.000 | 1.250 | .625 | 4.50 | 2.00 |

*The "Y" Dimension is only applicable for standard mechanical joints.
 All threads are Coarse-Thread Series Class 2A, External and Class 2B, Internal, per ANSI B1.1.
 Threads are the same for bolts and studs.
 For tolerances see AWWA C111.
 Stud bolts with one nut are furnished when specified in lieu of Tee Head bolts, with the required Stud Bolt length normally equal to the length of the Tee Head bolt it replaces.
 Nuts are furnished in accordance with ASTM A563, Standard Specification for Carbon and Alloy Steel Nuts.



AMERICAN DUCTILE IRON PIPE

AMERICAN reserves the right to modify or change designs, materials, specifications, or dimensions shown herein without prior notice.

*This is a preprint of a section from the 19th Edition of the AMERICAN Pipe Manual.
References may be made in this section to other sections of this manual.*

Section 3

AMERICAN Ductile Iron Pipe





AMERICAN Ductile Iron Pipe Centrifugally Cast in Metal Molds or Sand-Lined Molds For Water or Other Liquids.

What is AMERICAN Ductile Iron?

The ideal of cast iron with ductility, long sought by metallurgists, was realized with the introduction of ductile iron in 1948. Acclaimed to be one of the most significant metallurgical developments in this century, ductile iron has had an increasing impact in many industries. Ductile iron has ductility—as the name implies—and in addition, it has strength and impact resistance far greater than that of gray iron; yet it retains the proven corrosion resistance of gray iron, thus making it an ideal piping material.

American Cast Iron Pipe Company pioneered in the development of ductile iron pipe and produced experimental casts of ductile pipe and fittings as early as 1948. In 1949 Mr. C.K. Donoho, AMERICAN's chief metallurgist, authored a paper on

the amazing properties of this new metal. Following this experimental work, the first shipment of AMERICAN Ductile Iron pipe was made in 1955. Production of ductile iron pipe has grown steadily and it is now a predominant piping material for conveying water and other liquids.

Ductile iron is produced by treating molten low-sulfur base iron with magnesium under closely controlled conditions. The startling change in the metal is characterized by the free graphite in ductile iron being deposited in spheroidal or nodular form instead of flake form as in gray iron. With the free graphite in nodular form, the continuity of the metal matrix is at a maximum, accounting for the formation of a far stronger, tougher ductile material greatly exceeding gray iron in strength, in ductility, and in impact characteristics.



Photomicrograph showing graphite form in gray iron.

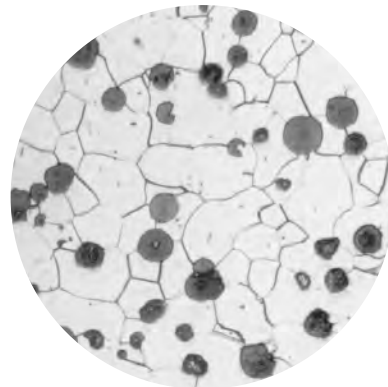

Photomicrograph showing graphite form in ductile iron.

AMERICAN Ductile Iron-Grade 60-42-10

Minimum Physical Properties
AWWA C151

These properties are verified by tensile samples taken from the wall of the pipe.

| | |
|-----------------------|------------|
| Tensile Strength..... | 60,000 psi |
| Yield Strength..... | 42,000 psi |
| Elongation..... | 10 percent |

Fig. 3-1



AMERICAN DUCTILE IRON PIPE

AMERICAN Ductile Iron pipe provides...

High Impact Resistance

AMERICAN Ductile Iron pipe has the high impact strength and toughness to withstand shocks usually encountered in transportation, handling and installation. These characteristics also provide added security against stresses induced by water hammer, highway traffic and unexpected adverse forces. Excellent impact resistance is confirmed by tests made at regular intervals in accordance with ANSI/AWWA C151/A21.51 Standard.

Superior Strength

AMERICAN utilizes the ideal combination of chemical analysis and heat treatment to produce a pipe with the most desirable combination of high strength and excellent ductility...a pipe that will withstand high internal pressure and deep cover...a pipe providing added reliability and additional factors of safety for normal and for unusual conditions such as expansive soils and earth movement due to freezing and thawing.

Conservation of Energy and Lower Pumping Costs

Head losses in piping are directly related to inside diameters, and energy consumption and accompanying pumping costs are directly related to head losses. Therefore, the use of ductile iron piping having inside diameters greater than nominal can result in significant energy savings over the years. In addition to helping to keep operating costs and utility rates reasonable, this conservation of energy is also helpful to the environment.

Assured, Proven Long Life

Historical records document the proven service for centuries of gray cast iron pipe. Extensive laboratory and field tests conducted by many authorities under various installation conditions prove the soil corrosion resistance of ductile iron is at least as good as, if not better than, that of gray cast iron. The outstanding resistance of ductile iron pipe to soil corrosion has been verified by more than four decades of service.



After receiving the full force of a 4,500 pound weight dropped from a height of 30 feet, this 30" AMERICAN Ductile Iron pipe was severely deformed but did not fail.

Design of AMERICAN Ductile Iron Pipe

The principal standards covering ductile iron pipe are ANSI/AWWA C150/A21.50 and ANSI/AWWA C151/A21.51. These and other standards are referenced throughout this Section either by the full ANSI/AWWA designation or by only the AWWA numbering, such as AWWA C150.

AMERICAN Ductile Iron pipe is designed for combinations of internal pressure, water hammer, earth load and truck load. Thicknesses are determined in accordance with ANSI/AWWA C150/A21.50, employing design methods applicable to flexible pipe. Utilizing the principal mechanical properties of high

tensile strength, ductility and impact resistance, the design of ductile iron pipe is conservative in all respects and embodies high factors of safety. For qualification of pipe these properties are confirmed during production by frequent tensile and impact tests of specimens from the wall of pipe.



Physical Properties

The ductile iron in AMERICAN pipe is grade 60-42-10, an annealed grade with the following specified minimum properties: tensile strength, 60,000 psi; yield strength, 42,000 psi; elongation, 10 percent.

A typical stress-strain curve obtained on a tensile specimen from the wall of ductile iron pipe shows that the pipe metal is an elastic material; that is, its stress-strain relation is linear over a substantial portion of the ultimate strength range. The average modulus of elasticity is 24,000,000 psi, the value used in the design equations. Beyond the yield point the metal continues to exhibit substantial ductility before ultimate failure.

The high tensile strength of ductile iron allows the use of diameter-to-thickness ratios in which the deflection of the pipe, under trench loads, is of sufficient magnitude that the principles of flexible pipe design are applicable.

Design Steps

1. Pipe is designed for internal pressure including working pressure and surge pressure as follows:

Working pressure is the specified design working pressure.

Surge pressure is 100 psi unless a different surge pressure is specified by the buyer or his engineer.

The design internal pressure in psi is the safety factor 2.0 multiplied by the sum of the working pressure and the surge pressure (100 psi). The metal design strength is the minimum yield strength in tension of 42,000 psi.

2. Pipe is designed for external loads including both earth load and truck load as follows:

Earth load is based on the prism load concept and normally conservative weight of backfill soil of 120 lb/cu.ft.

Truck load is based on an AASHTO H-20 truck with 16,000-lb wheel load and 1.5 impact factor considered at all depths for all sizes of pipe.

The ring bending stress used in design is 48,000 psi. The maximum pipe deflection used in the design of cement-lined pipe is 3%.

The design values for the five types of standard laying conditions in AWWA C150 and C151 (see Fig. 3-2, page 3-12) are as follows:

Type 1:
E' = 150 Bedding Angle = 30°

Type 2:
E' = 300 Bedding Angle = 45°

Type 3:
E' = 400 Bedding Angle = 60°

Type 4:
E' = 500 Bedding Angle = 90°

Type 5:
E' = 700 Bedding Angle = 150°

3. The larger net thickness is selected from the internal pressure design thickness and the bending stress design thickness. To this thickness is added a service allowance of 0.08". The minimum thickness for deflection is then calculated and compared to that thickness. The larger of the two is selected. A casting tolerance is then added, giving the total design thickness of the pipe. Casting tolerances are listed in Table No. 3-1.

4. The pressure class thickness is determined by the selection of a standard pressure class thickness from Table No. 3-8. If the calculated thickness is between two standard pressure class thicknesses, the larger of the two is selected.

Later in this Section, tables show thicknesses of ductile pipe for a number of different pressures and depths of cover. For conditions not covered in tables, all formulas and data for designing ductile iron pipe are given in AWWA C150.



Manufacture of AMERICAN Ductile Iron Pipe

AMERICAN Ductile Iron pipe is cast centrifugally in nominal 20-foot laying lengths by the deLavaud process.

After the careful proportioning of select high-quality raw materials, the melting of iron for the manufacture of AMERICAN Ductile Iron pipe takes place in one of the world's largest iron melting facilities under continually controlled conditions.

AMERICAN also owns and operates one of the most impressive and modern scrap recycling facilities in the world. This facility ensures a dependable supply of high-quality shredded ferrous scrap for the production of high-quality piping products, conserving valuable natural resources in the process. This means, unlike many other types of pipe materials, AMERICAN Ductile Iron pipe is manufactured using predominantly recycled iron and steel, not virgin materials.

The melting process utilizes a control computer in the operation of the highly sophisticated electronic and mechanical components of the system. Rigid clean air requirements are satisfied through modern emission control equipment.

Molten iron flows from a Contiar furnace and/or cupola, and in the melting facility is collected in 60-ton capacity

ladles where it is desulfurized. From here the iron is transferred into a 1300-ton holder which provides a reservoir of iron of uniform chemistry. The molten iron is then transferred from the holder to coreless electric induction furnaces where chemistry and temperature are adjusted to the precise requirements of each production unit. The iron is then ready for treatment with magnesium, the most important step in the production of ductile iron, requiring close control of both the mechanics of the operation and the final chemistry of the iron. After treatment, each ladle is checked for exact content of magnesium and other elements, and the metal is sent to the production area for pouring.

The molten iron is introduced into a horizontal rotating mold with the quantity of the metal poured controlling the pipe thickness. The centrifugal force generated by rotation holds the metal against the mold wall and forces lighter, non-metallic impurities to the inside of the pipe to be removed in the cleaning process. After the iron has solidified, the casting machine is stopped and the pipe is stripped from the mold.

All AMERICAN Ductile Iron pipe is annealed in modern heat treating ovens

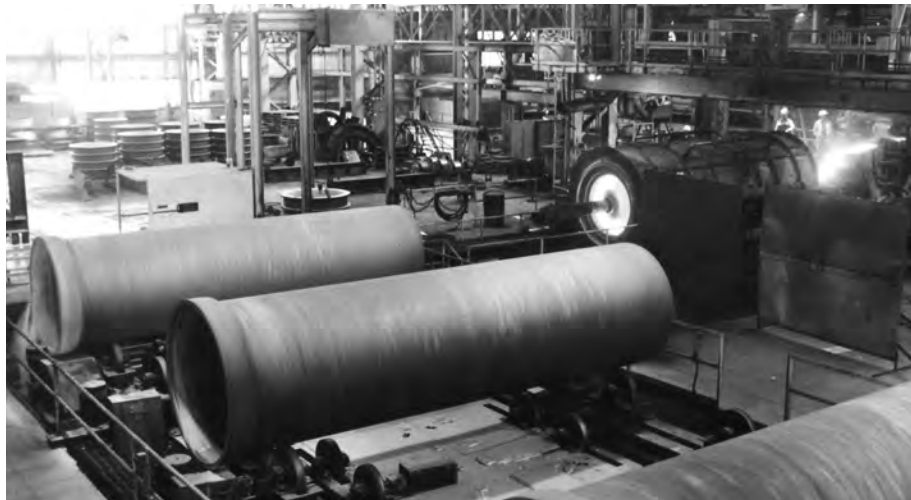

View of modern plant where the large-diameter sizes of pipe are centrifugally cast in nominal 20-foot lengths by the deLavaud process.



with precisely controlled time and temperature cycles to produce optimum physical properties. The pipe is then moved to processing stations where it is cleaned, machined, hydrostatically tested, lined and coated, and given final inspection.

AMERICAN Ductile Iron pipe in sizes 4" through 64" is manufactured in accordance with and meets or exceeds all applicable requirements of AWWA C151 Standard for "Ductile Iron Pipe, Centrifugally Cast, for Water or Other Liquids." The quality of AMERICAN's products and conformance to appropriate specifications is assured by the British Standards Institute's certification that AMERICAN's quality system complies with the ISO 9001 Quality Management System Standard.

GENERAL REQUIREMENTS

AMERICAN Ductile Iron pipe, with Fastite or mechanical joints, complies with AWWA C151 and the joints meet requirements of AWWA C111. The outside diameters of 4"-48" are the same as for gray iron pipe that was formerly manufactured per AWWA C106 or C108, making ductile iron pipe completely interchangeable with gray iron pipe made to those standards with respect to joining diameters, accessories and fittings.

The installation of ductile iron pipe is covered in AWWA C600, including general

instructions for the assembly of push-on and mechanical joint pipe. See Section 2 of this Pipe Manual for detailed assembly instructions for Fastite and Mechanical Joint pipe.

The nominal laying length of the pipe is as shown in tables in this Section. A maximum of 20 percent of the total number of pipes of each size specified in an order may be furnished as much as 24" shorter than the nominal laying length, and an additional 10 percent may be furnished as much as 6" shorter than nominal laying length.

Dimensions

The plain end, the socket of the pipe, and the accessories are gauged at sufficiently frequent intervals to ensure that the dimensions comply with the requirements of AWWA C151.

Thickness

Minus thickness tolerances of pipe are shown below:

Table No. 3-1

| Size in. | Minus Tolerance in. |
|----------|---------------------|
| 4"-8" | 0.05 |
| 10"-12" | 0.06 |
| 14"-42" | 0.07 |
| 48" | 0.08 |
| 54"-64" | 0.09 |



During production, each ladle of ductile iron is checked for exact content of magnesium and other elements with this computer-controlled optical emission spectrometer.



AMERICAN DUCTILE IRON PIPE

An additional minus tolerance of 0.02" is permitted along the barrel of the pipe for a distance not to exceed 12".

Weight

The weight tolerance of pipe is minus 6 percent for pipe 12" and smaller in diameter, and minus 5 percent for pipe larger than 12" in diameter.

COATINGS AND LININGS

Outside Coating

The outside coating for use under normal conditions is an asphaltic coating approximately 1 mil thick as specified in AWWA C151. The coating is applied to the outside of all pipe, unless otherwise specified. See Section 11.

Inside Lining

AMERICAN Ductile Iron pipe for water service is normally furnished with standard cement lining on the inside as specified in AWWA C104.

For other types of service, pipe can be furnished uncoated inside or with cement lining, asphaltic lining or with other linings as may be required to meet service conditions and as agreed upon at time of purchase.

For more detailed information on coatings and linings see Section 11.

TESTING

To ensure that the properties of the finished pipe meet or exceed the requirements of AWWA C151 and those of AMERICAN's quality control program, continuous inspection and testing are performed.

Spectral Analysis

Following magnesium treatment of the molten metal, a sample is poured from each ladle for spectral analysis. Within minutes, the amount of magnesium and other elements in the iron is determined. This early verification of the metal composition is a vital factor in the control of pipe quality.

Tensile Test

The physical characteristics of the pipe are continually checked by tensile tests made at a frequency of at least one such test during each casting period of approximately 3 hours. The tensile test specimens are cut from the pipe wall, and are machined from the midsection for testing. The acceptance values for test specimens are as follows:



Each 30" and larger diameter AMERICAN Ductile Iron pipe is hydrostatically tested to 75% of yield strength which results in higher test pressures than those required by AWWA C151, varying to over 900 psi, depending on size and thickness of the pipe.



Grade of Iron: 60-42-10

Minimum tensile strength.....60,000 psi
 Minimum yield strength.....42,000 psi
 Minimum elongation.....10 percent

Impact Test

Impact tests are made on at least one sample machined from the pipe wall during each operating hour to ensure the desired toughness in the finished pipe. Notched Charpy impact tests are performed in accordance with ASTM E23, except that specimen size is 0.500" by full thickness of the pipe wall. The corrected acceptance value for this test is a minimum of 7 ft-lb for tests conducted at 70°F ± 10°. Low-temperature impact tests are made from at least 10% of the test pipe to ensure compliance with a minimum corrected value of 3 ft-lb for tests conducted at -40°F ± 2°F.

Hydrostatic Test

As specified by AWWA C151, each pipe is subjected to a hydrostatic test of not less than 500 psi with the pipe under the full test pressure for at least 10 seconds. Suitable controls and recording devices are provided so that the test pressure and duration are positively controlled. Any pipe that leaks or does not withstand the test pressure is rejected.

For even greater assurance of pipe quality, each 30" and larger AMERICAN Ductile Iron pipe is hydrostatically tested to 75% of yield

strength of the metal, based on the nominal thickness of the pipe. As an example of the higher test pressures this dictates, each length of 30" diameter ductile iron pipe, Class 150 (the lightest class produced), 0.34" nominal wall, is tested to 669 psi. See Table No. 3-2 for a listing of AMERICAN's hydrostatic tests on 30" and larger pressure class pipe. Contact AMERICAN if higher test pressures are desired.

Hardness Test

Hardness tests of pipe samples are routinely made to further ensure the quality of the final product.

MARKING PIPE

The weight, class or nominal thickness, and casting period are shown on each pipe. AMERICAN's identifying mark, the year in which the pipe is produced, and the letters "DI" or "DUCTILE" are cast or stamped on the pipe. When specified on the purchase order, initials not exceeding four in number are stamped on the pipe. All marks are on or near the bell.

WEIGHING PIPE

Each pipe is weighed before the application of any lining or coating other than the asphaltic coating. The weight is painted on the outside of the bell end.

**AMERICAN Ductile Iron Pipe
 Hydrostatic Proof Test Pressures
 30"-64" Pressure Classes**

Table No. 3-2

| Size in. | Outside Diameter in. | Pressure Class | | | | | | | | | |
|----------|----------------------|--------------------|-------------------|--------------------|-------------------|--------------------|-------------------|--------------------|-------------------|--------------------|-------------------|
| | | 150 | | 200 | | 250 | | 300 | | 350 | |
| | | Wall Thickness in. | Test Pressure psi | Wall Thickness in. | Test Pressure psi | Wall Thickness in. | Test Pressure psi | Wall Thickness in. | Test Pressure psi | Wall Thickness in. | Test Pressure psi |
| 30 | 32.00 | 0.34 | 669 | 0.38 | 748 | 0.42 | 827 | 0.45 | 886 | 0.49 | 965 |
| 36 | 38.30 | 0.38 | 625 | 0.42 | 691 | 0.47 | 773 | 0.51 | 839 | 0.56 | 921 |
| 42 | 44.50 | 0.41 | 580 | 0.47 | 665 | 0.52 | 736 | 0.57 | 807 | 0.63 | 892 |
| 48 | 50.80 | 0.46 | 570 | 0.52 | 645 | 0.58 | 719 | 0.64 | 794 | 0.70 | 868 |
| 54 | 57.56 | 0.51 | 558 | 0.58 | 635 | 0.65 | 711 | 0.72 | 788 | 0.79 | 865 |
| 60 | 61.61 | 0.54 | 552 | 0.61 | 624 | 0.68 | 695 | 0.76 | 777 | 0.83 | 849 |
| 64 | 65.67 | 0.56 | 537 | 0.64 | 614 | 0.72 | 691 | 0.80 | 767 | 0.87 | 835 |

These pressures produce a 31,500 psi stress in the pipe wall (which is equal to 75% of the 42,000 psi minimum yield strength for ductile iron pipe) based on outside diameter and total standard thickness. Test pressure = 2 x T x 31,500 / O.D.



AMERICAN DUCTILE IRON PIPE

**AMERICAN Ductile Iron Fastite® Joint Pipe
ANSI/AWWA C151/A21.51
Standard Dimensions**

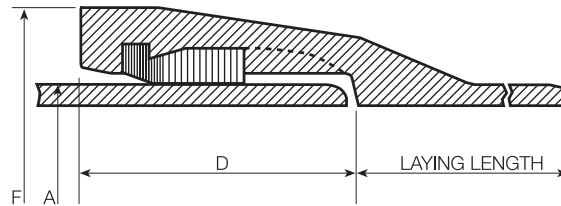

Table No. 3-3

| Size in. | Nominal Laying Length ft. | Dimensions in Inches | | |
|----------|---------------------------|----------------------|-------------------|--------------|
| | | A Outside Diameter | D Depth of Socket | F* Bell O.D. |
| 4 | 20 | 4.80 | 3.31 | 6.40 |
| 6 | 20 | 6.90 | 3.38 | 8.60 |
| 8 | 20 | 9.05 | 3.75 | 10.96 |
| 10 | 20 | 11.10 | 3.75 | 13.12 |
| 12 | 20 | 13.20 | 3.75 | 15.22 |
| 14 | 20 | 15.30 | 5.23 | 17.61 |
| 16 | 20 | 17.40 | 5.23 | 19.74 |
| 18 | 20 | 19.50 | 5.50 | 22.16 |
| 20 | 20 | 21.60 | 5.50 | 24.28 |
| 24 | 20 | 25.80 | 5.50 | 28.50 |
| 30 | 20 | 32.00 | 6.50 | 34.95 |
| 36 | 20 | 38.30 | 6.50 | 41.37 |
| 42 | 20 | 44.50 | 7.50 | 48.27 |
| 48 | 20 | 50.80 | 8.00 | 54.71 |
| 54 | 20 | 57.56 | 8.50 | 61.65 |
| 60 | 20 | 61.61 | 8.75 | 65.80 |
| 64 | 20 | 65.67 | 9.00 | 70.04 |

*Dimensions subject to change at our option. Check AMERICAN if exact dimensions required. For Fastite assembly instructions see Section 2.



The liberal allowable deflection in the Fastite Joint facilitates pipeline installation with sweeping horizontal or vertical curves without the use of fittings.



AMERICAN Ductile Iron Fastite® Joint Pipe
Allowable Joint Deflection

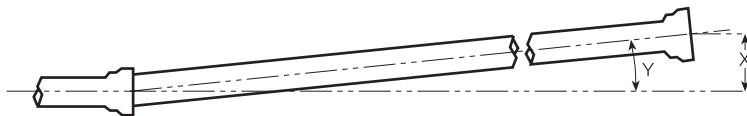

Table No. 3-4

| Size in. | Nominal Laying Length ft. | Maximum Recommended Deflection | |
|-------------|---------------------------------|--------------------------------------|------------------------------------|
| | | X Offset per Nominal Length (in.) | Y Deflection Angle (degrees) |
| 4 | 20 | 21 | 5° |
| 6 | 20 | 21 | 5° |
| 8 | 20 | 21 | 5° |
| 10 | 20 | 21 | 5° |
| 12 | 20 | 21 | 5° |
| 14 | 20 | 21 | 5° |
| 16 | 20 | 21 | 5° |
| 18 | 20 | 21 | 5° |
| 20 | 20 | 21 | 5° |
| 24 | 20 | 21 | 5° |
| 30 | 20 | 21 | 5° |
| 36 | 20 | 17 | 4° |
| 42 | 20 | 12 | 3° |
| 48 | 20 | 12 | 3° |
| 54 | 20 | 12 | 3° |
| 60 | 20 | 12 | 3° |
| 64 | 20 | 12 | 3° |

For optimum assembly, the joints should be assembled with the pipe in reasonably straight alignment. After joint assembly, the pipe may be deflected up to the maximum shown above. Offset distances are based on nominal lengths shown.

See Section 2 Table 2-4 for maximum allowable internal separation of 24" and larger Fastite joints.

Special Fastite Deflection Bells

Special Fastite bells are available
 which allow greater maximum joint
 deflection as follows:

Table No. 3-5

| Size in. | X Offset per Length in. | Y Deflection Angle |
|-------------|----------------------------------|--------------------------|
| 36 | 21 | 5° |
| 42 | 21 | 5° |
| 48 | 17 | 4° |
| 54 | 17 | 4° |
| 60 | 17 | 4° |
| 64 | 17 | 4° |

Offset distances are for 36"-64" Special Deflection Bells based on 20-foot lengths.



AMERICAN Ductile Iron Mechanical Joint Pipe*
ANSI/AWWA C151/A21.51
Standard Dimensions

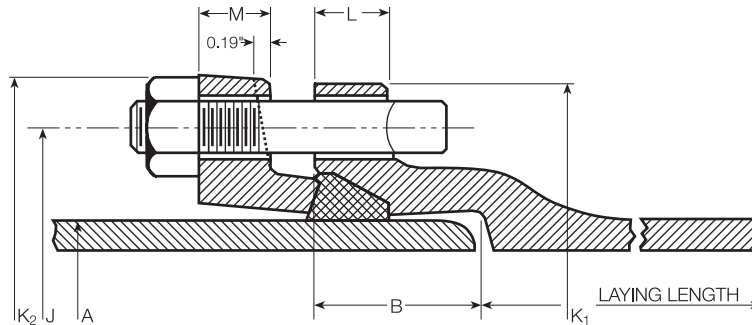

Table No. 3-6

| Size in. | Nominal Laying Length ft. | Dimensions in Inches | | | | | | | Bolts | |
|----------|---------------------------|----------------------|-----|-------|-------------------|----------------|----------------|------|---------------|----------|
| | | A | B | J | K ₁ ** | K ₂ | L _† | M | No. per Joint | Size in. |
| 4 | 20 | 4.80 | 2.5 | 7.50 | 9.06 | 9.12 | .91 | .75 | 4 | ¼ X 3½ |
| 6 | 20 | 6.90 | 2.5 | 9.50 | 11.06 | 11.12 | .94 | .88 | 6 | ¼ X 3½ |
| 8 | 20 | 9.05 | 2.5 | 11.75 | 13.31 | 13.37 | .98 | 1.00 | 6 | ¼ X 4 |
| 10 | 20 | 11.10 | 2.5 | 14.00 | 15.62 | 15.62 | .98 | 1.00 | 8 | ¼ X 4 |
| 12 | 20 | 13.20 | 2.5 | 16.25 | 17.88 | 17.88 | .98 | 1.00 | 8 | ¼ X 4 |

*Mechanical Joint Pipe is available in Special Thickness Class 53 only.

**These dimensions for pipe only. Refer to Table No. 5-1 for fitting joint dimensions.

†The bell flanges may be furnished thicker than specified under "L" above as provided in AWWA C111.

Bolt holes are 1/8" larger than bolt diameters.

For Mechanical Joint assembly instructions and for additional dimensions see Section 2.

See Section 12 when retainer glands are being considered in lieu of regular glands.

When bell flanges tapped for studs are required, alloy steel stud bolts with the required stud length equal to the length of the Tee head bolt it replaces should normally be specified.

Boltless Fastite, Fast-Grip, Flex-Ring, and Lok-Ring push-on joint pipe and fittings are normally less labor-intensive and labor-reliant than mechanical joints pictured and are often preferred for many applications. See appropriate sections of the Pipe Manual for more information with regard to these joint configurations.



**AMERICAN Ductile Iron Mechanical Joint Pipe
Allowable Joint Deflection**

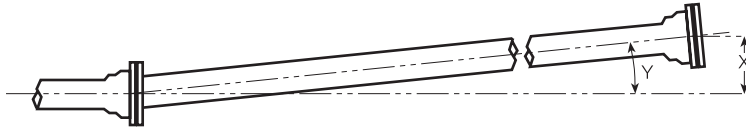

Table No. 3-7

| Size in. | Nominal Laying Length ft. | Maximum Recommended Deflection | |
|-------------|---------------------------------|--------------------------------------|---------------------------------|
| | | X Offset per Nominal Length (in.) | Y Deflection Angle (degrees) |
| 4 | 18 | 31 | 8°-18' |
| 6 | 20 | 30 | 7°-07' |
| 8 | 20 | 22 | 5°-21' |
| 10 | 20 | 22 | 5°-21' |
| 12 | 20 | 22 | 5°-21' |

The joint should be assembled with the pipe in reasonably straight alignment. Joint deflection to the maximum shown above may be made after assembly but before tightening bolts. Offset distances are based on nominal 18- or 20-foot lengths as shown.

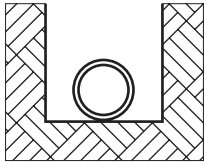
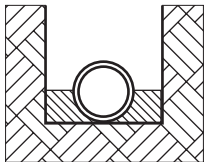
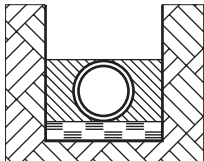
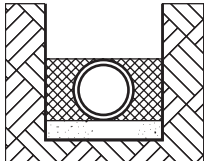
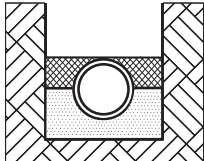

AMERICAN Ductile Iron Pipe
ANSI/AWWA C150/A21.50
and
ANSI/AWWA C151/A21.51
Standard Laying Conditions

| Laying Condition | Description |
|---|--|
|  Type 1* | Flat-bottom trench.† Loose backfill. |
|  Type 2 | Flat-bottom trench.† Backfill lightly consolidated to centerline of pipe. |
|  Type 3 | Pipe bedded in 4" minimum loose soil.†† Backfill lightly consolidated to top of pipe. |
|  Type 4 | Pipe bedded in sand, gravel or crushed stone to depth of 1/8 pipe diameter, 4" minimum. Backfill compacted to top of pipe. (Approximately 80% Standard Proctor, AASHTO T-99.) |
|  Type 5 | Pipe bedded to its centerline in compacted granular§ material, 4" minimum under pipe. Compacted granular or select material†† to top of pipe. (Approximately 90% Standard Proctor, AASHTO T-99.) |

*For 14" and larger pipe, consideration should be given to the use of laying conditions other than Type 1.

† "Flat-bottom" is defined as undisturbed earth.

†† "Loose soil" or "select material" is defined as native soil excavated from the trench, free of rocks, foreign material and frozen earth.

§ Granular materials are defined per the AASHTO Soil Classification System (ASTM D3282) or the Unified Soil Classification System (ASTM D2487), with the exception that gravel bedding/backfill adjacent to the pipe is limited to 2" maximum particle size per ANSI/AWWA C600.

Fig. 3-2



AMERICAN Ductile Iron Pipe
ANSI/AWWA C150/A21.50
and
ANSI/AWWA C151/A21.51
Standard Pressure Classes – Wall Thickness and Nominal Wall Thickness

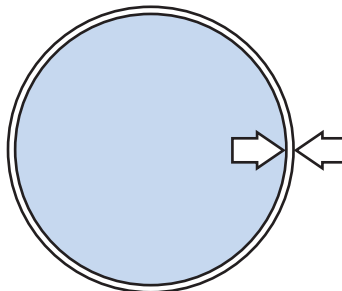

Table No. 3-8

| Size in. | Outside Diameter in. | Pressure Class | | | | |
|-----------------------------|----------------------|----------------|------|------|------|------|
| | | 150 | 200 | 250 | 300 | 350 |
| Nominal Thickness in Inches | | | | | | |
| 4 | 4.80 | – | – | – | – | 0.25 |
| 6 | 6.90 | – | – | – | – | 0.25 |
| 8 | 9.05 | – | – | – | – | 0.25 |
| 10 | 11.10 | – | – | – | – | 0.26 |
| 12 | 13.20 | – | – | – | – | 0.28 |
| 14 | 15.30 | – | – | 0.28 | 0.30 | 0.31 |
| 16 | 17.40 | – | – | 0.30 | 0.32 | 0.34 |
| 18 | 19.50 | – | – | 0.31 | 0.34 | 0.36 |
| 20 | 21.60 | – | – | 0.33 | 0.36 | 0.38 |
| 24 | 25.80 | – | 0.33 | 0.37 | 0.40 | 0.43 |
| 30 | 32.00 | 0.34 | 0.38 | 0.42 | 0.45 | 0.49 |
| 36 | 38.30 | 0.38 | 0.42 | 0.47 | 0.51 | 0.56 |
| 42 | 44.50 | 0.41 | 0.47 | 0.52 | 0.57 | 0.63 |
| 48 | 50.80 | 0.46 | 0.52 | 0.58 | 0.64 | 0.70 |
| 54 | 57.56 | 0.51 | 0.58 | 0.65 | 0.72 | 0.79 |
| 60 | 61.61 | 0.54 | 0.61 | 0.68 | 0.76 | 0.83 |
| 64 | 65.67 | 0.56 | 0.64 | 0.72 | 0.80 | 0.87 |

Pressure classes are defined as the rated water working pressure of the pipe in psi. The thicknesses shown are adequate for the rated water working pressure plus a surge allowance of 100 psi. Calculations result in net thicknesses and are based on a minimum yield strength in tension of 42,000 psi and 2.0 safety factor times the sum of working pressure and 100 psi surge allowance.

Thickness can be calculated for rated water working pressure and surges other than the above by use of equation 1 in ANSI/AWWA C150/A21.50.

AMERICAN Ductile Iron pipe is available for water working pressures greater than 350 psi. Check AMERICAN for details.

These are standard pressure classes as given in AWWA C150 and C151. AMERICAN can furnish any thickness in between these standard thicknesses if deemed economical for major projects.

AMERICAN Ductile Iron pipe is also available with thicknesses greater than Pressure Class 350. For special applications, contact AMERICAN.



**AMERICAN Ductile Iron
Fastite® Joint Pipe
ANSI/AWWA C151/A21.51
Weights for Pressure Classes**

Table No. 3-9

| Size in. | Pressure Class | Wall Thickness in. | Weight in Pounds | | |
|----------|----------------|--------------------|--------------------|--------------------|------------------------|
| | | | Per Foot Plain End | Fastite Joint | |
| | | | | Per Foot inc. Bell | Per 20' Nominal Length |
| 4 | 350 | 0.25 | 10.9 | 11.3 | 226 |
| 6 | 350 | 0.25 | 16.0 | 16.7 | 335 |
| 8 | 350 | 0.25 | 21.1 | 22.1 | 445 |
| 10 | 350 | 0.26 | 27.1 | 28.5 | 575 |
| 12 | 350 | 0.28 | 34.8 | 36.4 | 730 |
| 14 | 250 | 0.28 | 40.4 | 42.4 | 855 |
| | 300 | 0.30 | 43.3 | 45.3 | 915 |
| | 350 | 0.31 | 44.7 | 46.7 | 940 |
| 16 | 250 | 0.30 | 49.3 | 51.5 | 1035 |
| | 300 | 0.32 | 52.5 | 54.8 | 1100 |
| | 350 | 0.34 | 55.8 | 58.0 | 1165 |
| 18 | 250 | 0.31 | 57.2 | 60.8 | 1220 |
| | 300 | 0.34 | 62.6 | 66.2 | 1325 |
| | 350 | 0.36 | 66.2 | 69.8 | 1400 |
| 20 | 250 | 0.33 | 67.5 | 71.5 | 1430 |
| | 300 | 0.36 | 73.5 | 77.5 | 1555 |
| | 350 | 0.38 | 77.5 | 81.5 | 1635 |
| 24 | 200 | 0.33 | 80.8 | 85.6 | 1715 |
| | 250 | 0.37 | 90.5 | 95.3 | 1910 |
| | 300 | 0.40 | 97.7 | 102.5 | 2055 |
| | 350 | 0.43 | 104.9 | 109.7 | 2200 |
| 30 | 150 | 0.34 | 103.5 | 111.7 | 2240 |
| | 200 | 0.38 | 115.5 | 123.7 | 2480 |
| | 250 | 0.42 | 127.5 | 135.7 | 2720 |
| | 300 | 0.45 | 136.5 | 144.7 | 2900 |
| 36 | 150 | 0.38 | 138.5 | 149.2 | 2990 |
| | 200 | 0.42 | 152.9 | 163.6 | 3280 |
| | 250 | 0.47 | 170.9 | 181.6 | 3640 |
| | 300 | 0.51 | 185.3 | 196.0 | 3930 |
| 42 | 150 | 0.56 | 203.2 | 213.9 | 4285 |
| | 200 | 0.41 | 173.8 | 189.6 | 3790 |
| | 250 | 0.47 | 198.9 | 214.7 | 4295 |
| | 300 | 0.52 | 219.9 | 235.6 | 4710 |
| 48 | 300 | 0.57 | 240.7 | 256.5 | 5130 |
| | 350 | 0.63 | 265.7 | 281.4 | 5630 |
| | 150 | 0.46 | 222.6 | 242.1 | 4840 |
| | 200 | 0.52 | 251.3 | 270.8 | 5415 |
| 48 | 250 | 0.58 | 280.0 | 299.5 | 5990 |
| | 300 | 0.64 | 308.6 | 328.1 | 6560 |
| | 350 | 0.70 | 337.1 | 356.6 | 7130 |

Weights for all sizes are for 20-ft nominal lengths.
Dimensions, lengths, weights, etc., are subject to change at our option.



**AMERICAN Ductile Iron
Fastite Joint Pipe
ANSI/AWWA C151/A21.51
Weights for Pressure Classes**

Table No. 3-9—Continued

| Size in. | Pressure Class | Wall Thickness in. | Weight in Pounds | | |
|-------------|-------------------|--------------------------|-----------------------|-----------------------|---------------------------|
| | | | Per Foot Plain End | Fastite Joint | |
| | | | | Per Foot inc. Bell | Per 20' Nominal Length |
| 54 | 150 | 0.51 | 279.7 | 305.5 | 6110 |
| | 200 | 0.58 | 317.7 | 343.5 | 6870 |
| | 250 | 0.65 | 355.6 | 381.4 | 7605 |
| | 300 | 0.72 | 393.4 | 419.2 | 8360 |
| | 350 | 0.79 | 431.1 | 456.9 | 9110 |
| 60 | 150 | 0.54 | 317.0 | 345.5 | 6910 |
| | 200 | 0.61 | 357.7 | 386.2 | 7725 |
| | 250 | 0.68 | 398.3 | 426.8 | 8535 |
| | 300 | 0.76 | 444.6 | 473.0 | 9460 |
| | 350 | 0.83 | 485.0 | 513.4 | 10270 |
| 64 | 150 | 0.56 | 350.5 | 384.4 | 7685 |
| | 200 | 0.64 | 400.1 | 433.9 | 8680 |
| | 250 | 0.72 | 449.6 | 483.4 | 9670 |
| | 300 | 0.80 | 498.9 | 532.7 | 10655 |
| | 350 | 0.87 | 542.0 | 575.8 | 11515 |



60" AMERICAN Fastite® Joint Ductile Iron pipe being installed as a water transmission main.



AMERICAN Ductile Iron Pipe
ANSI/AWWA C151/A21.51
Pressure Ratings and Depths of Cover
Minimum Pressure Classes

In Table No. 3-10 on the following page the relationships of Minimum Pressure Classes, rated working pressure and maximum depths of cover are tabulated. Following in Table No. 3-11 this same information is tabulated for all Pressure Classes. Information in these tables is based on the same conservative design principles as is the information shown in Table No. 14 of AWWA C150 and Table No. 51.3 of AWWA C151. The information included and the intended use of these tables are as follows:

Table No. 3-10—Working Pressure/Maximum Depths of Cover for Minimum Pressure Classes

In Table No. 3-10 are tabulated the corresponding nominal wall thickness, maximum rated working pressure, and maximum depth of cover for the five types of laying conditions, all for Minimum Pressure Classes of ductile iron pipe.

The information in this table is taken from Table No. 3-11 and is offered as a convenience for those wanting to quickly check the capabilities of Minimum Pressure Classes of ductile iron pipe under a given set of conditions. For the majority of internal pressure and external loading conditions, Minimum Pressure Classes are more than adequate and possess substantial true safety factors.

Table No. 3-11—Working Pressure/Maximum Depths of Cover

In Table No. 3-11 are listed the standard Pressure Classes and for each class are tabu-

lated the corresponding nominal wall thickness, maximum rated working pressure, and maximum depths of cover for the five types of laying conditions.

For any specified standard Pressure Class the nominal wall thickness, the maximum rated working pressure, and the maximum depth of cover for each standard laying condition can be determined.

For any water working pressure of 150, 200, 250, 300 or 350 psi, the corresponding standard Pressure Class and nominal wall thickness can be determined. (Note: Although not listed in the following table, ductile iron pipe for working pressures higher than 350 psi is available. Consult AMERICAN regarding specific conditions involved.)

For any required depth of cover from 2.5' up to the maximums shown in this table the Pressure Class and the corresponding nominal wall thickness can be determined for laying conditions Type 1 through Type 5.

For other conditions not covered in these tables see AWWA C150 or consult AMERICAN for design of pipe thickness. Special thickness classes shown in Table No. 3-12 may be appropriate in such cases.



**AMERICAN Ductile Iron Pipe
for Water or Other Liquids
ANSI/AWWA C151/A21.51
WORKING PRESSURES AND MAXIMUM DEPTHS OF COVER
for Minimum Pressure Classes of Ductile Iron Pipe
4" thru 64"**

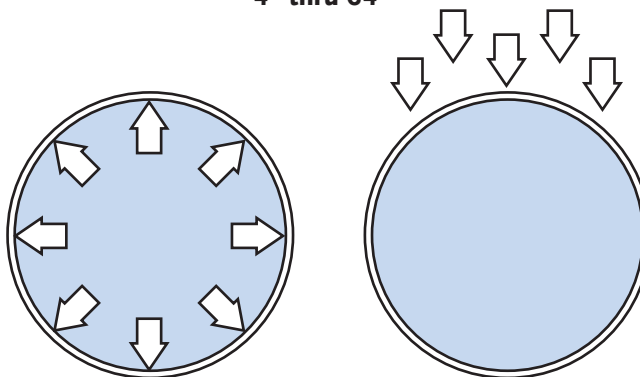

Table No. 3-10

| Size in. | Pressure Class | Thickness in. | Working Pressure† psi | LAYING CONDITIONS Maximum Depth of Cover in Feet†† | | | | |
|----------|----------------|---------------|-----------------------|---|--------|--------|--------|--------|
| | | | | Type 1 | Type 2 | Type 3 | Type 4 | Type 5 |
| 4 | 350 | 0.25 | 350 | 53.0 | 61.0 | 69.0 | 85.0 | 100.0‡ |
| 6 | 350 | 0.25 | 350 | 26.0 | 31.0 | 37.0 | 47.0 | 65.0 |
| 8 | 350 | 0.25 | 350 | 16.0 | 20.0 | 25.0 | 34.0 | 50.0 |
| 10 | 350 | 0.26 | 350 | 11.0** | 15.0 | 19.0 | 28.0 | 45.0 |
| 12 | 350 | 0.28 | 350 | 10.0** | 15.0 | 19.0 | 28.0 | 44.0 |
| 14 | 250 | 0.28 | 250 | * | 11.0** | 15.0 | 23.0 | 36.0 |
| 16 | 250 | 0.30 | 250 | * | 11.0** | 15.0 | 24.0 | 34.0 |
| 18 | 250 | 0.31 | 250 | * | 10.0** | 14.0 | 22.0 | 31.0 |
| 20 | 250 | 0.33 | 250 | * | 10.0 | 14.0 | 22.0 | 30.0 |
| 24 | 200 | 0.33 | 200 | * | 8.0** | 12.0 | 17.0 | 25.0 |
| 30 | 150 | 0.34 | 150 | * | – | 9.0 | 14.0 | 22.0 |
| 36 | 150 | 0.38 | 150 | * | – | 9.0 | 14.0 | 21.0 |
| 42 | 150 | 0.41 | 150 | * | – | 9.0 | 13.0 | 20.0 |
| 48 | 150 | 0.46 | 150 | * | – | 9.0 | 13.0 | 20.0 |
| 54 | 150 | 0.51 | 150 | * | – | 9.0 | 13.0 | 20.0 |
| 60 | 150 | 0.54 | 150 | * | 5.0** | 9.0 | 13.0 | 20.0 |
| 64 | 150 | 0.56 | 150 | * | 5.0** | 9.0 | 13.0 | 20.0 |

†These pipes are adequate for the rated working pressure plus a surge allowance of 100 psi. Ductile iron pipe for working pressures higher than 350 psi is available. Figures include 2.0 safety factor times the sum of working pressure and 100 psi surge allowance.

††An allowance for single H-20 truck with 1.5 impact factor is included for all sizes and all depths of cover.

‡Calculated maximum depth of cover exceeds 100'.

*Laying condition Type 1 is limited to 12" and smaller pipe. For 14" and larger pipe, laying condition Type 1 should not be used.

**Minimum allowable depth of cover is 3'.



**AMERICAN Ductile Iron Pipe
for Water or Other Liquids
ANSI/AWWA C151/A21.51
WORKING PRESSURES AND MAXIMUM DEPTHS OF COVER
for Pressure Classes**

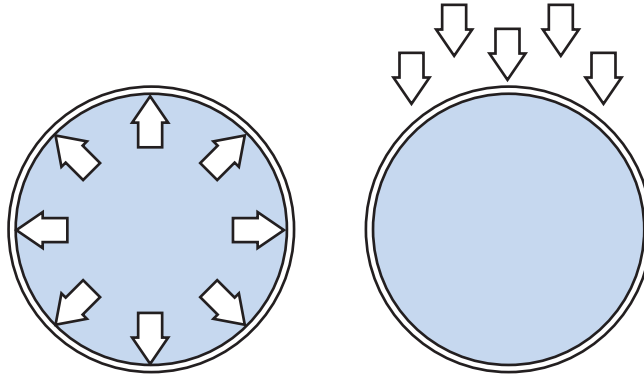

Table No. 3-11

| Size in. | Pressure† Class psi | Nominal Thickness in. | LAYING CONDITIONS Maximum Depth of Cover in Feet†† | | | | |
|----------|---------------------------|-----------------------------|---|--------|--------|--------|--------|
| | | | Type 1 | Type 2 | Type 3 | Type 4 | Type 5 |
| 4 | 350 | 0.25 | 53 | 61 | 69 | 85 | 100* |
| 6 | 350 | 0.25 | 23 | 31 | 37 | 47 | 65 |
| 8 | 350 | 0.25 | 16 | 20 | 25 | 34 | 50 |
| 10 | 350 | 0.26 | 11** | 15 | 19 | 28 | 45 |
| 12 | 350 | 0.28 | 10** | 15 | 19 | 28 | 44 |
| 14 | 250 | 0.28 | †† | 11** | 15 | 23 | 36 |
| | 300 | 0.30 | †† | 13 | 17 | 26 | 42 |
| | 350 | 0.31 | †† | 14 | 19 | 27 | 44 |
| 16 | 250 | 0.31 | †† | 11** | 15 | 24 | 34 |
| | 300 | 0.32 | †† | 13 | 17 | 26 | 39 |
| | 350 | 0.34 | †† | 15 | 20 | 28 | 44 |
| 18 | 250 | 0.31 | †† | 10** | 14 | 22 | 31 |
| | 300 | 0.34 | †† | 13 | 17 | 26 | 36 |
| | 350 | 0.36 | †† | 15 | 19 | 28 | 41 |
| 20 | 250 | 0.33 | †† | 10 | 14 | 22 | 30 |
| | 300 | 0.36 | †† | 13 | 17 | 26 | 35 |
| | 350 | 0.38 | †† | 15 | 19 | 28 | 38 |
| 24 | 200 | 0.33 | †† | 8** | 12 | 17 | 25 |
| | 250 | 0.37 | †† | 11 | 15 | 20 | 29 |
| | 300 | 0.40 | †† | 13 | 17 | 24 | 32 |
| | 350 | 0.43 | †† | 15 | 19 | 28 | 37 |

See notes at end of table.



**AMERICAN Ductile Iron Pipe
for Water or Other Liquids
ANSI/AWWA C151/A21.51
WORKING PRESSURES AND MAXIMUM DEPTHS OF COVER
for Pressure Classes**

Table No. 3-11—Continued

| Size in. | Pressure† Class psi | Nominal Thickness in. | LAYING CONDITIONS Maximum Depth of Cover in Feet‡ | | | | |
|-------------|---------------------------|-----------------------------|--|--------|--------|--------|--------|
| | | | Type 1 | Type 2 | Type 3 | Type 4 | Type 5 |
| 30 | 150 | 0.34 | †† | — | 9 | 14 | 22 |
| | 200 | 0.38 | †† | 8* | 12 | 16 | 24 |
| | 250 | 0.42 | †† | 11 | 15 | 19 | 27 |
| | 300 | 0.45 | †† | 12 | 16 | 21 | 29 |
| | 350 | 0.49 | †† | 15 | 19 | 25 | 33 |
| 36 | 150 | 0.38 | †† | — | 9 | 14 | 21 |
| | 200 | 0.42 | †† | 8* | 12 | 15 | 23 |
| | 250 | 0.47 | †† | 10 | 14 | 18 | 25 |
| | 300 | 0.51 | †† | 12 | 16 | 20 | 28 |
| | 350 | 0.56 | †† | 15 | 19 | 24 | 32 |
| 42 | 150 | 0.41 | †† | — | 9 | 13 | 20 |
| | 200 | 0.47 | †† | 8 | 12 | 15 | 22 |
| | 250 | 0.52 | †† | 10 | 14 | 17 | 25 |
| | 300 | 0.57 | †† | 12 | 16 | 20 | 27 |
| | 350 | 0.63 | †† | 15 | 19 | 23 | 32 |
| 48 | 150 | 0.46 | †† | — | 9 | 13 | 20 |
| | 200 | 0.52 | †† | 8 | 11 | 15 | 22 |
| | 250 | 0.58 | †† | 10 | 13 | 17 | 24 |
| | 300 | 0.64 | †† | 12 | 15 | 19 | 27 |
| | 350 | 0.70 | †† | 15 | 18 | 22 | 30 |
| 54 | 150 | 0.51 | †† | — | 9 | 13 | 20 |
| | 200 | 0.58 | †† | 8 | 11 | 14 | 22 |
| | 250 | 0.65 | †† | 10 | 13 | 16 | 24 |
| | 300 | 0.72 | †† | 13 | 15 | 19 | 27 |
| | 350 | 0.79 | †† | 15 | 18 | 22 | 30 |
| 60 | 150 | 0.54 | †† | 5** | 9 | 13 | 20 |
| | 200 | 0.61 | †† | 8 | 11 | 14 | 22 |
| | 250 | 0.68 | †† | 10 | 13 | 16 | 24 |
| | 300 | 0.76 | †† | 13 | 15 | 19 | 26 |
| | 350 | 0.83 | †† | 15 | 18 | 22 | 30 |
| 64 | 150 | 0.56 | †† | 2** | 9 | 13 | 20 |
| | 200 | 0.64 | †† | 8 | 11 | 14 | 21 |
| | 250 | 0.72 | †† | 10 | 13 | 16 | 24 |
| | 300 | 0.80 | †† | 12 | 15 | 19 | 26 |
| | 350 | 0.87 | †† | 15 | 17 | 21 | 29 |

*Calculated maximum depth of cover exceeds 100'.

†These pipes are adequate for the rated working pressure indicated for each nominal size plus a surge allowance of 100 psi. Calculations are based on a 2.0 safety factor times the sum of working pressure and 100 psi surge allowance. Ductile iron pipe for working pressures higher than 350 psi is available.

‡An allowance for a single H-20 truck with 1.5 impact factor is included for all sizes and all depths of cover.

††Laying condition Type 1 is limited to 12" and smaller pipe. For 14" and larger pipe, laying condition Type 1 should not be used.

**Minimum allowable depth of cover is 3'.



**AMERICAN Ductile Iron Pipe
ANSI/AWWA C150/A21.50
and
ANSI/AWWA C151/A21.51
Nominal Wall Thicknesses for Special Thickness Classes**

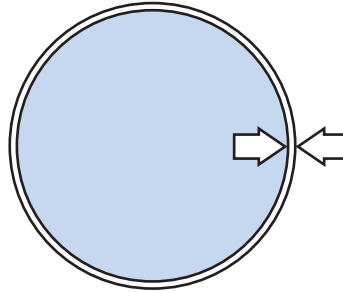

Table No. 3-12

| Size in. | Outside Diameter in. | SPECIAL THICKNESS CLASSES—Wall Thickness in Inches* | | | | | | |
|----------|----------------------|---|-----|-----|-----|-----|-----|------|
| | | 50 | 51 | 52 | 53 | 54 | 55 | 56 |
| 4 | 4.80 | — | .26 | .29 | .32 | .35 | .38 | .41 |
| 6 | 6.90 | .25 | .28 | .31 | .34 | .37 | .40 | .43 |
| 8 | 9.05 | .27 | .30 | .33 | .36 | .39 | .42 | .45 |
| 10 | 11.10 | .29 | .32 | .35 | .38 | .41 | .44 | .47 |
| 12 | 13.20 | .31 | .34 | .37 | .40 | .43 | .46 | .49 |
| 14 | 15.30 | .33 | .36 | .39 | .42 | .45 | .48 | .51 |
| 16 | 17.40 | .34 | .37 | .40 | .43 | .46 | .49 | .52 |
| 18 | 19.50 | .35 | .38 | .41 | .44 | .47 | .50 | .53 |
| 20 | 21.60 | .36 | .39 | .42 | .45 | .48 | .51 | .54 |
| 24 | 25.80 | .38 | .41 | .44 | .47 | .50 | .53 | .56 |
| 30 | 32.00 | .39 | .43 | .47 | .51 | .55 | .59 | .63 |
| 36 | 38.30 | .43 | .48 | .53 | .58 | .63 | .68 | .73 |
| 42 | 44.50 | .47 | .53 | .59 | .65 | .71 | .77 | .83 |
| 48 | 50.80 | .51 | .58 | .65 | .72 | .79 | .86 | .93 |
| 54 | 57.56 | .57 | .65 | .73 | .81 | .89 | .97 | 1.05 |

*These are Special Thickness Classes as shown in AWWA C150 and C151. They were previously designated standard thickness classes. AMERICAN can furnish any thickness in between these Special Thicknesses if deemed economical for major projects.

Special classes are most appropriately used for some threaded, grooved, or ball and socket pipes or for extraordinary design conditions, and they are generally less available than standard pressure class pipe.

For pressure rating and maximum depth of cover capabilities of Special Thickness Classes, check AMERICAN. These capabilities can be estimated by comparing metal thickness and capabilities of those of Pressure Classes in Table No. 3-11, or may be calculated by using the design formulas shown in AWWA C150.



**AMERICAN Ductile Iron Fastite® Joint and Mechanical Joint Pipe
ANSI/AWWA C151/A21.51
Wall Thickness and Weights for Special Thickness Classes**

Table No. 3-13

| Size in. | Thickness Class | Wall Thickness in. | Weight in Pounds | | | | |
|----------|-----------------|--------------------|--------------------|--------------------|--------------------------|--------------------|----------------------|
| | | | Per Foot Plain End | Fastite Joint | | Mechanical Joint* | |
| | | | | Per Foot inc. Bell | Per 20' Nominal** Length | Per Foot inc. Bell | Per Nominal** Length |
| 4 | 51 | .26 | 11.3 | 11.7 | 234 | - | - |
| | 52 | .29 | 12.6 | 12.9 | 259 | - | - |
| | 53 | .32 | 13.8 | 14.1 | 283 | 14.5 | 290 |
| | 54 | .35 | 15.0 | 15.3 | 307 | - | - |
| | 55 | .38 | 16.1 | 16.5 | 331 | - | - |
| | 56 | .41 | 17.3 | 17.6 | 354 | - | - |
| 6 | 50 | .25 | 16.0 | 16.5 | 335 | - | - |
| | 51 | .28 | 17.8 | 18.4 | 370 | - | - |
| | 52 | .31 | 19.6 | 20.2 | 405 | - | - |
| | 53 | .34 | 21.4 | 22.0 | 445 | 22.3 | 450 |
| | 54 | .37 | 23.2 | 23.8 | 480 | - | - |
| | 55 | .40 | 25.0 | 25.5 | 515 | - | - |
| 8 | 50 | .27 | 22.8 | 23.7 | 475 | - | - |
| | 51 | .30 | 25.2 | 26.1 | 525 | - | - |
| | 52 | .33 | 27.7 | 28.6 | 575 | - | - |
| | 53 | .36 | 30.1 | 31.0 | 625 | 31.3 | 630 |
| | 54 | .39 | 32.5 | 33.4 | 670 | - | - |
| | 55 | .42 | 34.8 | 35.8 | 720 | - | - |
| 10 | 50 | .29 | 30.1 | 31.4 | 635 | - | - |
| | 51 | .32 | 33.2 | 34.5 | 695 | - | - |
| | 52 | .35 | 36.2 | 37.5 | 755 | - | - |
| | 53 | .38 | 39.2 | 40.5 | 815 | 40.7 | 820 |
| | 54 | .41 | 42.1 | 43.5 | 875 | - | - |
| | 55 | .44 | 45.1 | 46.5 | 935 | - | - |
| 12 | 50 | .31 | 38.4 | 40.0 | 800 | - | - |
| | 51 | .34 | 42.0 | 43.6 | 875 | - | - |
| | 52 | .37 | 45.6 | 47.2 | 950 | - | - |
| | 53 | .40 | 49.2 | 50.8 | 1020 | 51.1 | 1030 |
| | 54 | .43 | 52.8 | 54.3 | 1090 | - | - |
| | 55 | .46 | 56.3 | 57.9 | 1160 | - | - |
| 14 | 50 | .33 | 47.5 | 49.5 | 990 | - | - |
| | 51 | .36 | 51.7 | 53.7 | 1075 | - | - |
| | 52 | .39 | 55.9 | 57.9 | 1160 | - | - |
| | 53 | .42 | 60.1 | 62.1 | 1245 | - | - |
| | 54 | .45 | 64.2 | 66.2 | 1325 | - | - |
| | 55 | .48 | 68.4 | 70.4 | 1410 | - | - |
| 16 | 50 | .34 | 55.8 | 58.0 | 1160 | - | - |
| | 51 | .37 | 60.6 | 62.8 | 1260 | - | - |
| | 52 | .40 | 65.4 | 67.6 | 1355 | - | - |
| | 53 | .43 | 70.1 | 72.3 | 1450 | - | - |
| | 54 | .46 | 74.9 | 77.1 | 1545 | - | - |
| | 55 | .49 | 79.7 | 81.9 | 1640 | - | - |
| 18 | 50 | .35 | 64.4 | 68.0 | 1365 | - | - |
| | 51 | .38 | 69.8 | 73.4 | 1470 | - | - |
| | 52 | .41 | 75.2 | 78.8 | 1580 | - | - |
| | 53 | .44 | 80.6 | 84.2 | 1690 | - | - |
| | 54 | .47 | 86.0 | 89.6 | 1795 | - | - |
| | 55 | .50 | 91.3 | 95.0 | 1905 | - | - |
| | 56 | .53 | 96.7 | 100.3 | 2010 | - | - |

* Mechanical Joint Pipe is available in 4"-12" diameters and Special Thickness Class 53 only.

** 4" mechanical joint pipes are furnished in 18-ft nominal lengths - weights for all other joints and sizes are for 20-ft nominal lengths.

Note: 60" and 64" sizes are not available in Special Classes.

Note: Dimensions, lengths, weights, etc., are subject to change at our option.



**AMERICAN Ductile Iron Fastite® Joint and Mechanical Joint Pipe
ANSI/AWWA C151/A21.51
Wall Thickness and Weights for Special Thickness Classes**

Table No. 3-13—Continued

| Size in. | Thickness Class | Wall Thickness in. | Weight in Pounds | | | | |
|----------|-----------------|--------------------|--------------------|--------------------|--------------------------|--------------------|----------------------|
| | | | Per Foot Plain End | Fastite Joint | | Mechanical Joint* | |
| | | | | Per Foot inc. Bell | Per 20' Nominal** Length | Per Foot inc. Bell | Per Nominal** Length |
| 20 | 50 | .36 | 73.5 | 77.5 | 1555 | — | — |
| | 51 | .39 | 79.5 | 83.5 | 1675 | — | — |
| | 52 | .42 | 85.5 | 89.5 | 1795 | — | — |
| | 53 | .45 | 91.5 | 95.5 | 1915 | — | — |
| | 54 | .48 | 97.5 | 101.5 | 2035 | — | — |
| | 55 | .51 | 103.4 | 107.5 | 2155 | — | — |
| | 56 | .54 | 109.3 | 113.3 | 2270 | — | — |
| 24 | 50 | .38 | 92.9 | 97.7 | 1960 | — | — |
| | 51 | .41 | 100.1 | 104.9 | 2100 | — | — |
| | 52 | .44 | 107.3 | 112.1 | 2245 | — | — |
| | 53 | .47 | 114.4 | 119.2 | 2390 | — | — |
| | 54 | .50 | 121.6 | 126.4 | 2535 | — | — |
| | 55 | .53 | 128.8 | 133.5 | 2675 | — | — |
| | 56 | .56 | 135.9 | 140.7 | 2820 | — | — |
| 30 | 50 | .39 | 118.5 | 126.7 | 2540 | — | — |
| | 51 | .43 | 130.5 | 138.7 | 2780 | — | — |
| | 52 | .47 | 142.5 | 150.7 | 3020 | — | — |
| | 53 | .51 | 154.4 | 162.6 | 3260 | — | — |
| | 54 | .55 | 166.3 | 174.5 | 3495 | — | — |
| | 55 | .59 | 178.2 | 186.4 | 3735 | — | — |
| | 56 | .63 | 190.0 | 198.2 | 3970 | — | — |
| 36 | 50 | .43 | 156.5 | 167.0 | 3345 | — | — |
| | 51 | .48 | 174.5 | 185.0 | 3705 | — | — |
| | 52 | .53 | 192.4 | 202.9 | 4065 | — | — |
| | 53 | .58 | 210.3 | 220.8 | 4425 | — | — |
| | 54 | .63 | 228.1 | 238.6 | 4780 | — | — |
| | 55 | .68 | 245.9 | 256.4 | 5140 | — | — |
| | 56 | .73 | 263.7 | 274.2 | 5495 | — | — |
| 42 | 50 | .47 | 198.9 | 214.7 | 4295 | — | — |
| | 51 | .53 | 224.0 | 239.8 | 4795 | — | — |
| | 52 | .59 | 249.1 | 264.9 | 5295 | — | — |
| | 53 | .65 | 274.0 | 289.8 | 5795 | — | — |
| | 54 | .71 | 298.9 | 314.7 | 6295 | — | — |
| | 55 | .77 | 323.7 | 339.5 | 6790 | — | — |
| | 56 | .83 | 348.4 | 364.2 | 7285 | — | — |
| 48 | 50 | .51 | 246.6 | 266.1 | 5320 | — | — |
| | 51 | .58 | 280.0 | 299.5 | 5990 | — | — |
| | 52 | .65 | 313.4 | 332.9 | 6655 | — | — |
| | 53 | .72 | 346.6 | 366.1 | 7320 | — | — |
| | 54 | .79 | 379.8 | 399.3 | 7985 | — | — |
| | 55 | .86 | 412.9 | 432.4 | 8645 | — | — |
| | 56 | .93 | 445.9 | 465.4 | 9305 | — | — |
| 54 | 50 | .57 | 312.3 | 338.1 | 6760 | — | — |
| | 51 | .65 | 355.6 | 381.4 | 7625 | — | — |
| | 52 | .73 | 398.8 | 424.6 | 8490 | — | — |
| | 53 | .81 | 441.9 | 467.7 | 9355 | — | — |
| | 54 | .89 | 484.9 | 510.7 | 10215 | — | — |
| | 55 | .97 | 527.7 | 553.5 | 11070 | — | — |
| | 56 | 1.05 | 570.4 | 596.2 | 11925 | — | — |

* Mechanical Joint Pipe is available in 4"-12" diameters and Special Thickness Class 53 only.

** 4" mechanical joint pipes are furnished in 18-ft nominal lengths – weights for all other joints and sizes are for 20-ft nominal lengths.

Note: 60" and 64" sizes are not available in Special Classes.

Note: Dimensions, lengths, weights, etc., are subject to change at our option.



Ductile Iron Pipe for Gravity Flow Service

Due to its high strength and stiffness with the resulting ability to support heavy earth and other type external loads, ductile iron pipe has found wide acceptance in gravity flow service such as sewer lines, outfalls and culvert pipe.

The problems of infiltration, root intrusion, and leakage are eliminated in sewer service with the use of the Fastite joint. The resistance of ductile iron to impact, the convenient pipe lengths, and the ease of assembly represent additional advantages of using ductile iron pipe in sewer service. In addition, ductile iron pipe has an inside diameter greater than nominal pipe size which results in greater flow capacity with potential cost savings. Ductile iron pipe is available for normal domestic sewage service with cement lining. Other linings are available for sewer and special services. See Section 11.

Ductile Iron Culvert Pipe ASTM A716

ASTM A716 is the standard for Ductile Iron Culvert Pipe covering sizes 14" through 64" manufactured per ANSI/AWWA C151/A21.51. AMERICAN Ductile Iron Culvert Pipe is furnished with Fastite or other suitable joints and is coated inside and outside with an asphaltic coating approximately 1 mil thick; or may be cement lined.

Minimum pressure classes are shown in this standard for sizes 14" through 64" for the range of cover from 2 to 41 feet, depending on size, based on Type 5 trench condition. This is the same Type 5 laying condition shown in current AWWA Stan-

dards C150 and C151. See Fig. 3-2. Pipe thickness for other conditions can be calculated by using formulas and design criteria in AWWA C150, except with modifications as specified in A716.

Ductile Iron Gravity Sewer Pipe ASTM A746

ASTM A746 is the standard for Ductile Iron Gravity Sewer Pipe in sizes 4" through 64" with Fastite Joints.

The design of AMERICAN Ductile Iron Gravity Sewer Pipe in this standard is based on the same formulas and design criteria as pipe designed per ANSI/AWWA C150/A21.50, except that pipe with a flexible lining is designed with maximum allowable deflection of 5% of the outside diameter of the pipe instead of 3%. In the A746 Standard are thickness tables for **Cement-lined** pipe and for **Flexible-lined** pipe.

The thicknesses for **Cement-lined** pipe will be the same as those in AWWA C151 for the same depths of cover and laying conditions. See Table No. 3-11.

Table No. 3-14 shows depths of cover for the different laying conditions for 4" through 64" Pressure Classes of **Flexible-lined** pipe. The shaded areas indicate the depths of cover which are different from **Cement-lined** pipe per A746 and from AWWA C151 as shown in Table No. 3-11. These depths of cover are controlled by design deflection (instead of ring bending stress) and are greater than those for **Cement-lined** pipe due to the 5% design deflection.



**AMERICAN Ductile Iron Fastite® Joint
Gravity Sewer Pipe
ASTM A746
PIPE WITH FLEXIBLE LININGS
Depths of Cover
for Standard Pressure Classes**

Table No. 3-14

| Size in. | Pressure Class | Thickness in. | LAYING CONDITIONS Maximum Depth of Cover in Feet | | | | |
|----------|----------------|---------------|---|--------|--------|--------|--------|
| | | | Type 1 | Type 2 | Type 3 | Type 4 | Type 5 |
| 4 | 350 | 0.25 | 53 | 61 | 69 | 85 | 109 |
| 6 | 350 | 0.25 | 26 | 31 | 37 | 47 | 65 |
| 18 | 350 | 0.25 | 16 | 20 | 25 | 34 | 50 |
| 10 | 350 | 0.26 | 11* | 15 | 19 | 28 | 45 |
| 12 | 350 | 0.28 | 10* | 15 | 19 | 28 | 44 |
| 14 | 250 | 0.28 | – | 11* | 15 | 23 | 41 |
| | 300 | 0.30 | – | 13 | 17 | 26 | 43 |
| | 350 | 0.31 | – | 14 | 19 | 27 | 44 |
| 16 | 250 | 0.30 | – | 11* | 15 | 24 | 41 |
| | 300 | 0.32 | – | 13 | 17 | 26 | 43 |
| | 350 | 0.34 | – | 15 | 20 | 28 | 45 |
| 18 | 250 | 0.31 | – | 10* | 14 | 23 | 40 |
| | 300 | 0.34 | – | 13 | 17 | 26 | 43 |
| | 350 | 0.36 | – | 15 | 19 | 28 | 45 |
| 20 | 250 | 0.33 | – | 10* | 14 | 23 | 40 |
| | 300 | 0.36 | – | 13 | 17 | 26 | 43 |
| | 350 | 0.38 | – | 15 | 19 | 28 | 44 |
| 24 | 200 | 0.33 | – | 8* | 12 | 20 | 37 |
| | 250 | 0.37 | – | 11 | 15 | 23 | 41 |
| | 300 | 0.40 | – | 13 | 17 | 26 | 43 |
| | 350 | 0.43 | – | 15 | 19 | 28 | 45 |
| 30 | 150 | 0.34 | – | – | 9* | 17 | 33 |
| | 200 | 0.38 | – | 8* | 12 | 20 | 37 |
| | 250 | 0.42 | – | 11 | 15 | 23 | 40 |
| | 300 | 0.45 | – | 12 | 16 | 25 | 42 |
| | 350 | 0.49 | – | 15 | 19 | 28 | 44 |
| 36 | 150 | 0.38 | – | – | 9 | 17 | 33 |
| | 200 | 0.42 | – | 8* | 12 | 20 | 37 |
| | 250 | 0.47 | – | 10 | 14 | 23 | 40 |
| | 300 | 0.51 | – | 12 | 17 | 25 | 42 |
| | 350 | 0.56 | – | 15 | 19 | 28 | 45 |

See notes at end of Table.



**AMERICAN Ductile Iron Fastite® Joint
Gravity Sewer Pipe
ASTM A746
PIPE WITH FLEXIBLE LININGS
Depths of Cover
for Standard Pressure Classes**

Table No. 3-14—Continued

| Size in. | Pressure Class | Thickness in. | LAYING CONDITIONS Maximum Depth of Cover in Feet | | | | |
|-------------|-------------------|------------------|---|--------|--------|--------|--------|
| | | | Type 1 | Type 2 | Type 3 | Type 4 | Type 5 |
| 42 | 150 | 0.41 | – | – | 9 | 16 | 32 |
| | 200 | 0.47 | – | 8 | 12 | 20 | 37 |
| | 250 | 0.52 | – | 10 | 14 | 23 | 40 |
| | 300 | 0.57 | – | 12 | 17 | 25 | 42 |
| | 350 | 0.63 | – | 15 | 19 | 28 | 45 |
| 48 | 150 | 0.46 | – | – | 9 | 17 | 33 |
| | 200 | 0.52 | – | 8 | 12 | 20 | 37 |
| | 250 | 0.58 | – | 10 | 14 | 23 | 40 |
| | 300 | 0.64 | – | 12 | 17 | 25 | 42 |
| | 350 | 0.70 | – | 15 | 19 | 28 | 44 |
| 54 | 150 | 0.51 | – | – | 9 | 17 | 33 |
| | 200 | 0.58 | – | 8 | 12 | 20 | 37 |
| | 250 | 0.65 | – | 10 | 14 | 23 | 40 |
| | 300 | 0.72 | – | 13 | 17 | 25 | 43 |
| | 350 | 0.79 | – | 15 | 19 | 28 | 45 |
| 60 | 150 | 0.54 | – | 5* | 9 | 17 | 33 |
| | 200 | 0.61 | – | 8 | 12 | 20 | 37 |
| | 250 | 0.68 | – | 10 | 14 | 23 | 40 |
| | 300 | 0.76 | – | 13 | 17 | 25 | 43 |
| | 350 | 0.83 | – | 15 | 19 | 28 | 45 |
| 64 | 150 | 0.56 | – | 5* | 9 | 17 | 33 |
| | 200 | 0.64 | – | 8 | 12 | 20 | 36 |
| | 250 | 0.72 | – | 10 | 15 | 23 | 40 |
| | 300 | 0.80 | – | 13 | 17 | 25 | 43 |
| | 350 | 0.87 | – | 15 | 19 | 28 | 45 |

*Minimum allowable depth of cover is 3'.

The shaded areas denote the depths of cover resulting from the pipe thickness being governed by deflection in the design; these covers are greater due to the design deflection of 5% for flexible-lined pipe instead of 3% for cement-lined pipe.



AMERICAN Ductile Iron Pipe Tapping and Cutting

TAPPING* DUCTILE IRON PIPE

AMERICAN Ductile Iron pipe is readily tapped either dry or under pressure by using conventional tapping equipment utilized by most contractors and water utilities.

Taps made directly into the pipe result in clean, sharp, strong threads, making tapping saddles unnecessary for small diameter taps.

Teflon tape or a commercial thread compound which is suitable to the service is recommended to be used on threads.

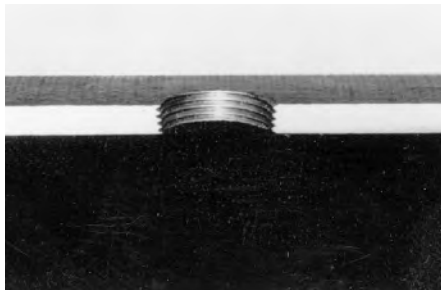

Above is shown a 6" AMERICAN Ductile Iron pipe that has been tapped for a 1" corporation stop, showing the excellent threading properties of ductile iron pipe.

CUTTING* DUCTILE IRON PIPE

AMERICAN Ductile Iron pipe is easily cut in the field by several methods, the most common being as follows:

Abrasive Wheel

A rotary-type abrasive wheel saw is probably one of the most popular tools used for cutting ductile iron pipe. This equipment

is commercially available with gasoline engines as well as pneumatic motors. Cutting time is usually no more than one minute per inch of pipe diameter with most commonly used thicknesses.



Cutting ductile iron pipe with abrasive wheel.

Torch Cutting

Ductile iron pipe can be cut in the field or shop by using an oxyacetylene torch. Best results are obtained by using a No. 8 or No. 10 tip with approximately 75 psi oxygen and 10 to 15 psi acetylene. For cement-lined ductile pipe, the best results are normally obtained when the torch head is inclined approximately 60 degrees to the direction of cutting. See Fig. 3-3.



Cutting ductile iron pipe with torch.

Metallurgical studies have shown that the heat-affected zone in pipe cut by this method exists within only 1/4-inch from the cut face. The hardening of the metal in the 1/4-inch affected heat zone causes some difficulty in threading or machining in the particular portion of the pipe, but such

*Caution should be employed when cutting or tapping pipe when any potentially hazardous condition might exist.



hardening does not interfere with push-on or mechanical joint assembly or performance. Cutting speed for pipe cut by oxyacetylene methods is approximately one minute per inch of diameter for

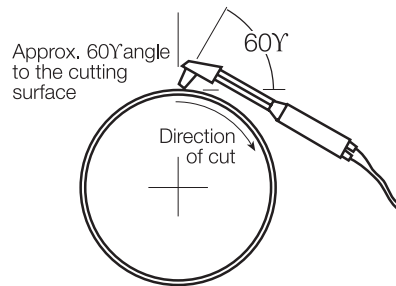

Torch cutting ductile iron pipe
Fig. 3-3

cement-lined pipe and even less for unlined pipe.

Milling Cutter

Several types of milling pipe cutters are available which operate hydraulically, pneumatically or electrically, or are self-powered by a gasoline engine.

The milling-type cutter will normally cut pipe from 6" - 64" diameter. This type of cutter is usually supplied with an air motor which also makes submarine cuts possible. The set-up time for this cutter is usually less than ten minutes; it requires a minimum clearance of 12" and has a cutting speed of approximately one minute per inch of pipe diameter.



Cutting ductile iron pipe with milling cutter.

Other Cutting Methods

Portable guillotine saws are available for cutting pipe from 3" - 18" diameter.

Caution: Hydraulic squeeze cutters are not suitable for cutting ductile iron pipe.

Field Gauging/Rounding

AWWA C151 requires the factory-gauging of the spigot ends of ductile iron pipe. Accordingly, pipe selected for cutting in the field should be fieldgauged.

A circumferential "π" tape can be used for this. Also, a mechanical joint gland inserted over the barrel of the pipe might serve as a convenient indicator for field cutting. Some pipe, especially in the largest diameters, may be out-of-round to the degree that they will need to be rounded by jacking or other methods to facilitate making the joint. This is a normal occurrence and does not in any way affect the serviceability of ductile iron pipe. Instructions for the rounding operation can be obtained from AMERICAN if desired.

Preparation of Field-Cut Joints

Field cuts that will be assembled with mechanical joints will require little or no preparation other than cleaning. When a torch cut is made, the last few inches of the plain end need to be cleaned of any oxides, slag or other protrusions.

When the cut end is to be assembled in a Fastite® bell, an adequately smooth (without sharp edges) bevel should be ground or filed on the cut edge to prevent damage to or dislodgement of the gasket during assembly. See Fig. 3-4. If desired, a thin field "Assembly Line" can be drawn in marker or with paint, with the line located from the spigot end the same distance as the far edge of factory applied assembly stripe.

Note: Generous bevels are advantageous in the assembly of field-prepared ends. To confirm the effectiveness of pipe end preparation and the subsequent assembly of a field-prepared end, a thin "automotive" or other feeler gauge can be effectively used to check (probe) for proper and uniform gasket positioning all around the assembled joints.

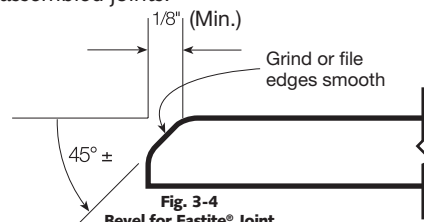

Fig. 3-4
Bevel for Fastite® Joint

*Caution should be employed when cutting or tapping pipe when any potentially hazardous condition might exist.



AMERICAN Ductile Iron Pipe Outlets



Welded-on outlets for flanged, mechanical joint, Fastite and restrained joint connections are furnished for optimum design, installation and economy. See Section 7.



Outlet/Tapping Saddles provide an effective, field adaptable, and economical means of making connection to a pipeline, either during construction or while under pressure. Saddles are available with flanged or mechanical joint outlet for use on pipe sizes 16" through 54". See Section 7.



AMERICAN Ductile Iron Pipe Stacking

It is recommended that pipe to be stored for any extended period of time should not be stacked higher than indicated in the table below. To prevent dirt and debris from entering the pipe, bottom tiers should be kept off the ground on timbers, rails, or concrete supports.

Pipe on succeeding tiers should be alternated — bell-plain end, plain end-bell, etc. Timbers 4" X 4" size should be placed between each tier and chocks nailed at each end to prevent movement of the pipe. For safety and convenience, each size should be stacked separately.

Suggested Maximum Allowable Stacking Heights

Table No. 3-15

| Pipe Size in. | Number of Tiers | Pipe Size in. | Number of Tiers |
|---------------|-----------------|---------------|-----------------|
| 4 | *16 | 24 | 5 |
| 6 | *13 | 30 | 4 |
| 8 | *11 | 36 | 4 |
| 10 | *10 | 42 | 3 |
| 12 | *9 | 48 | 3 |
| 14 | *8 | 54 | 3 |
| 16 | 7 | 60 | 2 |
| 18 | 6 | 64 | 2 |
| 20 | 6 | — | — |

***Stacking heights are limited by practical consideration to a height of approximately 12 feet for purposes of safety and handling ease.**

Loading

Ductile iron pipe is normally shipped in truckload or carload lots for freight economies. Tabulated below are practical loading quantities for minimum classes, Fastite Joint ductile iron cement-lined pipe. Truckload quantities are based on standard 40,000-lb loading.

Quantities can vary due to changes in joints, classes, ICC tariff, linings, weights, dunnage, other material or sizes included in loads, etc. Therefore, this table should be used as a guide only. Check AMERICAN if more exact information is required.

Approximate Loading Quantities Minimum Pressure Classes of Fastite Joint Ductile Iron Pipe

Table No. 3-15

| Pipe Size in. | No. of Nominal Lengths | | Pipe Size in. | No. of Nominal Lengths | |
|---------------|------------------------|---------|---------------|------------------------|---------|
| | Truckload | Carload | | Truckload | Carload |
| 4 | 170 | 459 | 24 | 18 | 27 |
| 6 | 108 | 288 | 30 | 12 | 27 |
| 8 | 81 | 216 | 36 | 8 | 12 |
| 10 | 63 | 126 | 42 | 8 | 12 |
| 12 | 48 | 108 | 48 | 4 | 12 |
| 14 | 40 | 75 | 54 | 4 | 12 |
| 16 | 35 | 60 | 60 | 2 | 12 |
| 18 | 32 | 48 | 64 | 2 | 12 |
| 20 | 24 | 48 | — | — | — |



Other AMERICAN Joints

AMERICAN Fastite® Joint with Fast-Grip® Gasket, 4"-30"

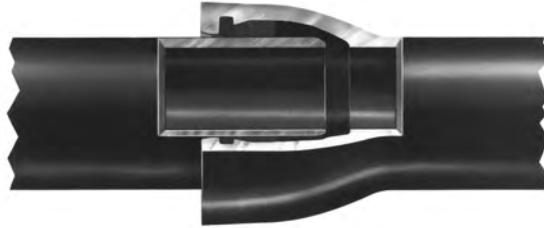

The AMERICAN Fast-Grip Gasket furnished in sizes 4"-30" provides flexible, field-adaptable joint restraint in a standard AMERICAN Fastite (or Flex-Ring) Bell. See Sections 4 and 9.

AMERICAN Flex-Ring® Joint, 4"-12"



The AMERICAN Flex-Ring Joint provides flexible joint restraint against thrust due to internal water working pressure or external forces. It is also used in horizontal directional drilling (HDD) and pipe bursting applications. See Sections 4 and 9.

AMERICAN Flex-Ring® Joint, 14"-48"

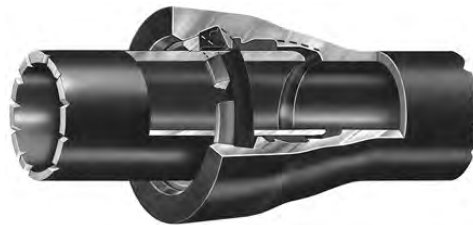

The AMERICAN Flex-Ring Joint provides flexible joint restraint against thrust due to internal water working pressure or external forces. See Section 9.



AMERICAN Joints for Pipe and Fittings

AMERICAN Field Flex-Ring®, 14"-36"

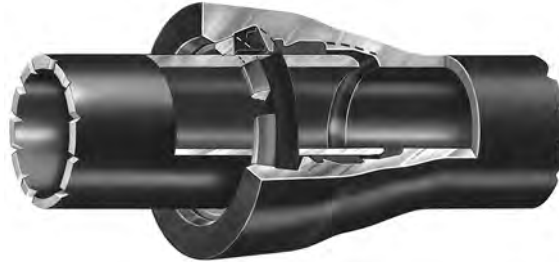

The AMERICAN Field Flex-Ring provides dependable field-adaptable restraint against thrust due to external forces or internal water working pressure up to 350 psi for 14"-24" sizes and up to 250 psi for the 30"-36" sizes in the standard Flex-Ring Joint.

See Section 9.

AMERICAN Lok-Ring® Joint, 54"-64"



The AMERICAN Lok-Ring Joint is furnished in sizes 54" through 64" and provides flexible joint restraint against thrust due to internal water working pressure up to 250 psi.

See Section 9.

AMERICAN MJ Coupled Joint, 4"-48"

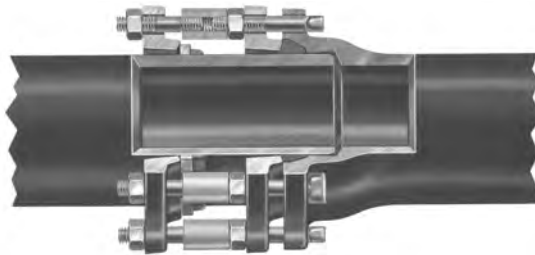

The AMERICAN MJ Coupled Joint is furnished in sizes 4" through 48" and is an adaptation of the standard Mechanical Joint to provide joint restraint against thrust due to internal pressure up to 350 psi through 12" and 250 psi for 14"-48" sizes.

See Section 9.



AMERICAN Joints for Pipe and Fittings

AMERICAN Flex-Lok® Joint, 4"-24"

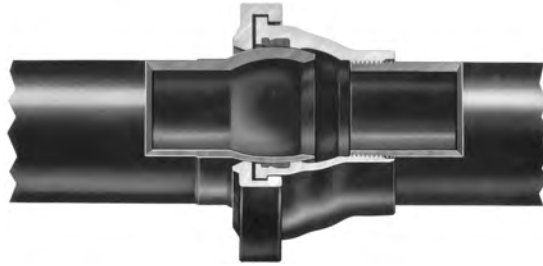

The AMERICAN Flex-Lok Joint, furnished in sizes 4" through 24", is a super-service, boltless flexible joint. This joint is designed to provide up to 15° joint deflection for subaqueous or other difficult installations potentially subject to substantial joint deflections or movements.

See Section 10.

AMERICAN Flex-Lok® Joint, 30"-60"*



The AMERICAN Flex-Lok Joint, furnished in sizes 30" through 60"* , is a superservice, boltless flexible joint. This joint is designed to provide up to 15° joint deflection for subaqueous or other difficult installations potentially subject to substantial joint deflections or movements. *See page 10-2 and check AMERICAN 64" requirements.

See Section 10.

AMERICAN Flanged Joint, 4"-64"



The AMERICAN Flanged Joint, furnished in sizes 4" through 64" , is a rigid joint widely used for exposed plant piping. In combination with other joints and AMERICAN's Toruseal® gasket, it is also commonly used for Long Span service.

See Sections 6, 7 and 8.



AMERICAN Joints for Pipe and Fittings

AMERICAN Grooved and Shouldered Joint, 4"-64"

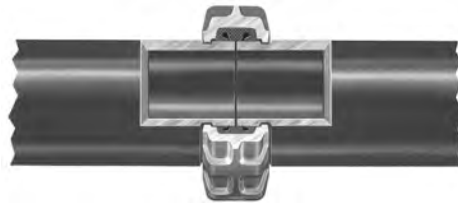

The AMERICAN Grooved Joint pictured above—and to a limited extent the Shouldered Joint (not pictured)—are furnished in sizes 4"-64" for some plant piping installations. See Section 2.

AMERICAN Fastite® Joint Push-Bar® Pipe, 4"-64"

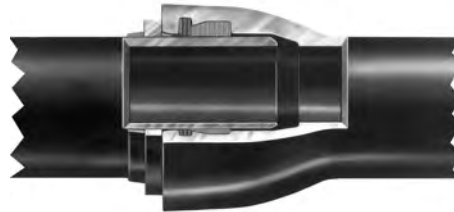

AMERICAN Fastite Joint Push-Bar pipe, furnished in sizes 4"-64", allows the AMERICAN Fastite Joint to be used in trenchless installation using direct jacking or pushing (including high load installations such as microtunneling and some pipe bursting applications). See Section 7



AMERICAN

DUCTILE IRON PIPE

THE RIGHT WAY

Section 4

AMERICAN Ductile Iron Flex-Ring[®] and Lok-Ring[®] Fittings





AMERICAN Ductile Iron Flex-Ring® and Lok-Ring® Fittings

The principal standards covering fittings are ANSI/AWWA C110/A21.10 and ANSI/AWWA C153/A21.53. The principal standard covering joints is ANSI/AWWA C111/A21.11. These and other standards are referenced throughout this section by the full ANSI/AWWA designation or by only the AWWA numbering, such as AWWA C110 or C153.

AMERICAN furnishes a line of 4"–48" Flex-Ring and 54"–64" Lok-Ring fittings meeting the applicable requirements of AWWA C153. These fittings employ the standard Fastite or Fast-Grip gasket seal, and the joints meet the applicable requirements of AWWA C111. Many of these fittings are not specifically listed in the AWWA standards because of joints, outlets, or other variations and are designated as "AMERICAN standard."

When welded joint restraint is desired, Flex-Ring or Lok-Ring fittings should also be used, depending on size. These joints are also essentially boltless and use the standard Fastite gasket for joint sealing. In addition, field adaptable joint restraint is available for 14"–36" Flex-Ring pipe or Flex-Ring fittings by use of AMERICAN's Fast-Grip gaskets or Field Flex-Rings, respectively. See Section 9 for more information on Restrained Joints.

Flex-Ring and Lok-Ring fittings are normally furnished complete with standard Fastite plain rubber gaskets and a sufficient supply of Fastite joint lubricant. Restraining elements for Flex-Ring or Lok-Ring fittings may be shipped either with the fittings or joining pipe, dependent on joint type, fitting configuration, etc. See Section 9.

Flex-Ring and Lok-Ring fittings are furnished of ductile iron only. Fittings for pressure ratings of 250 and 350 psi are furnished as shown in the tables in this Section. Fittings for pressure ratings higher than shown are available for special applications.

Fittings are normally furnished with cement lining in accordance with AWWA C104 and with an outside asphaltic coating. They can also be furnished asphaltic coated or uncoated inside. For special conditions, other types of coatings and linings may be available. See Section 11.



AMERICAN Ductile Iron Flex-Ring® and Lok-Ring® Fittings

General Notes Relating to Flex-Ring and Lok-Ring Fittings

1. Fittings in the following tables with the heading "ANSI/AWWA C153/A21.53" are essentially as specified in that standard. Fittings in tables with the heading "AMERICAN Standard" are either not included in the ANSI/AWWA standard or vary therefrom in weights, dimensions, and/or joints.

2. Fittings are manufactured of ductile iron qualified as per grade 70-50-05 (minimum tensile strength: 70,000 psi; minimum yield strength: 50,000 psi; minimum elongation: 5%) as specified in AWWA C153.

3. Weights of accessories are not included in weights of fittings shown in tables unless specifically noted. For weights of accessories, see Section 2 or Section 9.

4. For allowable joint deflection of Flex-Ring and Lok-Ring fitting joints, see Table 4-3.

5. All pressure ratings are for water service.

6. Some fittings are available with body metal thickness and weights other than shown in the tables. Some fittings are available in different sizes and with different size combinations than shown. All sizes and body metal thicknesses listed may not be available due to equipment changes. Check AMERICAN regarding special requirements.

7. See Section 7 for AMERICAN Specials.

8. Fittings may be furnished by AMERICAN that are manufactured by others. Any such fittings will normally be manufactured in accordance with appropriate ANSI/AWWA standards.

9. The 250 psi rating for 54"–64" fittings is an AMERICAN standard, based on

performance testing. 54"–64" fittings are rated only 150 psi in AWWA C153, although that standard provides for higher pressure ratings by the manufacturer (AMERICAN).

10. Center-to-socket dimensions, wall thicknesses, and weights may vary from those shown in the following tables depending on foundry practice.

11. The locations of taps, bases, or other special options when available on fittings shall be specified by the Purchaser as shown on page 6-5 for similar body type fittings. Likewise, end types and end sizes used in descriptions must be specified in numbering sequence shown on pages 6-5 and 6-6 and the illustrations in this section.

12. Lateral or wye branch fittings with Flex-Ring and Lok-Ring end connections are not shown in this section. For small-diameter varied angle lateral and tangential connections to larger mains, shop-welded outlet pipes are normally preferable and can be furnished with all joining connections as noted in Section 7. For larger or full-opening requirements, some 45° lateral and true wye configurations can also be furnished with these push-on end connections. (Contact AMERICAN for availability.) These wye fittings are special, and for economy and availability, alternative combinations of other standard fittings may be preferable in some cases. (See alternatives as depicted in Sections 5 and 6, etc.)

13. AMERICAN Flex-Ring fittings will work as push-on unrestrained fittings as long as suitable external restraint (thrust blocks, etc.) is applied. Flex-Ring fittings are thus furnished as "Fastite" fittings in many sizes and configurations, at Foundry option.



AMERICAN Ductile Iron Flex-Ring® and Lok-Ring® Fittings
ANSI/AWWA C153/A21.53 and AMERICAN Standard

Flex-Ring and Lok-Ring Fittings Joint Dimensions

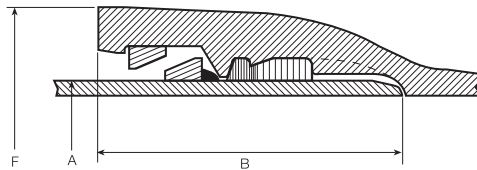

4"-12" Flex-Ring

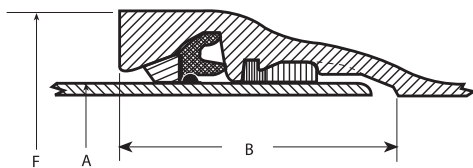

16"-48" Flex-Ring

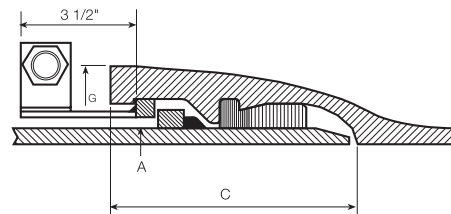

54"-64" Lok-Ring

Table No. 4-1

| Size in. | Dimensions in Inches | | | | |
|-------------|--------------------------|-----------------------------------|----------------------------------|---------------------------------|--------------------------------|
| | A Outside Diameter | B Socket Depth Flex-Ring | C Socket Depth Lok-Ring | F* Bell O.D. Flex-Ring | G* Bell O.D. Lok-Ring |
| 4 | 4.80 | 5.71 | — | 7.18 | — |
| 6 | 6.90 | 5.71 | — | 9.20 | — |
| 8 | 9.05 | 5.83 | — | 11.35 | — |
| 10 | 11.10 | 6.74 | — | 13.75 | — |
| 12 | 13.20 | 6.74 | — | 16.37 | — |
| 16 | 17.40 | 7.38 | — | 21.49 | — |
| 18 | 19.50 | 8.20 | — | 23.71 | — |
| 20 | 21.60 | 8.20 | — | 25.83 | — |
| 24 | 25.80 | 8.96 | — | 30.70 | — |
| 30 | 32.00 | 9.63 | — | 37.04 | — |
| 36 | 38.30 | 9.63 | — | 43.54 | — |
| 42 | 44.50 | 10.84 | — | 50.62 | — |
| 48 | 50.80 | 12.37 | — | 56.98 | — |
| 54 | 57.56 | — | 10.07 | — | 62.14 |
| 60 | 61.61 | — | 10.57 | — | 66.27 |
| 64 | 65.67 | — | 10.57 | — | 70.45 |

*Dimensions subject to change at our option.
 For Fastite pipe dimensions, see Section 2.
 For Flex-Ring and Lok-Ring pipe dimensions, see Section 9.



AMERICAN Ductile Iron Flex-Ring® and Lok-Ring® Fittings
ANSI/AWWA C153/A21.53 and AMERICAN Standard

Flex-Ring End and Lok-Ring End

Standard Dimensions

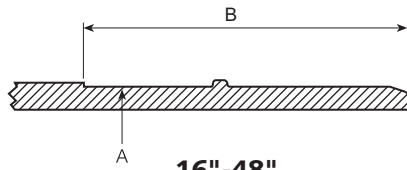

**16"-48"
Flex-Ring End**

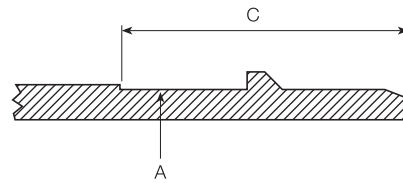

54"-64" Lok-Ring End

Table No. 4-2

| Size in. | A Outside Diameter in. | B Flex-Ring Minimum Gauge Length in. | C Lok-Ring Minimum Gauge Length in. |
|-------------|---------------------------------|--|---|
| 16 | 17.4 | 9 | - |
| 18 | 19.5 | 9 | - |
| 20 | 21.6 | 9 | - |
| 24 | 25.8 | 10 | - |
| 30 | 32.0 | 10 | - |
| 36 | 38.3 | 10 | - |
| 42 | 44.5 | 11 1/2 | - |
| 48 | 50.8 | 13 | - |
| 54 | 57.56 | - | 12 |
| 60 | 61.61 | - | 13 |
| 64 | 65.67 | - | 13 |



Maximum Allowable Separation Push-On Fitting Joints

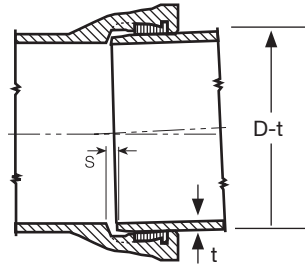

Maximum allowable separation, "S", in a push-on fitting joint is approximately equal to the median pipe diameter in inches times the sine of the deflection angle. This is provided for information only and should not be used to determine precise joint deflection.

Allowable Deflection Push-On Fitting Joints

Table No. 4-3

| Size in. | Flex-Ring | Lok-Ring |
|-------------|----------------------------|----------------------------|
| | Deflection Angle (Deg.) | Deflection Angle (Deg.) |
| 4 | 5 | — |
| 6 | 5 | — |
| 8 | 5 | — |
| 10 | 5 | — |
| 12 | 5 | — |
| 16 | 3.75 | — |
| 18 | 3.75 | — |
| 20 | 3.50 | — |
| 24 | 3.00 | — |
| 30 | 2.50 | — |
| 36 | 2.00 | — |
| 42 | 2.00 | — |
| 48 | 1.50 | — |
| 54 | — | 0.5 |
| 60 | — | 0.5 |
| 64 | — | 0.5 |



AMERICAN Ductile Iron Flex-Ring® and Lok-Ring® Fittings
ANSI/AWWA C153/A21.53* and AMERICAN Standard
90° Bends (1/4th)

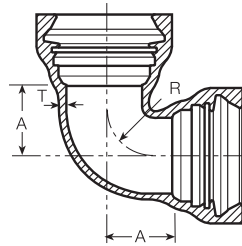

Flex-Ring Bell-Bell**

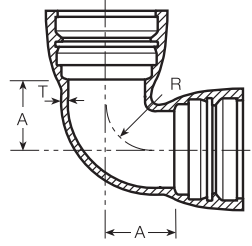

Lok-Ring Bell-Bell**

Table No. 4-4

| Size in. | Pressure† Rating psi | Dimensions in Inches | | | Weight in Pounds | |
|----------|----------------------|----------------------|-------|-------|------------------|----------|
| | | T | A | R | Flex-Ring | Lok-Ring |
| 4 | 350 | 0.34 | 4.00 | 3.00 | 46 | – |
| 6 | 350 | 0.36 | 5.00 | 4.00 | 64 | – |
| 8 | 350 | 0.38 | 6.50 | 5.38 | 91 | – |
| 10 | 350 | 0.40 | 7.50 | 6.25 | 143 | – |
| 12 | 350 | 0.42 | 9.00 | 7.50 | 232 | – |
| 16 | 350 | 0.50†† | 15.00 | 12.50 | 515 | – |
| 18 | 350 | 0.75 | 16.50 | 14.00 | 720 | – |
| 20 | 350 | 0.80 | 18.00 | 15.50 | 815 | – |
| 24 | 350 | 0.61 | 17.00 | 15.50 | 760 | – |
| 30 | 250 | 0.66 | 22.75 | 20.50 | 1290 | – |
| 36 | 250 | 0.74 | 25.75 | 23.50 | 1810 | – |
| 42 | 250 | 0.82 | 29.25 | 26.50 | 2784 | – |
| 48 | 250 | 0.90 | 33.25 | 30.50 | 3960 | – |
| 54 | 250 | 0.90 | 37.00 | 34.25 | – | 3930 |
| 60 | 250 | 0.94 | 39.50 | 36.50 | – | 4620 |
| 64 | 250 | 0.99 | 42.00 | 38.75 | – | 5385 |

*AWWA C153 configurations with shorter center-to-socket dimensions, etc. may be furnished in some cases in the 18"–20" size range. **Contact AMERICAN** if dimensions are critical.

**30" and larger Flex-Ring and Lok-Ring 90° Bends may be furnished with Flex-Ring Ends or Lok-Ring Ends. See Table No. 4-2.

† Higher pressure ratings are available on special applications. Pressure ratings may be limited below the values shown by the pressure rating of the pipe to which fitting is attached, or the restrained joint used.

Based on performance testing per AWWA C153, AMERICAN can rate 30"–48" C153 bends 350 psi. Contact AMERICAN.

See General Notes on page 4-2.

†† 16" Flex-Ring fittings may have greater "T" dimensions than those shown.



AMERICAN Ductile Iron Flex-Ring® and Lok-Ring® Fittings
ANSI/AWWA C153/A21.53* and AMERICAN Standard
45° Bends (1/8th)

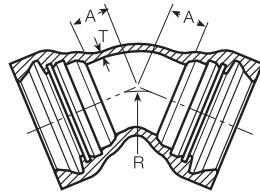

Flex-Ring Bell-Bell**

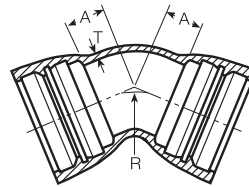

Lok-Ring Bell-Bell**

Table No. 4-5

| Size in. | Pressure† Rating psi | Dimensions in Inches | | | Weight in Pounds | |
|----------|----------------------|----------------------|-------|-------|------------------|----------|
| | | T | A | R | Flex-Ring | Lok-Ring |
| 4 | 350 | 0.34 | 2.00 | 2.41 | 43 | — |
| 6 | 350 | 0.36 | 3.00 | 4.83 | 60 | — |
| 8 | 350 | 0.38 | 3.50 | 5.75 | 80 | — |
| 10 | 350 | 0.40 | 4.50 | 7.85 | 130 | — |
| 12 | 350 | 0.42 | 5.50 | 9.66 | 213 | — |
| 16 | 350 | 0.50†† | 8.00 | 13.25 | 425 | — |
| 18 | 350 | 0.75 | 8.50 | 14.50 | 595 | — |
| 20 | 350 | 0.80 | 9.50 | 16.88 | 665 | — |
| 24 | 350 | 0.61 | 7.50 | 14.50 | 620 | — |
| 30 | 250 | 0.66 | 10.50 | 19.92 | 1010 | — |
| 36 | 250 | 0.74 | 12.00 | 23.54 | 1395 | — |
| 42 | 250 | 0.82 | 14.00 | 27.20 | 2235 | — |
| 48 | 250 | 0.90 | 15.00 | 29.60 | 2960 | — |
| 54 | 250 | 0.90 | 20.28 | 42.32 | — | 3070 |
| 60 | 250 | 0.94 | 21.26 | 44.08 | — | 3560 |
| 64 | 250 | 0.99 | 22.24 | 45.85 | — | 4085 |

*AWWA C153 configurations with shorter center-to-socket dimensions, etc., may be furnished in some cases in the 18"-20" size range. **Contact AMERICAN** if dimensions are critical.

**30 and larger Flex-Ring and Lok-Ring 45° Bends may be furnished with Flex-Ring Ends or Lok-Ring Ends. See Table No. 4-2.

† Higher pressure ratings are available on special applications. **Based on performance testing per AWWA C153, AMERICAN can rate 30"-48" C153 bends 350 psi. Contact AMERICAN.**

†† 16" Flex-Ring fittings may have greater "T" dimensions than those shown.

See General Notes on page 4-2.



AMERICAN Ductile Iron Flex-Ring® and Lok-Ring® Fittings
ANSI/AWWA C153/A21.53* and AMERICAN Standard
22 1/2° Bends (1/16th)

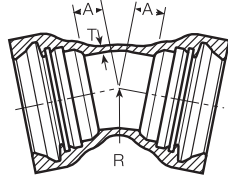

Flex-Ring Bell-Bell**

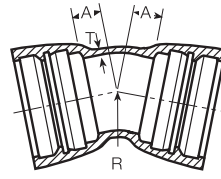

Lok-Ring Bell-Bell**

Table No. 4-6

| Size in. | Pressure† Rating psi | Dimensions in Inches | | | Weight in Pounds | |
|----------|----------------------|----------------------|-------|-------|------------------|----------|
| | | T | A | R | Flex-Ring | Lok-Ring |
| 4 | 350 | 0.34 | 1.50 | 2.51 | 42 | — |
| 6 | 350 | 0.36 | 2.00 | 5.03 | 56 | — |
| 8 | 350 | 0.38 | 2.50 | 6.94 | 76 | — |
| 10 | 350 | 0.40 | 3.00 | 8.80 | 120 | — |
| 12 | 350 | 0.42 | 3.50 | 10.05 | 198 | — |
| 16 | 350 | 0.50†† | 8.00 | 27.62 | 430 | — |
| 18 | 350 | 0.75 | 8.50 | 30.19 | 600 | — |
| 20 | 350 | 0.80 | 9.50 | 35.19 | 670 | — |
| 24 | 350 | 0.61 | 4.50 | 15.10 | 525 | — |
| 30 | 250 | 0.66 | 6.75 | 22.60 | 900 | — |
| 36 | 250 | 0.74 | 7.75 | 27.70 | 1220 | — |
| 42 | 250 | 0.82 | 9.00 | 31.40 | 1972 | — |
| 48 | 250 | 0.90 | 10.00 | 36.50 | 2630 | — |
| 54 | 250 | 0.90 | 10.24 | 37.65 | — | 2305 |
| 60 | 250 | 0.94 | 10.63 | 38.36 | — | 2650 |
| 64 | 250 | 0.99 | 11.02 | 39.06 | — | 3000 |

*AWWA C153 configurations with shorter center-to-socket dimensions, etc., may be furnished in some cases in the 18"-20" size range. Contact AMERICAN if dimensions are critical.

**30" and larger Flex-Ring and Lok-Ring 22 1/2° bends may be furnished with Flex-Ring Ends or Lok-Ring Ends. See Table No. 4-2.

† Higher pressure ratings are available on special applications. Based on performance testing per AWWA C153, AMERICAN can rate 30"-48" C153 bends 350 psi. Contact AMERICAN.

†† 16" Flex-Ring fittings may have greater "T" dimensions than those shown. See General Notes on page 4-2.



AMERICAN Ductile Iron Flex-Ring® and Lok-Ring® Fittings
ANSI/AWWA C153/A21.53* and AMERICAN Standard
11 1/4° Bends (1/32nd)

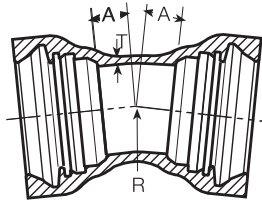

Flex-Ring Bell-Bell**

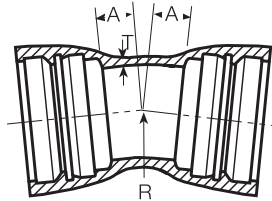

Lok-Ring Bell-Bell**

Table No. 4-7

| Size in. | Pressure† Rating psi | Dimensions in Inches | | | Weight in Pounds | |
|----------|----------------------|----------------------|------|-------|------------------|----------|
| | | T | A | R | Flex-Ring | Lok-Ring |
| 4 | 350 | 0.34 | 1.25 | 2.54 | 41 | — |
| 6 | 350 | 0.36 | 1.50 | 5.08 | 54 | — |
| 8 | 350 | 0.38 | 1.75 | 6.40 | 72 | — |
| 10 | 350 | 0.40 | 2.00 | 7.61 | 114 | — |
| 12 | 350 | 0.42 | 2.25 | 7.61 | 187 | — |
| 16 | 350 | 0.50†† | 8.00 | 55.81 | 430 | — |
| 18 | 350 | 0.75 | 8.50 | 60.94 | 605 | — |
| 20 | 350 | 0.80 | 9.50 | 71.06 | 675 | — |
| 24 | 350 | 0.89 | 3.00 | 15.33 | 490 | — |
| 30 | 250 | 0.66 | 4.75 | 25.40 | 830 | — |
| 36 | 250 | 0.74 | 5.00 | 27.90 | 1100 | — |
| 42 | 250 | 0.82 | 6.00 | 33.00 | 1934 | — |
| 48 | 250 | 0.90 | 6.50 | 33.50 | 2350 | — |
| 54 | 250 | 0.90 | 6.50 | 38.07 | — | 2000 |
| 60 | 250 | 0.94 | 7.00 | 40.61 | — | 2320 |
| 64 | 250 | 0.99 | 7.00 | 38.07 | — | 2590 |

*AWWA C153 configurations with shorter center-to-socket dimensions, etc., may be furnished in some cases in the 18"–20" size range. Contact AMERICAN if dimensions are critical.

**30" and larger Flex-Ring and Lok-Ring 11 1/4° bends may be furnished with Flex-Ring Ends or Lok-Ring Ends. See Table No. 4-2.

† Higher pressure ratings are available on special applications. Based on performance testing per AWWA C153, AMERICAN can rate 30"–48" C153 bends 350 psi. Contact AMERICAN.

††16" Flex-Ring fittings may have greater "T" dimensions than those shown.

See General Notes on page 4-2.



AMERICAN Ductile Iron Flex-Ring® and Lok-Ring® Fittings
ANSI/AWWA C153/A21.53* and AMERICAN Standard

Tees and Crosses

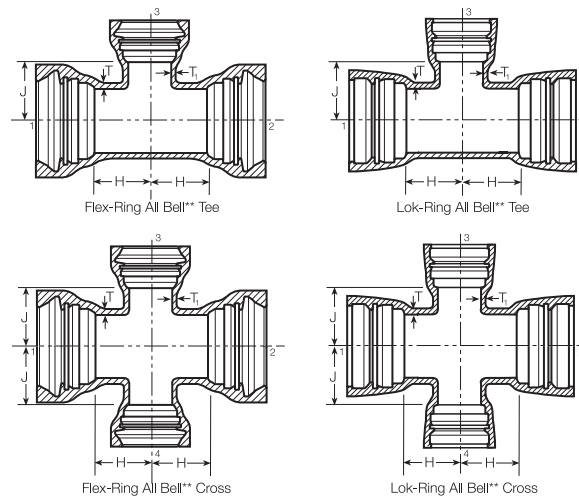

Table No. 4-8

| Size in. | | Pressure Rating psi † | Dimensions in Inches | | | | Weight in Pounds | | | |
|----------|--------|-----------------------|----------------------|----------------|------|------|----------------------|---------------------|----------------------|---------------------|
| Run | Branch | | T | T ₁ | H | J | Tee | | Cross | |
| | | | | | | | **Flex-Ring All Bell | **Lok-Ring All Bell | **Flex-Ring All Bell | **Lok-Ring All Bell |
| 4 | 4 | 350 | 0.34 | 0.34 | 4.00 | 4.00 | 68 | - | - | - |
| 6 | 4 | 350 | 0.36 | 0.34 | 4.00 | 5.00 | 84 | - | - | - |
| 6 | 6 | 350 | 0.36 | 0.36 | 5.00 | 5.00 | 93 | - | - | - |
| 8 | 4 | 350 | 0.38 | 0.34 | 4.00 | 6.50 | 104 | - | - | - |
| 8 | 6 | 350 | 0.38 | 0.36 | 5.00 | 6.50 | 115 | - | - | - |
| 8 | 8 | 350 | 0.38 | 0.38 | 6.50 | 6.50 | 131 | - | - | - |
| 10 | 4 | 350 | 0.40 | 0.34 | 4.00 | 7.50 | 148 | - | - | - |
| 10 | 6 | 350 | 0.40 | 0.36 | 5.00 | 7.50 | 160 | - | - | - |
| 10 | 8 | 350 | 0.40 | 0.38 | 6.50 | 7.50 | 178 | - | - | - |
| 10 | 10 | 350 | 0.40 | 0.40 | 7.50 | 7.50 | 204 | - | - | - |
| 12 | 4 | 350 | 0.42 | 0.34 | 4.00 | 8.75 | 222 | - | - | - |
| 12 | 6 | 350 | 0.42 | 0.36 | 5.00 | 8.75 | 237 | - | - | - |
| 12 | 8 | 350 | 0.42 | 0.38 | 6.50 | 8.75 | 257 | - | - | - |
| 12 | 10 | 350 | 0.42 | 0.40 | 7.50 | 8.75 | 284 | - | - | - |
| 12 | 12 | 350 | 0.42 | 0.42 | 8.75 | 8.75 | 330 | - | - | - |
| 16 | 4 | 350 | .50†† | .34†† | 15.0 | 15.0 | 645 | - | - | - |
| 16 | 6 | 350 | .50†† | .36†† | 15.0 | 15.0 | 655 | - | 705 | - |
| 16 | 8 | 350 | .50†† | .38†† | 15.0 | 15.0 | 670 | - | 730 | - |
| 16 | 10 | 350 | .50†† | .40†† | 15.0 | 15.0 | 705 | - | - | - |
| 16 | 12 | 350 | .50†† | .42†† | 15.0 | 15.0 | 730 | - | 850 | - |
| 16 | 14 | 350 | .50†† | .47†† | 15.0 | 15.0 | 775 | - | - | - |
| 16 | 16 | 350 | .50†† | .50†† | 15.0 | 15.0 | 805 | - | 1000 | - |

16" and 24"-64" fittings are generally per AWWA C153. While AWWA C153 shows 54"-64" fittings with 150 psi ratings, AMERICAN rates many 54"-64" fittings 250 psi as AMERICAN Standard based on performance testing. **30" and larger Flex-Ring and Lok-Ring Tees and Crosses may be furnished on the runs with Flex-Ring Ends or Lok-Ring Ends. See Table No. 4-2.

† Higher pressure ratings are available on special applications. Contact AMERICAN.

Note: Tees and Crosses with smaller reductions may be available; however, welded-on outlets are normally preferable in these cases from a layout, installation, and economical standpoint. See Section 7.

†† 16" Flex-Ring fittings may have greater "T" and "T₁" dimensions than those shown.

See General Notes on page 4-2.



AMERICAN Ductile Iron Flex-Ring® and Lok-Ring® Fittings
ANSI/AWWA C153/A21.53* and AMERICAN Standard
Tees and Crosses

Table No. 4-8 —Continued

| Size in. | | Pressure Rating psi † | Dimensions in Inches | | | | Weight in Pounds | | | |
|----------|--------|-----------------------|----------------------|----------------|------|------|----------------------|---------------------|----------------------|---------------------|
| | | | T | T ₁ | H | J | Tee | | Cross | |
| Run | Branch | | | | | | **Flex-Ring All Bell | **Lok-Ring All Bell | **Flex-Ring All Bell | **Lok-Ring All Bell |
| 18 | 6 | 350 | 0.75 | 0.55 | 13.0 | 15.5 | 810 | — | 850 | — |
| 18 | 8 | 350 | 0.75 | 0.60 | 13.0 | 15.5 | 820 | — | 880 | — |
| 18 | 10 | 350 | 0.75 | 0.68 | 13.0 | 15.5 | 855 | — | 940 | — |
| 18 | 12 | 350 | 0.75 | 0.75 | 13.0 | 15.5 | 875 | — | 990 | — |
| 18 | 14 | 350 | 0.75 | 0.66 | 16.5 | 16.5 | 1015 | — | 1185 | — |
| 18 | 16 | 350 | 0.75 | 0.70 | 16.5 | 16.5 | 1045 | — | 1240 | — |
| 18 | 18 | 350 | 0.75 | 0.75 | 16.5 | 16.5 | 1125 | — | 1405 | — |
| 20 | 6 | 350 | 0.80 | 0.55 | 14.0 | 17.0 | 905 | — | 950 | — |
| 20 | 8 | 350 | 0.80 | 0.60 | 14.0 | 17.0 | 920 | — | 980 | — |
| 20 | 10 | 350 | 0.80 | 0.68 | 14.0 | 17.0 | 950 | — | 1040 | — |
| 20 | 12 | 350 | 0.80 | 0.75 | 14.0 | 17.0 | 975 | — | 1090 | — |
| 20 | 14 | 350 | 0.80 | 0.66 | 14.0 | 17.0 | 1020 | — | 1175 | — |
| 20 | 16 | 350 | 0.80 | 0.70 | 18.0 | 18.0 | 1170 | — | 1365 | — |
| 20 | 18 | 350 | 0.80 | 0.75 | 18.0 | 18.0 | 1255 | — | 1530 | — |
| 20 | 20 | 350 | 0.80 | 0.80 | 18.0 | 18.0 | 1270 | — | 1565 | — |
| 24 | 6 | 350 | 0.61 | 0.36 | 13.0 | 17.0 | 920 | — | 870 | — |
| 24 | 8 | 350 | 0.61 | 0.38 | 13.0 | 17.0 | 930 | — | 900 | — |
| 24 | 10 | 350 | 0.61 | 0.40 | 13.0 | 17.0 | 950 | — | 935 | — |
| 24 | 12 | 350 | 0.61 | 0.42 | 13.0 | 17.0 | 965 | — | 965 | — |
| 24 | 14 | 350 | 0.61 | 0.47 | 13.0 | 17.0 | 990 | — | 1020 | — |
| 24 | 16 | 350 | 0.61 | 0.50 | 13.0 | 17.0 | 1005 | — | 1060 | — |
| 24 | 18 | 350 | 0.61 | 0.54 | 17.0 | 17.0 | 1035 | — | 1225 | — |
| 24 | 20 | 350 | 0.61 | 0.57 | 17.0 | 17.0 | 1050 | — | 1265 | — |
| 24 | 24 | 350 | 0.61 | 0.61 | 17.0 | 17.0 | 1130 | — | 1380 | — |
| 30 | 20 | 250 | 0.66 | 0.57 | 16.5 | 21.0 | 1500 | — | — | — |
| 30 | 24 | 250 | 0.66 | 0.61 | 22.0 | 22.0 | 1840 | — | 2070 | — |
| 30 | 30 | 250 | 0.66 | 0.66 | 22.0 | 22.0 | 2000 | — | 2480 | — |
| 36 | 24 | 250 | 0.74 | 0.61 | 18.5 | 26.0 | 2070 | — | — | — |
| 36 | 30 | 250 | 0.74 | 0.66 | 26.0 | 26.0 | 2670 | — | 3390 | — |
| 36 | 36 | 250 | 0.74 | 0.74 | 26.0 | 26.0 | 2740 | — | 3400 | — |

16" and 24"-64" fittings are generally per AWWA C153. While AWWA C153 shows 54"-64" fittings with 150 psi ratings, AMERICAN rates many 54"-64" fittings 250 psi as AMERICAN Standard based on performance testing.

**30" and larger Flex-Ring and Lok-Ring Tees and Crosses may be furnished on the runs with Flex-Ring Ends or Lok-Ring Ends. See Table No. 4-2.

† Higher pressure ratings are available on special applications. **Contact AMERICAN.**

Note: Tees and Crosses with smaller reductions may be available; however, welded-on outlets are normally preferable in these cases from a layout, installation, and economical standpoint. See Section 7.



AMERICAN Ductile Iron Flex-Ring® and Lok-Ring® Fittings
ANSI/AWWA C153/A21.53* and AMERICAN Standard
Tees and Crosses

Table No. 4-8 —Continued

| Size in. | | Pressure Rating psi † | Dimensions in Inches | | | | Weight in Pounds | | | |
|----------|--------|-----------------------|----------------------|----------------|-------|----------------------|---------------------|----------------------|---------------------|-------|
| | | | T | T ₁ | H | J | Tee | | Cross | |
| Run | Branch | | | | | **Flex-Ring All Bell | **Lok-Ring All Bell | **Flex-Ring All Bell | **Lok-Ring All Bell | |
| 42 | 24 | 250 | 0.82 | 0.61 | 22.0 | 27.5 | 3370 | — | 3570 | — |
| 42 | 30 | 250 | 0.82 | 0.66 | 22.0 | 29.5 | 3340 | — | 3860 | — |
| 42 | 36 | 250 | 0.82 | 0.74 | 30.0 | 30.0 | 3300 | — | 4670 | — |
| 42 | 42 | 250 | 0.82 | 0.82 | 30.0 | 30.0 | 4830 | — | 6970 | — |
| 48 | 24 | 250 | 0.90 | 0.61 | 23.0 | 32.0 | 3820 | — | — | — |
| 48 | 30 | 250 | 0.90 | 0.66 | 23.0 | 32.0 | 4180 | — | 4610 | — |
| 48 | 36 | 250 | 0.90 | 0.74 | 33.5 | 32.3 | 5190 | — | 5760 | — |
| 48 | 42 | 250 | 0.90 | 0.82 | 33.5 | 33.5 | 5600 | — | 6550 | — |
| 48 | 48 | 250 | 0.90 | 0.90 | 33.5 | 33.5 | 6130 | — | 7680 | — |
| 54 | 30 | 250 | 1.05 | 1.03 | 29.3 | 37.0 | — | 5086 | — | 5729 |
| 54 | 36 | 250 | 1.05 | 1.15 | 29.28 | 37.0 | — | — | — | 6380 |
| 54 | 42 | 250 | 1.05 | 1.28 | 38.59 | 39.0 | — | 6557 | — | — |
| 54 | 48 | 250 | 1.05 | 1.42 | 38.59 | 39.0 | — | 7001 | — | — |
| 54 | 54 | 250 | 1.05 | 1.05 | 38.59 | 38.59 | — | 8279 | — | 15774 |
| 60 | 36 | 250 | 1.10 | 1.15 | 29.53 | 39.0 | — | — | — | 6760 |
| 60 | 42 | 250 | 1.10 | 1.28 | 29.53 | 41.0 | — | 6428 | — | — |
| 60 | 48 | 250 | 1.10 | 1.42 | 40.95 | 41.0 | — | 8025 | — | — |
| 60 | 54 | 250 | 1.10 | 1.05 | 40.95 | 40.7 | — | 8913 | — | 11125 |
| 60 | 60 | 250 | 1.10 | 1.10 | 40.95 | 40.95 | — | 9975 | — | 12619 |
| 64 | 36 | 250 | 1.16 | 1.15 | 34.25 | 42.0 | — | — | — | 8360 |
| 64 | 42 | 250 | 1.16 | 1.28 | 34.25 | 42.0 | — | 7622 | — | 8708 |
| 64 | 48 | 250 | 1.16 | 1.42 | 34.25 | 44.0 | — | 8815 | — | — |
| 64 | 54 | 250 | 1.16 | 1.05 | 43.31 | 44.0 | — | 10336 | — | — |
| 64 | 60 | 250 | 1.16 | 1.10 | 43.31 | 44.0 | — | 10770 | — | — |
| 64 | 64 | 250 | 1.16 | 1.16 | 43.31 | 43.31 | — | 11806 | — | 14884 |

16" and 24"–64" fittings are generally per AWWA C153. While AWWA C153 shows 54"–64" fittings with 150 psi ratings, AMERICAN rates many 54"–64" fittings 250 psi as AMERICAN Standard based on performance testing.

† Higher pressure ratings are available on special applications. **Contact AMERICAN.**

Note: Tees and Crosses with smaller reductions may be available; however, welded-on outlets are normally preferable in these cases from a layout, installation, and economical standpoint. See Section 7.



AMERICAN Ductile Iron Flex-Ring® and Lok-Ring® Fittings
ANSI/AWWA C153/A21.53* and AMERICAN Standard

Reducers

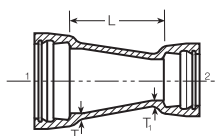

Bell and Bell

Table No. 4-9

| Size in. | | Pressure Rating psi† | Thickness in Inches | | Bell x Bell | |
|-----------|-----------|----------------------|---------------------|--------------------------|---------------------|-----------|
| Large End | Small End | | T Large End | T ₁ Small End | L Laying Length in. | Weight lb |
| 6 | 4 | 350 | 0.36 | 0.34 | 4 | 49 |
| 8 | 4 | 350 | 0.38 | 0.34 | 5 | 60 |
| 8 | 6 | 350 | 0.38 | 0.36 | 4 | 64 |
| 10 | 4 | 350 | 0.40 | 0.34 | 7 | 85 |
| 10 | 6 | 350 | 0.40 | 0.36 | 5 | 88 |
| 10 | 8 | 350 | 0.40 | 0.38 | 4 | 93 |
| 12 | 4 | 350 | 0.42 | 0.34 | 9 | 128 |
| 12 | 6 | 350 | 0.42 | 0.36 | 7 | 130 |
| 12 | 8 | 350 | 0.42 | 0.38 | 5 | 133 |
| 12 | 10 | 350 | 0.42 | 0.40 | 4 | 149 |
| 16 | 6 | 350 | .50†† | .36†† | 11 | 135 |
| 16 | 8 | 350 | .50†† | .38†† | 9 | 137 |
| 16 | 10 | 350 | .50†† | .40†† | 7 | 139 |
| 16 | 12 | 350 | .50†† | .42†† | 5 | 137 |
| 16 | 14 | 350 | .50†† | .47†† | 4 | 160 |
| 18 | 8 | 350 | 0.75 | 0.60 | 19 | 410 |
| 18 | 10 | 350 | 0.75 | 0.68 | 19 | 449 |
| 18 | 12 | 350 | 0.75 | 0.75 | 19 | 491 |
| 18 | 14 | 350 | 0.75 | 0.66 | 19 | 533 |
| 18 | 16 | 350 | 0.75 | 0.70 | 19 | 565 |
| 20 | 8 | 350 | 0.80 | 0.60 | 20 | 423 |
| 20 | 10 | 350 | 0.80 | 0.68 | 20 | 467 |
| 20 | 12 | 350 | 0.80 | 0.75 | 20 | 504 |
| 20 | 14 | 350 | 0.80 | 0.66 | 20 | 546 |
| 20 | 16 | 350 | 0.80 | 0.70 | 20 | 583 |
| 20 | 18 | 350 | 0.80 | 0.75 | 20 | 579 |
| 24 | 12 | 350 | 0.89 | 0.75 | 24 | 706 |
| 24 | 14 | 350 | 0.89 | 0.66 | 24 | 748 |
| 24 | 16 | 350 | 0.89 | 0.70 | 24 | 785 |
| 24 | 18 | 350 | 0.89 | 0.75 | 24 | 786 |
| 24 | 20 | 350 | 0.89 | 0.80 | 24 | 885 |
| 30 | 12 | 250 | 1.03 | 0.75 | 30 | 910 |
| 30 | 16 | 250 | 1.03 | 0.70 | 30 | 985 |
| 30 | 18 | 250 | 1.03 | 0.75 | 30 | 1030 |
| 30 | 20 | 250 | 1.03 | 0.80 | 30 | 1080 |
| 30 | 24 | 250 | 1.03 | 0.89 | 30 | 1210 |

*AWWA C153 configurations with shorter center-to-socket dimensions, etc., may be furnished in some cases in the 18"-48" size range.

Contact AMERICAN if dimensions are critical.

† Higher pressure ratings are available on special applications. Contact AMERICAN.

†† 16" Flex-Ring fittings may have greater "T" and "T₁" dimensions than those shown.

See General Notes on page 4-2.



AMERICAN Ductile Iron Flex-Ring® and Lok-Ring® Fittings
ANSI/AWWA C153/A21.53* and AMERICAN Standard

Reducers

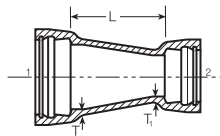

Bell and Bell

Table No. 4-9 — Continued

| Size in. | | Pressure Rating psi† | Thickness in Inches | | Bell x Bell** | |
|-----------|-----------|----------------------|---------------------|--------------------------|---------------------|-----------|
| Large End | Small End | | T Large End | T ₁ Small End | L Laying Length in. | Weight lb |
| 36 | 20 | 250 | 1.15 | 0.80 | 36 | 1490 |
| 36 | 24 | 250 | 1.15 | 0.89 | 36 | 1635 |
| 36 | 30 | 250 | 1.15 | 1.03 | 36 | 1925 |
| 42 | 20 | 250 | 1.28 | 0.80 | 42 | 1710 |
| 42 | 24 | 250 | 1.28 | 0.89 | 42 | 1875 |
| 42 | 30 | 250 | 1.28 | 1.03 | 42 | 2200 |
| 42 | 36 | 250 | 1.28 | 1.15 | 42 | 2540 |
| 48 | 24 | 250 | 1.42 | 0.89 | 48 | 2430 |
| 48 | 30 | 250 | 1.42 | 1.03 | 48 | 2790 |
| 48 | 36 | 250 | 1.42 | 1.15 | 48 | 3170 |
| 48 | 42 | 250 | 1.42 | 1.28 | 48 | 3315 |
| 54 | 30 | 250 | 0.90 | 1.00 | 31.25 | 2035 |
| 54 | 36 | 250 | 0.90 | 1.15 | 27.25 | 2180 |
| 54 | 42 | 250 | 0.90 | 1.25 | 19.25 | 1850 |
| 54 | 48 | 250 | 0.90 | 1.40 | 15.25 | 1890 |
| 60 | 30 | 250 | 0.94 | 1.00 | 35.5 | 2345 |
| 60 | 36 | 250 | 0.94 | 1.15 | 31.5 | 2505 |
| 60 | 42 | 250 | 0.94 | 1.25 | 23.5 | 2175 |
| 60 | 48 | 250 | 0.94 | 1.40 | 19.5 | 2230 |
| 60 | 54 | 250 | 0.94 | 0.90 | 10.25 | 1815 |
| 64 | 30 | 250 | 0.99 | 1.00 | 39.25 | 2690 |
| 64 | 36 | 250 | 0.99 | 1.15 | 35.25 | 2860 |
| 64 | 42 | 250 | 0.99 | 1.25 | 27.25 | 2525 |
| 64 | 48 | 250 | 0.99 | 1.40 | 23.25 | 2590 |
| 64 | 54 | 250 | 0.99 | 0.90 | 14.5 | 2145 |
| 64 | 60 | 250 | 0.99 | 0.94 | 10.25 | 2050 |

*AWWA C153 configurations with shorter center-to-socket dimensions, etc., may be furnished in some cases in the 18"-48" size range.

Contact AMERICAN if dimensions are critical.

**Reducers may be furnished with Flex-Ring or Lok-Ring bells and Flex-Ring or Lok-Ring ends in larger sizes. Dimensions (including laying lengths in some cases) and weights will be different than those shown above. Plain ends on available reducers may or may not be beveled/smoothed for push-on joint assembly. If push-on assembly is required, such ends may require field bevel/smoothing.

Contact AMERICAN if further information is needed. See Table No. 4-2 and 7-4.

† Higher pressure ratings are available on special applications. Contact AMERICAN.

See General Notes on page 4-2.



American Ductile Iron Flex-Ring® and Lok-Ring® Fittings American Standard

Plugs

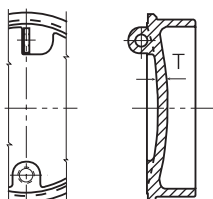

54"-64" Lok-Ring Plugs

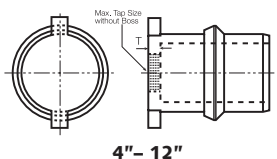

4"- 12"

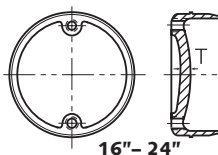

16"- 24"

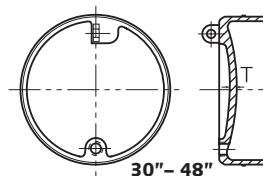

30"- 48"

Table No. 4-10

Flex-Ring Plugs

| Size in. | Pressure† Rating psi | T in. | Weight in Pounds | | |
|----------|----------------------|-------|--------------------|-----------|----------|
| | | | Push-On | Flex-Ring | Lok-Ring |
| 4 | 350 | 0.75 | See Table No. 4-11 | 19 | — |
| 6 | 350 | 0.75 | | 27 | — |
| 8 | 350 | 0.75 | | 39 | — |
| 10 | 350 | 0.87 | | 55 | — |
| 12 | 350 | 0.87 | | 70 | — |
| 16 | 250†† | — | — | 180 | — |
| 18 | 250†† | — | — | 220 | — |
| 20 | 250†† | — | — | 290 | — |
| 24 | 250†† | 1.16 | 350 | 440 | — |
| 30 | 250 | 1.37 | 565 | 620 | — |
| 36 | 250 | 1.58 | 785 | 1050 | — |
| 42 | 250 | 1.78 | 1355 | 1270 | — |
| 48 | 250 | 1.96 | 1670 | 1800 | — |
| 54 | 250 | 2.16 | 2415 | — | 1804 |
| 60 | 250 | 2.50 | 2680 | — | 2417 |
| 64 | 250 | 2.75 | 3230 | — | 2865 |

† Higher pressure ratings are available on special applications. Contact **AMERICAN**.

†† 16"-24" Flex-Ring Plugs are rated 350 psi.

All 4"-24" Push-On plugs are furnished with internal set-screw restraint. See Table No. 4-10 (above) for descriptions and ratings.

Fast-Grip® gaskets should not be used with plugs if disassembly would ever be required. Except as noted below, taps are furnished only when specified.

Steel eyebolts with 1" or 1 1/2" NPT male pipe threads can be obtained from AMERICAN to be threaded into these standard tapped holes to aid in non-destructive plug removal (pulling or jacking) operations.

16"-64" Lok-Ring and Flex-Ring plugs have one 1" (14"-24" sizes) or one 1 1/2" (30"-64" sizes) boss and tap (plugged) at invert and lifting eyes 180° from the boss. These taps facilitate testing and disassembly. If a different size or location of taps is required, it must be specified.

See General Notes on page 4-2.

It is not recommended to install 16"-48" Flex-Ring plugs into Flex-Ring valves.



Ductile Iron Push-On Restrained Plugs

Table No. 4-11

| Size in. | Pressure Rating psi | Weight lb |
|----------|---------------------|-----------|
| 4 | 250 | 15 |
| 6 | 250 | 30 |
| 8 | 250 | 50 |
| 10 | 250 | 70 |
| 12 | 250 | 100 |
| 14 | 250 | 155 |
| 16 | 250 | 200 |
| 18 | 250 | 260 |
| 20 | 250 | 410 |
| 24 | 250 | - |

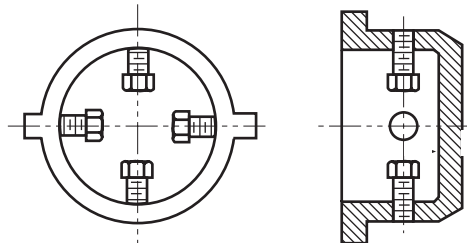

A-20803 Restrained Plug

The Fastite Restrained Plug provides positive locking against joint separation and allows for future removal. This plug is also useful as a test plug.

Fastite Conductive gaskets should not be used with Fastite Restrained Plugs.

See General Notes on page 4-2.

If desired, a 2" NPT tap can be ordered in 6"-20" plugs. A 1" tap can be supplied in 4" plugs.

Push-On Plug Assembly Instructions

The pictures illustrating these instructions are of small-diameter, restrained Fastite or Push-On plug assembly; however, other sizes and other push-on-type joint plugs may be assembled/disassembled with similar principles. In the case of various restrained joint plug designs, it is generally necessary to lock the plugs in accordance with the respective joint assembly instructions when restraint is desired, and also to appropriately unlock same if/when it is desired to remove them.



1. Clean the pipe socket of any foreign matter and insert the gasket. Lubricate the end of the plug and inside surface of gasket with a thin film of lubricant. A non-soluble lubricant, such as Fastite underwater lubricant, may be used to facilitate removal of the plug after testing.

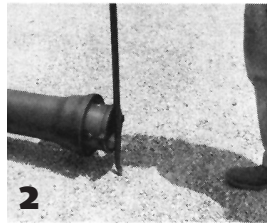

2. Place the tapered end of the plug in contact with the gasket in the pipe. Push the plug "home" into the pipe socket with a bar, lever, or jack, as required.

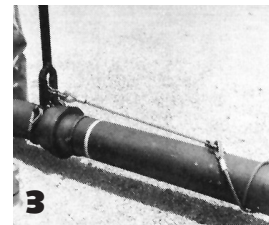

3. Larger sizes are easily assembled by placing another pipe against the plug and pushing or pulling the plug "home" using standard Fastite assembly tools or methods.



4. Firmly install the locking means if needed for restraint in the case of small-diameter Push-On plugs, tighten all cap screws inside the plug, and the assembly is then complete.

To remove the plug, release any locking mechanism present in accordance with normal joint disassembly instructions. In the case of Push-On plugs, back out the cap screws. Then, pull or jack the plug out of the socket. In the case of small-diameter, Push-On plugs, the plug can often be pried out with bars placed between the pipe bell and the cast lugs on the plug.



AMERICAN Ductile Iron Flex-Ring® and Lok-Ring® Fittings
AMERICAN Standard
Caps

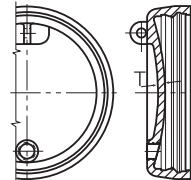
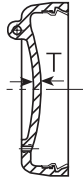
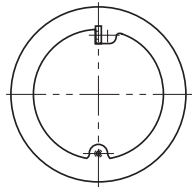

4"-48" Flex-Ring Caps

54"-64" Lok-Ring Caps

Table No. 4-12

| Size in. | Pressure† Rating psi | T in | Weight in Pounds | |
|----------|----------------------|------|------------------|----------|
| | | | Flex-Ring | Lok-Ring |
| 4 | 350 | 0.75 | 21 | — |
| 6 | 350 | 0.75 | 33 | — |
| 8 | 350 | 0.75 | 51 | — |
| 10 | 350 | 0.75 | 67 | — |
| 12 | 350 | 0.75 | 86 | — |
| 16 | 250†† | 0.89 | 273 | — |
| 18 | 250†† | 0.96 | 341 | — |
| 20 | 250†† | 1.03 | 429 | — |
| 24 | 250†† | 1.16 | 611 | — |
| 30 | 250 | 1.37 | 894 | — |
| 36 | 250 | 1.58 | 1321 | — |
| 42 | 250 | 2.25 | 2190 | — |
| 48 | 250 | 2.38 | 2625 | — |
| 54 | 250 | 2.43 | — | 3307 |
| 60 | 250 | 2.50 | — | 3853 |
| 64 | 250 | 2.75 | — | 4554 |

† Higher pressure ratings are available on special applications. Contact AMERICAN.

†† 16"-24" Flex-Ring Caps are rated 350 psi.

16"-64" Lok-Ring or Flex-Ring caps have one 1" (16"-24" sizes) or one 1 1/2" (30"-64" sizes) boss and tap (plugged) at invert and lifting eyes 180° from the boss. These taps facilitate testing or disassembly. If different size or location of taps is required, it must be specified.

See General Notes on page 4-2.



ASSEMBLY OF LOK-RING® PLUGS

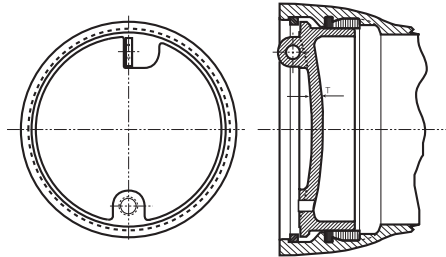

Typical Lok-Ring Plug

NOTE: A Lok-Ring plug, in effect, simulates the spigot end of a Lok-Ring pipe or fitting, with the outside face of the plug bulkhead plate roughly even with the bearing face of the plug abutment (simulating the weld ring on a pipe end). The Lok-Ring plug is normally shipped with the Lok-Ring bolted down (in effect, backward) on the beveled plain end barrel of the plug. This Lok-Ring is completely removed prior to insertion of the plug completely inside a socket, then the Lok-Ring is inserted and spread completely into the socket locking groove (in effect, behind the plug) to restrain it in the socket.

Assembly Instructions:

1. Remove (unbolt) the Lok-Ring completely off the plug by wrenching or manipulating only the outside closure nut opposite the locked (nut) side of the closure mechanism.
2. Prepare spigot and sockets, insert gasket, and lubricate the plug spigot end and gasket in accordance with basic Fastite (and Lok-Ring) joint assembly instructions. See page 2-10.
3. Push or pull the plug completely inside the socket. Due to the short nature of the push-on joint plug, some means is normally necessary to stabilize or brace the plug so that it does not pivot or "buck sideways" in joint assembly. A longer pipe, the end of which can be placed against the outside face of the plug, or a (large bearing face) timber braced between the plug face and the flat lower face of a backhoe bucket are normally quite effective for this purpose. Of course, if the end of a pipe is used to push the plug in, any conventional pipe assembly means could be used to pull or push the pipe and the plug into the socket. Sufficient socket locking groove "width" should be clearly visible after pushing the plug inside the socket to allow insertion of the Lok-Ring.
4. Compress the ends of the loose Lok-Ring together and push it completely into the socket locking groove to restrain the plug in the socket.
5. Wrenching only the inside spreader nut opposite the locked side of the closure mechanism, mechanically spread the Lok-Ring into firm contact with the inner socket surface of the socket locking groove.
6. Inspect the installed Lok-Ring making sure that the ring is completely inserted in the socket locking groove and completely restrained by the socket restraint lip from one end of the ring to the other end all around the joint. If the ring is out of the groove at any point, correct this condition prior to applying any pressure load to the plug.



PUSH-ON FITTING ASSEMBLY INSTRUCTIONS

ASSEMBLY INSTRUCTIONS

Assembling AMERICAN Lok-Ring® and Flex-Ring® fittings is simple. It is very similar to the assembly of Fastite pipe shown in Section 2. (For instructions on complete assembly of Fast-Grip®, Flex-Ring, Field Flex-Ring®, and Lok-Ring joints, check Section 9.)

Fast-Grip gaskets may be used in lieu of standard Fastite gaskets in the bells of same size (4" -30") Fastite and Flex-Ring joint pipe or fittings where easy, field-adaptable restraint is desired in pipelines with working pressure from 150-350 psi, depending on size. No Flex-Ring restraining mechanism is necessary when using Fast-Grip gaskets in Flex-Ring bells.

Push-on fittings may be assembled on individual pipe aboveground, or assembled onto the pipeline belowground. Many installers, however, do prefer to pull restrained joint fittings, in particular Fast-Grip, Flex-Ring, etc., onto a piece of pipe aboveground. This is sometimes accomplished by simply bracing one end of the pipe against a heavy piece of equipment (e.g. backhoe) and pulling the fitting onto the far end of the pipe using the method shown below. Then the pipe and fitting can be lowered as a single unit into the trench. Fittings may be assembled above ground if a situation arises that would make trench assembly difficult. However, in this case the assembly yokes and pulling sling must be kept safely in place and the sling must remain taut while the assembly is lowered into the ground. This should prevent the fitting from slipping off the end of the pipe.

While it may be possible to "rotate" some push-on fittings (after they are assembled to fixed/in-situ piping), AMERICAN recommends that fittings be assembled in their actual service orientation.

1. CLEANING OF SOCKET AND SPIGOT

Clean the socket and plain end of the pipe thoroughly, removing mud, sand, gravel, ice, frozen material, or other matter that could prevent a proper joint seal. Material in the gasket grooves may cause the gasket to protrude into the path of the entering spigot. Therefore, **it is important that all joint recesses be kept clean during insertion of the gasket and assembly of the joint to prevent gasket dislodgment and/or subsequent leakage.**

2. PLACEMENT OF GASKET

Wipe the gasket clean. After flexing one or more "loops" in the gasket, insert the gasket in the gasket recess of the socket with the large sealing end of the gasket toward the rear of the socket (Photo 1). If Fast-Grip gaskets are used, the center of the gasket loops should be positioned between tooth locations. Press the gasket into the mating socket recesses so the metal-carrying retainer end of the gasket is seated completely and uniformly in the socket groove. Take care that no gasket loops or bulges protrude into the path of the entering pipe spigot. In extremely cold weather conditions, gaskets should be warmed before installing.

3. LUBRICATION OF THE JOINT

With a clean brush, apply a liberal amount of regular Fastite lubricant completely over the exposed inner surface of the gasket after it is placed in the socket (Photo 2). Also, apply lubricant completely over the plain end of the pipe, the spigot radius, and the outer surface of the pipe up to the assembly stripe (Photo 3). Use only lubricant provided by AMERICAN. For underwater or very wet conditions, special AMERICAN underwater lubricant is recommended and is available upon request. This special lubricant for underwater service is relatively insoluble in water immersion or exposure to flowing water.

4. INITIAL PLACEMENT OF BEVEL END INTO SOCKET†

The spigot end of the pipe should be in reasonably straight alignment when entered in the socket. Center the spigot in the installed gasket, so it makes firm and even contact with the inner surface of the gasket. Do not place pipe spigot in socket while in a substantially deflected position.

† Joints using Fast-Grip gaskets should be assembled in proper orientation so as to avoid rotation of the fitting after assembly. See Fast-Grip Gasket Assembly Instructions in Section 9.



PUSH-ON FITTING ASSEMBLY INSTRUCTIONS

ASSEMBLY INSTRUCTIONS-Continued

5. PULL-ON ASSEMBLY OF PUSH-ON FITTINGS AND RIGGING

Fittings may normally then be pulled readily onto pipe ends by first firmly supporting the fitting in aligned assembly position, and then pulling on the center of a wire rope or chain sling attached to the fitting bell with any suitable pulling mechanism (such as a backhoe, come-along(s), pry bar, etc.) until the spigot is fully inserted into the socket.

Larger-diameter fittings can be assembled with field-made rigging similar in function to the smaller custom steel yokes, but instead using a chain or wire rope sling, etc., looped under the spigot to, in similar effect, direct a single-point pulling force into two pulling sling legs straight at the springline. (See Photo 3.)

6. COMPLETE ASSEMBLY OF PLAIN END INTO SOCKET

Pull the sling with smooth, steady force until the fitting is "pulled up" and the plain end uniformly contacts the rear of the socket. It is best practice to make assemblies smoothly and progressively in one motion, without repeated "wobbling" (or joint deflection) back and forth. Desired joint deflection may then be set. Any abnormal joint assembly loads or behavior, such as unexplained exposure of the assembly stripe outside the bell, may indicate improper cleaning, gasket insertion, spigot placement, or lubrication. In any such

case, it may be advisable to feel for correct gasket positioning by passing a thin (automotive or other) feeler gauge between the bell and spigot all around the assembled joint.

Any joint with apparent problems (pushed gasket locations found by the probe, etc.) should be disassembled and corrected prior to filling or testing the pipeline. (See Section 9 for disassembly involving Fast-Grip gaskets or Field Flex-Rings.)

DOUBLE FITTING ASSEMBLY

In areas involving short lengths of pipe between two fittings, it may be desirable to simultaneously assemble the two fittings onto a single piece of pipe. This may be accomplished with AMERICAN push-on joint fittings due to the self-centering nature of the joints.

This "double assembly" procedure is similar to the single fitting assembly procedure mentioned earlier. In fact, Steps 1 through 4 are identical. For Step 5, place one yoke over the bell end of one of the fittings. Then, place the second yoke under the bell of the other fitting (Photo 4). Attach a wire rope sling (or other similar device) to the yokes in a manner similar to Step 5 (Photo 5). Note that both yokes can also be placed on the bottoms of the fittings for the same effect, if desired. Complete the assembly by simply pulling the ends of the sling with a pulling mechanism as in Step 5.

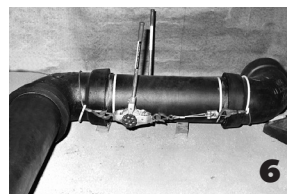
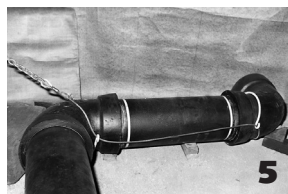
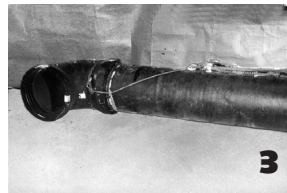
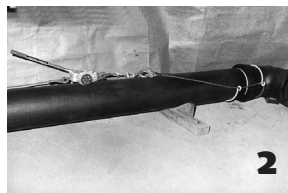
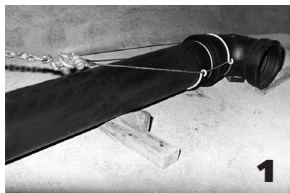



PUSH-ON FITTING ASSEMBLY INSTRUCTIONS

ASSEMBLY INSTRUCTIONS-Continued

Another method for the “double assembly” may be more convenient for pipes of sufficient length and any in-trench applications where there may not be easy means for sufficient bracing of the fitting. This method involves the use of two come-alongs (one on each side of the pipe) in order to provide a reasonably steady, evenly distributed assembly force. The assembly procedure is similar to the previously mentioned procedure. Place yokes on the fittings in the same manner as the other “double assembly” procedure (Photo 9). Then, place one short assembly sling under each of the two fittings and attach the sling to the yokes. Position the come-alongs on each side of the assembly and attach the sling thimbles or loops to both sides of the come-alongs (Photo 6). Work the come-alongs simultaneously to make a smooth, even assembly.

FIELD-CUT PIPE

When pipe is cut in the field, the cut end must be properly prepared prior to assembly

into the push-on socket. Using a portable grinder, place an approximately 1/4” to 1/2” long smooth assembly chamfer or bevel on the outside end of the pipe. This bevel should make an angle of 30°-40° with the axis of the pipe. Care should be taken to ensure that all corners are rounded and no sharp or rough edges remain that might damage or dislodge the gasket. Finally, it is good practice to mark at least a rough assembly stripe on the newly beveled pipe. The distance from the beveled end of the pipe to the opposite edge of the stripe should be about 1/8” less than the socket depth. (See Table No. 4-1 for typical socket depths of pipe or fittings, or measure same in the field.) This stripe is helpful in confirming proper joint insertion and also as an indication of joint deflection.

FIELD RIGGING EXAMPLE

Assembly of a larger push-on joint fitting.



NOTES:

*Larger-diameter fittings which cannot be assembled with equipment shown may be assembled using a similar procedure with heavier or stronger field rigging and more powerful equipment. (See example photos above.)

Final restrained joint pipe/fitting assemblies (connections to previously installed/fixed piping) should be assembled in proper orientation so as to avoid rotation of the fitting after assembly. See Fast-Grip Gasket Assembly Instructions in Restrained Joint Pipe (Section 9).

Section 5

AMERICAN Ductile Iron Mechanical Joint Fittings





AMERICAN Ductile Iron Mechanical Joint Fittings

The principal standards covering full body mechanical joint fittings are ANSI/AWWA C110/A21.10 and ANSI/AWWA C111/A21.11. Compact ductile iron fittings are covered in ANSI/AWWA C153/A21.53. These and other standards are referenced throughout this section either by the full ANSI/AWWA designation or by only the AWWA numbering, such as AWWA C110.

AMERICAN supplies a complete line of 4" through 48" mechanical joint fittings meeting the requirements of ANSI/AWWA C110/A21.10 or ANSI/AWWA C153/A21.53, with the joint meeting the requirements of ANSI/AWWA C111/A21.11. Also included in this section are fittings which are unusual as to size combination, joint combination, outlets, and other variations. These fittings are designated as "AMERICAN standard" and comply with the applicable requirements of the ANSI/AWWA standards.

Mechanical joint fittings have been used extensively in underground service with Fastite joint pipe as well as mechanical joint pipe. Since 48" is the maximum size mechanical joint, Fastite or Lok-Ring fittings are normally furnished with AMERICAN 54" and larger Fastite or Lok-Ring joint pipe.

While mechanical joint fittings have provided excellent service for decades, their use is currently being supplanted in many cases by Fastite, Flex-Ring, and Lok-Ring fittings. These fittings offer improved and less labor-intensive field assembly and performance, and their use should be considered in lieu of mechanical joint fittings in

most large-diameter applications. See Section 4.

When joint restraint is required underground or aboveground, several types of restrained joints are available from AMERICAN. See Sections 4 and 9.

The design of mechanical joint fittings is based on their use with pipe having outside diameters that are standard for mechanical joint and for Fastite joint pipe. In planning a mechanical joint connection to an old existing pipeline, the outside diameter should be carefully checked where connection is to be made.

Mechanical joint fittings are normally furnished complete with a gland, plain rubber gasket, and tee head alloy steel bolts with heavy hex nuts for each socket.

Ductile iron fittings for pressure ratings of 150, 250 and 350 psi are furnished as shown in the tables in this Section.

Fittings for water service are generally furnished with cement lining in accordance with AWWA C104 and with an outside asphaltic coating. They can also be furnished asphaltic coated or uncoated inside. For special conditions, other types of coatings and linings are available. See Section 11.



Installing a mechanical joint bend in a gravity sewer utilizing field-cut closure pieces to locate the fitting accurately.



General Notes Relating to Mechanical Joints

1. Fittings in the following tables with ANSI/AWWA standards listed in the heading are as specified in those standards. Fittings in tables with heading "AMERICAN standard" are either not included in the ANSI/AWWA standards or vary therefrom in weights and/or dimensions.

2. Fittings are manufactured of ductile iron meeting the requirements of AWWA C110 or C153, as applicable.

3. Weights of accessories are not included in weights of fittings shown in tables unless specifically noted. Where "Assembled Weight" is shown, joint materials are shipped assembled on the fitting. For weights of accessories, see Section 2.

4. Weights and dimensions of fittings can vary due to changes in foundry equipment.

5. Orientation of bolt holes in mechanical joint fittings with respect to any centerline* is not fixed. Where bolt holes are required to straddle the centerline of the fitting, this must be specified by the purchaser.

6. For allowable joint deflection of mechanical joints, see Section 2.

7. Mechanical joint flanges can normally be furnished tapped for studs when specified by the purchaser. See Section 2, Table No. 2-15.

8. All pressure ratings shown are for water service.

9. The ANSI/AWWA C110/A21.10 thicknesses of most mechanical joint fittings shown in tables in this section are the same thicknesses as Class "B" or "D" (most of them being Class "B") per the obsolete AWWA C100 standard; these thicknesses and corresponding outside diameters are shown in Section 12, Table No. 12-1.

10. Some fittings are available with body metal thickness other than as shown in the tables. Some fittings are available in different sizes and with different size combinations than shown. Check AMERICAN regarding special requirements.

11. See Section 7 for AMERICAN specials.

12. Locations of taps in mechanical joint fittings should be designated as shown on page 6-5 for flanged fittings.

13. MJ connecting pieces (MJ-MJ, MJ-PE, MJ-Flg, and Flg-PE) are furnished by AMERICAN as fabricated piping and can be furnished in variable lengths. See Sections 7 and 8.

14. Fittings may be furnished by AMERICAN manufactured by others. Any such fittings will be manufactured in accordance with appropriate ANSI/AWWA or AMERICAN standards.

15. Some configurations shown for both AWWA C110 and C153 may not be available both ways.

16. The thicknesses shown for C153 standard fittings are the nominal thicknesses shown in this standard. The shown lengths and center-to-socket dimensions of these fittings are minimum dimensions also in accordance with the C153 standard. Actual thicknesses of fittings will vary as allowed by the standard, and actual lengths and center-to-socket dimensions will generally be equal to or greater than those shown in the tables, all depending on foundry equipment.

17. AMERICAN manufactures 4" through 12" Mechanical Joint Ductile Iron pipe in accordance with AWWA C151 and AWWA C111 and Mechanical Joint fittings up through 48" in accordance with AWWA C153, AWWA C110, and AWWA C111, as described therein. However, AMERICAN does not warrant the performance of third-party mechanical retainer glands or joints using third-party retainer glands, since the design, manufacturing, and installation methods are beyond our control. AMERICAN does manufacture a number of restrained joints such as Fast-Grip®, Flex-Ring®, Field Flex-Ring®, Lok-Ring®, Flex-Lok®, and other devices, where we warrant the joint as well as the associated pipe and fittings of our manufacture.

*The normal but not universal practice is to have the bolt holes straddle the vertical centerline of a fitting, which is determined when the fitting is in the position to change the direction of fluid flowing in a horizontal plane. With standard base bends and standard base tees, the determination is made when the fitting is in position to change the direction of fluid flowing in a vertical plane.



AMERICAN Ductile Iron Mechanical Joint Fittings Applications of Standard Fittings

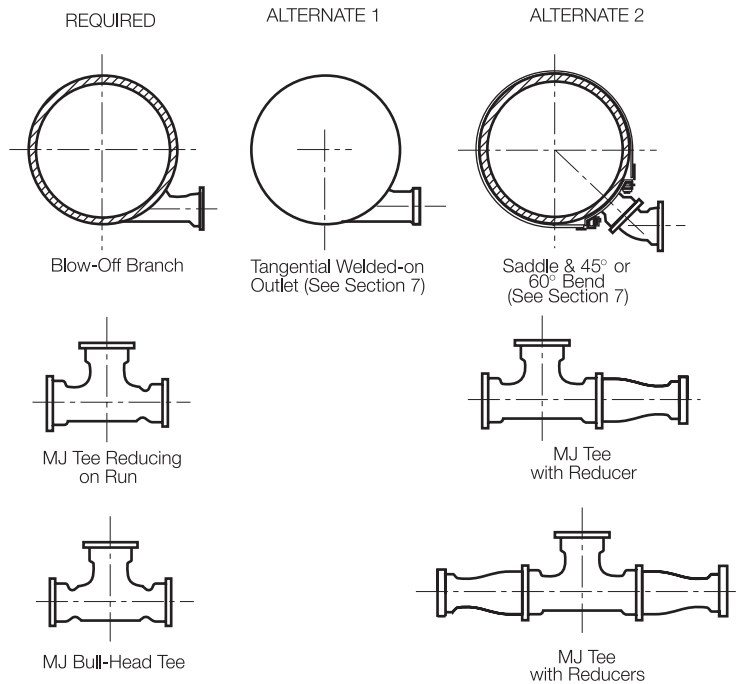
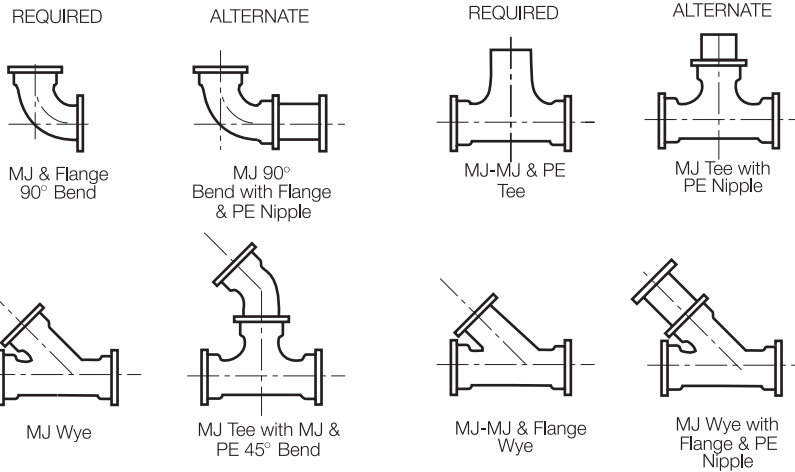

In many cases special fittings for various conditions are required; some of these are shown above in columns headed "Formerly Required." Under the columns headed "Preferred Alternate" are shown combinations of standard fittings which in some situations will provide the desired connection. For economy and availability, it is often advantageous to use the standard fittings.



AMERICAN Ductile Iron Mechanical Joint Fittings

ANSI/AWWA C110 and C153 Mechanical Joint Dimensions

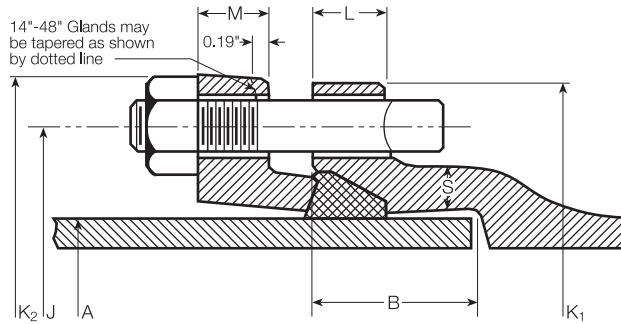

Table No. 5-1

| Size in. | Dimensions in Inches | | | | | | | | | Bolts | |
|-------------|----------------------|------|-------|----------------|----------------|------|------|------|------|------------------|---------------|
| | A Plain End | B | J | K ₁ | K ₂ | L | | M | S | No. per Joint | Size in. |
| | | | | | | C110 | C153 | | | | |
| 4 | 4.80 | 2.50 | 7.50 | 9.38 | 9.12 | 1.00 | .60 | .75 | .65 | 4 | 3/4 x 3 1/2 |
| 6 | 6.90 | 2.50 | 9.50 | 11.31 | 11.12 | 1.06 | .63 | .88 | .70 | 6 | 3/4 x 3 1/2 |
| 8 | 9.05 | 2.50 | 11.75 | 13.63 | 13.37 | 1.12 | .66 | 1.00 | .75 | 6 | 3/4 x 4 |
| 10 | 11.10 | 2.50 | 14.00 | 15.81 | 15.62 | 1.19 | .70 | 1.00 | .80 | 8 | 3/4 x 4 |
| 12 | 13.20 | 2.50 | 16.25 | 18.06 | 18.00 | 1.25 | .73 | 1.00 | .85 | 8 | 3/4 x 4 |
| 14 | 15.30 | 3.50 | 18.75 | 20.69 | 20.25 | 1.31 | .79 | 1.25 | .89 | 10 | 3/4 x 4 1/2 |
| 16 | 17.40 | 3.50 | 21.00 | 22.94 | 22.50 | 1.38 | .85 | 1.31 | .97 | 12 | 3/4 x 4 1/2 |
| 18 | 19.50 | 3.50 | 23.25 | 25.28 | 24.75 | 1.44 | 1.00 | 1.38 | 1.05 | 12 | 3/4 x 4 1/2 |
| 20 | 21.60 | 3.50 | 25.50 | 27.08 | 27.00 | 1.50 | 1.02 | 1.44 | 1.12 | 14 | 3/4 x 4 1/2 |
| 24 | 25.80 | 3.50 | 30.00 | 31.75 | 31.50 | 1.62 | 1.02 | 1.56 | 1.22 | 16 | 3/4 x 5 |
| 30 | 32.00 | 4.00 | 36.88 | 39.12 | 39.12 | 1.81 | - | 2.00 | 1.50 | 20 | 1 x 6 |
| 36 | 38.30 | 4.00 | 43.75 | 46.00 | 46.00 | 2.00 | - | 2.00 | 1.80 | 24 | 1 x 6 |
| 42 | 44.50 | 4.00 | 50.62 | 53.12 | 53.12 | 2.00 | - | 2.00 | 1.95 | 28 | 1 1/4 x 6 1/2 |
| 48 | 50.80 | 4.00 | 57.50 | 60.00 | 60.00 | 2.00 | - | 2.00 | 2.20 | 32 | 1 1/4 x 6 1/2 |

If dimensions and/or weights for this fitting are critical, please contact your AMERICAN customer service representative for assistance.

All center dimensions reflect the C153 standard minimum dimension.

For mechanical joints for pipe see Section 2.

For tolerances and additional dimensions see AWWA C111.

Bolt holes are 1/8" larger than the bolt diameters.

Mechanical Joint Retainer Gland designs (by others) often require longer than the above standard bolting. See Sections 9 and 12 regarding alternative restrained joints, and also retainer gland applications.



AMERICAN Ductile Iron Mechanical Joint Fittings

ANSI/AWWA C110/A21.10 Mechanical Joint Plain End Standard Dimensions

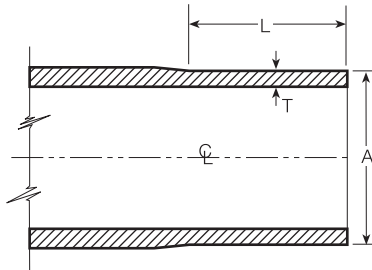

Table No. 5-2

| Size in. | Dimensions in Inches | | | Weight of (8" long) Plain End lb |
|-------------|----------------------|------|-----|--|
| | A | T | L | |
| 4 | 4.80 | .47 | 5.5 | 13 |
| 6 | 6.90 | .50 | 5.5 | 21 |
| 8 | 9.05 | .54 | 5.5 | 30 |
| 10 | 11.10 | .60 | 5.5 | 41 |
| 12 | 13.20 | .68 | 5.5 | 56 |
| 14 | 15.30 | .66 | 8.0 | 63 |
| 16 | 17.40 | .70 | 8.0 | 76 |
| 18 | 19.50 | .75 | 8.0 | 92 |
| 20 | 21.60 | .80 | 8.0 | 109 |
| 24 | 25.80 | .89 | 8.0 | 145 |
| 30 | 32.00 | 1.03 | 8.0 | 208 |
| 36 | 38.30 | 1.15 | 8.0 | 279 |
| 42 | 44.50 | 1.28 | 8.0 | 362 |
| 48 | 50.80 | 1.42 | 8.0 | 458 |

If dimensions and/or weights for this fitting are critical, please contact your AMERICAN customer service representative for assistance.

All center dimensions reflect the C153 standard minimum dimension.

The "L" dimension is minimum length of the plain end which must be gauged to ensure the outside diameter is within the dimensions and tolerances required.

The laying length of a plain end of an MJ fitting is 8" longer than the laying length of a bell end.

Plain ends of fittings may be furnished with beveled ends for assembly with either Fastite or mechanical joints.

However, if beveled ends are required they must be specified.



AMERICAN Ductile Iron Mechanical Joint Fittings

ANSI/AWWA C110/A21.10 and C153/A21.53 90° Bends (1/4th)

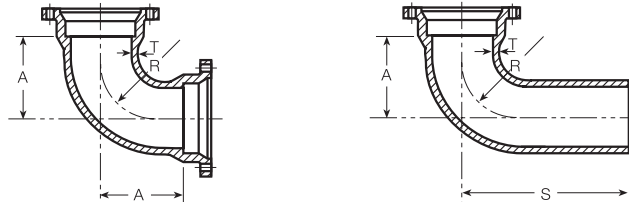

Table No. 5-3 MJ and MJ AWWA C110 MJ and PE

| Size in. | Pressure Rating psi | Dimensions in Inches | | | | Weight in Pounds | |
|----------|---------------------|----------------------|------|------|------|------------------|---------|
| | | T | A | S | R | MJ & MJ | MJ & PE |
| 4 | 350 | .52 | 6.5 | 14.5 | 4.5 | 55 | 50 |
| 6 | 350 | .55 | 8.0 | 16.0 | 6.0 | 85 | 80 |
| 8 | 350 | .60 | 9.0 | 17.0 | 7.0 | 125 | 120 |
| 10 | 350 | .68 | 11.0 | 19.0 | 9.0 | 190 | 190 |
| 12 | 350 | .75 | 12.0 | 20.0 | 10.0 | 255 | 255 |
| 14 | 350 | .66 | 14.0 | 22.0 | 11.5 | 340 | 325 |
| 16 | 350 | .70 | 15.0 | 23.0 | 12.5 | 430 | 410 |
| 18 | 350 | .75 | 16.5 | 24.5 | 14.0 | 545 | 520 |
| 20 | 350 | .80 | 18.0 | 26.0 | 15.5 | 680 | 650 |
| 24 | 350 | .89 | 22.0 | 30.0 | 18.5 | 1025 | 985 |
| 30 | 250 | 1.03 | 25.0 | 33.0 | 21.5 | 1690 | 1585 |
| 36 | 250 | 1.15 | 28.0 | 36.0 | 24.5 | 2475 | 2310 |
| 42 | 250 | 1.28 | 31.0 | 39.0 | 27.5 | 3410 | 3200 |
| 48 | 250 | 1.42 | 34.0 | 42.0 | 30.5 | 4595 | 4330 |

If dimensions and/or weights for this fitting are critical, please contact your AMERICAN customer service representative for assistance.

All center dimensions meet the C153 standard minimum dimension.

Table No. 5-4 AWWA C153 - Compact

| Size in. | Pressure Rating psi | Dimensions in Inches | | | Weight in Pounds | |
|----------|---------------------|----------------------|--------|--------|------------------|---------|
| | | T nom. | A min. | S min. | MJ & MJ | MJ & PE |
| 4 | 350 | .34 | 4.00 | 9.50 | 25 | 22 |
| 6 | 350 | .36 | 5.00 | 11.50 | 39 | 41 |
| 8 | 350 | .38 | 6.50 | 12.50 | 57 | 58 |
| 10 | 350 | .40 | 7.50 | 13.00 | 89 | 83 |
| 12 | 350 | .42 | 9.00 | 14.50 | 108 | 114 |
| 14 | 350 | .47 | 11.50 | 19.50 | 210 | 197 |
| 16 | 350 | .50 | 12.50 | 20.50 | 264 | 248 |
| 18 | 350 | .54 | 14.00 | 21.00 | 335 | 325 |
| 20 | 350 | .57 | 15.00 | 22.50 | 400 | 390 |
| 24 | 350 | .61 | 16.75 | 25.00 | 565 | 575 |
| 30 | 250* | .66 | 21.50 | 30.50 | 930 | 865 |
| 36 | 250* | .74 | 24.50 | 33.50 | 1450 | 1355 |
| 42 | 250* | .82 | 29.25 | 38.25 | 2205 | 2055 |
| 48 | 250* | .90 | 33.25 | 42.25 | 2990 | 2805 |

If dimensions and/or weights for this fitting are critical, please contact your AMERICAN customer service representative for assistance.

All center dimensions reflect the C153 standard minimum dimension.

*Based on performance testing per AWWA C153, AMERICAN can rate these fittings 350 psi. However, because of the more labor-intensive and labor-reliant assembly of the MJ joint and the substantial thrust restraint requirements for working pressures that high, we recommend push-on joint configurations (Fastite, Flex-Ring and Lok-Ring) for high pressure applications.



AMERICAN Ductile Iron Mechanical Joint Fittings

ANSI/AWWA C110/A21.10 and C153/A21.53 45° Bends (1/8th)

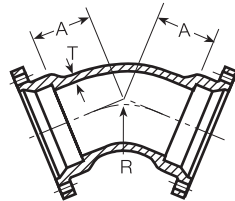

MJ and MJ

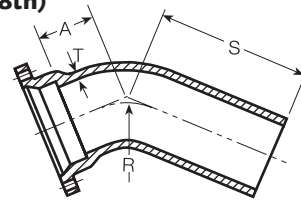

MJ and PE

Table No. 5-5 AWWA C110

| Size in. | Pressure Rating psi | Dimensions in Inches | | | | Weight in Pounds | |
|----------|---------------------|----------------------|------|------|-------|------------------|---------|
| | | T | A | S | R | MJ & MJ | MJ & PE |
| 4 | 350 | .52 | 4.0 | 12.0 | 4.81 | 50 | 45 |
| 6 | 350 | .55 | 5.0 | 13.0 | 7.25 | 75 | 70 |
| 8 | 350 | .60 | 5.5 | 13.5 | 8.44 | 110 | 105 |
| 10 | 350 | .68 | 6.5 | 14.5 | 10.88 | 155 | 155 |
| 12 | 350 | .75 | 7.5 | 15.5 | 13.25 | 215 | 215 |
| 14 | 350 | .66 | 7.5 | 15.5 | 12.06 | 270 | 255 |
| 16 | 350 | .70 | 8.0 | 16.0 | 13.25 | 340 | 320 |
| 18 | 350 | .75 | 8.5 | 16.5 | 14.50 | 420 | 395 |
| 20 | 350 | .80 | 9.5 | 17.5 | 16.88 | 530 | 500 |
| 24 | 350 | .89 | 11.0 | 19.0 | 18.12 | 755 | 715 |
| 30 | 250 | 1.03 | 15.0 | 23.0 | 27.75 | 1380 | 1275 |
| 36 | 250 | 1.15 | 18.0 | 26.0 | 35.00 | 2095 | 1930 |
| 42 | 250 | 1.28 | 21.0 | 29.0 | 42.25 | 2955 | 2745 |
| 48 | 250 | 1.42 | 24.0 | 32.0 | 49.50 | 4080 | 3815 |

If dimensions and/or weights for this fitting are critical, please contact your AMERICAN customer service representative for assistance.

All center dimensions meet the C153 standard minimum dimension.

Table No. 5-6 AWWA C153 - Compact

| Size in. | Pressure Rating psi | Dimensions in Inches | | | Weight in Pounds | |
|----------|---------------------|----------------------|--------|--------|------------------|---------|
| | | T nom. | A min. | S min. | MJ & MJ | MJ & PE |
| 4 | 350 | .34 | 2.0 | 7.5 | 22 | 19 |
| 6 | 350 | .36 | 3.0 | 8.5 | 32 | 34 |
| 8 | 350 | .38 | 3.5 | 9.0 | 46 | 49 |
| 10 | 350 | .40 | 4.5 | 10.0 | 70 | 69 |
| 12 | 350 | .42 | 5.5 | 11.0 | 86 | 93 |
| 14 | 350 | .47 | 5.0 | 13.0 | 160 | 146 |
| 16 | 350 | .50 | 5.5 | 13.5 | 202 | 184 |
| 18 | 350 | .54 | 6.0 | 13.0 | 250 | 235 |
| 20 | 350 | .57 | 7.0 | 14.0 | 305 | 290 |
| 24 | 350 | .61 | 7.5 | 14.5 | 405 | 390 |
| 30 | 250* | .66 | 10.5 | 19.5 | 780 | 715 |
| 36 | 250* | .74 | 11.5 | 21.0 | 1135 | 1040 |
| 42 | 250* | .82 | 14.0 | 23.0 | 1610 | 1460 |
| 48 | 250* | .90 | 15.0 | 24.0 | 2090 | 1905 |

If dimensions and/or weights for this fitting are critical, please contact your AMERICAN customer service representative for assistance.

All center dimensions reflect the C153 standard minimum dimension.

*Based on performance testing per AWWA C153, AMERICAN can rate these fittings 350 psi. However, because of the more labor-intensive and labor-reliant assembly of the MJ joint and the substantial thrust restraint requirements for working pressures that high, we recommend push-on joint configurations (Fastite, Flex-Ring and Lok-Ring) for high pressure applications.



AMERICAN Ductile Iron Mechanical Joint Fittings

ANSI/AWWA C110/A21.10 and C153/A21.53 22½° Bends (1/16th)

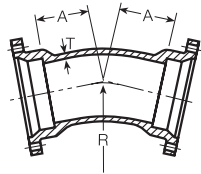

MJ and MJ

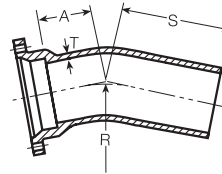

MJ and PE

Table No. 5-7 AWWA C110

| Size in. | Pressure Rating psi | Dimensions in Inches | | | | Weight in Pounds | |
|----------|---------------------|----------------------|------|------|--------|------------------|---------|
| | | T | A | S | R | MJ & MJ | MJ & PE |
| 4 | 350 | .52 | 4.0 | 12.0 | 10.06 | 50 | 45 |
| 6 | 350 | .55 | 5.0 | 13.0 | 15.06 | 75 | 70 |
| 8 | 350 | .60 | 5.5 | 13.5 | 17.62 | 110 | 105 |
| 10 | 350 | .68 | 6.5 | 14.5 | 22.62 | 160 | 160 |
| 12 | 350 | .75 | 7.5 | 15.5 | 27.62 | 220 | 220 |
| 14 | 350 | .66 | 7.5 | 15.5 | 25.12 | 275 | - |
| 16 | 350 | .70 | 8.0 | 16.0 | 27.62 | 345 | 325 |
| 18 | 350 | .75 | 8.5 | 16.5 | 30.19 | 430 | 405 |
| 20 | 350 | .80 | 9.5 | 17.5 | 35.19 | 535 | 505 |
| 24 | 350 | .89 | 11.0 | 19.0 | 37.69 | 765 | 725 |
| 30 | 250 | 1.03 | 15.0 | 23.0 | 57.81 | 1400 | 1295 |
| 36 | 250 | 1.15 | 18.0 | 26.0 | 72.88 | 2135 | 1970 |
| 42 | 250 | 1.28 | 21.0 | 29.0 | 88.00 | 3020 | 2810 |
| 48 | 250 | 1.42 | 24.0 | 32.0 | 103.06 | 4170 | - |

If dimensions and/or weights for this fitting are critical, please contact your AMERICAN customer service representative for assistance.

All center dimensions meet the C153 standard minimum dimension.

Table No. 5-8 AWWA C153 - Compact

| Size in. | Pressure Rating psi | Dimensions in Inches | | | Weight in Pounds | |
|----------|---------------------|----------------------|--------|--------|------------------|---------|
| | | T nom. | A min. | S min. | MJ & MJ | MJ & PE |
| 4 | 350 | .34 | 1.5 | 7.0 | 18 | 18 |
| 6 | 350 | .36 | 2.0 | 7.5 | 31 | 29 |
| 8 | 350 | .38 | 2.5 | 8.0 | 46 | 43 |
| 10 | 350 | .40 | 3.0 | 8.5 | 64 | 61 |
| 12 | 350 | .42 | 3.5 | 9.0 | 80 | 79 |
| 14 | 350 | .47 | 3.75 | 11.25 | 136 | 133 |
| 16 | 350 | .50 | 3.75 | 11.75 | 172 | 166 |
| 18 | 350 | .54 | 4.5 | 13.0 | 255 | 235 |
| 20 | 350 | .57 | 4.5 | 14.0 | 310 | 300 |
| 24 | 350 | .61 | 4.5 | 14.5 | 412 | 395 |
| 30 | 250* | .66 | 6.75 | 15.75 | 665 | 600 |
| 36 | 250* | .74 | 7.75 | 16.75 | 960 | 865 |
| 42 | 250* | .82 | 9.0 | 18.0 | 1350 | 1200 |
| 48 | 250* | .90 | 10.0 | 19.0 | 1760 | 1575 |

If dimensions and/or weights for this fitting are critical, please contact your AMERICAN customer service representative for assistance.

All center dimensions reflect the C153 standard minimum dimension.

*Based on performance testing per AWWA C153, AMERICAN can rate these fittings 350 psi. However, because of the more labor-intensive and labor-reliant assembly of the MJ joint and the substantial thrust restraint requirements for working pressures that high, we recommend push-on joint configurations (Fastite, Flex-Ring and Lok-Ring) for high pressure applications.



AMERICAN Ductile Iron Mechanical Joint Fittings

ANSI/AWWA C110/A21.10 and C153/A21.53 11¼° Bends (1/32nd)

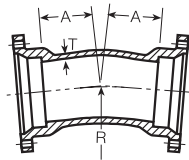

MJ and MJ

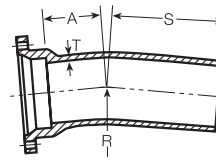

MJ and PE

Table No. 5-9 AWWA C110

| Size in. | Pressure Rating psi | Dimensions in Inches | | | | Weight in Pounds | |
|----------|---------------------|----------------------|------|------|--------|------------------|---------|
| | | T | A | S | R | MJ & MJ | MJ & PE |
| 4 | 350 | .52 | 4.0 | 12.0 | 20.31 | 50 | 45 |
| 6 | 350 | .55 | 5.0 | 13.0 | 30.50 | 75 | 70 |
| 8 | 350 | .60 | 5.5 | 13.5 | 35.50 | 110 | 105 |
| 10 | 350 | .68 | 6.5 | 14.5 | 45.69 | 160 | 160 |
| 12 | 350 | .75 | 7.5 | 15.5 | 55.81 | 220 | 220 |
| 14 | 350 | .66 | 7.5 | 15.5 | 50.75 | 275 | 260 |
| 16 | 350 | .70 | 8.0 | 16.0 | 55.81 | 345 | 325 |
| 18 | 350 | .75 | 8.5 | 16.5 | 60.94 | 430 | 405 |
| 20 | 350 | .80 | 9.5 | 17.5 | 71.06 | 540 | 510 |
| 24 | 350 | .89 | 11.0 | 19.0 | 76.12 | 770 | 730 |
| 30 | 250 | 1.03 | 15.0 | 23.0 | 116.75 | 1410 | 1305 |
| 36 | 250 | 1.15 | 18.0 | 26.0 | 147.25 | 2145 | 1980 |
| 42 | 250 | 1.28 | 21.0 | 29.0 | 177.69 | 3035 | - |
| 48 | 250 | 1.42 | 24.0 | 32.0 | 208.12 | 4190 | 3925 |

If dimensions and/or weights for this fitting are critical, please contact your AMERICAN customer service representative for assistance.

All center dimensions meet the C153 standard minimum dimension.

Table No. 5-10 AWWA C153 - Compact

| Size in. | Pressure Rating psi | Dimensions in Inches | | | Weight in Pounds | |
|----------|---------------------|----------------------|--------|--------|------------------|---------|
| | | T nom. | A min. | S min. | MJ & MJ | MJ & PE |
| 4 | 350 | .34 | 1.25 | 6.25 | 16 | 17 |
| 6 | 350 | .36 | 1.5 | 7.0 | 30 | 27 |
| 8 | 350 | .38 | 1.75 | 7.25 | 42 | 39 |
| 10 | 350 | .40 | 2.0 | 7.5 | 58 | 52 |
| 12 | 350 | .42 | 2.25 | 7.75 | 67 | 69 |
| 14 | 350 | .47 | 2.5 | 10.5 | 93 | 118 |
| 16 | 350 | .50 | 2.5 | 10.5 | 148 | 136 |
| 18 | 350 | .54 | 3.0 | 13.0 | 205 | 235 |
| 20 | 350 | .57 | 3.0 | 14.0 | 245 | 300 |
| 24 | 350 | .61 | 3.0 | 14.5 | 315 | 400 |
| 30 | 250* | .66 | 4.75 | 13.75 | 600 | 535 |
| 36 | 250* | .74 | 5.0 | 14.0 | 820 | 725 |
| 42 | 250* | .82 | 6.0 | 15.0 | 1180 | 1030 |
| 48 | 250* | .90 | 6.5 | 15.5 | 1475 | 1290 |

If dimensions and/or weights for this fitting are critical, please contact your AMERICAN customer service representative for assistance.

All center dimensions reflect the C153 standard minimum dimension.

*Based on performance testing per AWWA C153, AMERICAN can rate these fittings 350 psi. However, because of the more labor-intensive and labor-reliant assembly of the MJ joint and the substantial thrust restraint requirements for working pressures that high, we recommend push-on joint configurations (Fastite, Flex-Ring and Lok-Ring) for high pressure applications.

See General Notes on page 5-2.



AMERICAN Ductile Iron Mechanical Joint Fittings

ANSI/AWWA C110/A21.10 Tees and Crosses

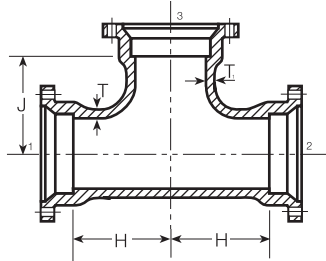

All MJ Tee

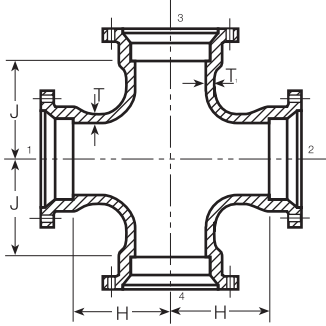

All MJ Cross

Table No. 5-11

| Size in. | | Pressure Rating psi | Dimensions in Inches | | | | | Weight in Pounds | |
|----------|--------|------------------------|----------------------|----------------|------|------|------|------------------|--------------|
| Run | Branch | | T | T ₁ | H | J | S | All MJ Tee | All MJ Cross |
| 4 | 4 | 350 | .52 | .52 | 6.5 | 6.5 | 14.5 | 80 | 105 |
| 6 | 4 | 350 | .55 | .52 | 8.0 | 8.0 | 16.0 | 115 | 140 |
| 6 | 6 | 350 | .55 | .55 | 8.0 | 8.0 | 16.0 | 125 | 160 |
| 8 | 4 | 350 | .60 | .52 | 9.0 | 9.0 | 17.0 | 165 | 185 |
| 8 | 6 | 350 | .60 | .55 | 9.0 | 9.0 | 17.0 | 175 | 205 |
| 8 | 8 | 350 | .60 | .60 | 9.0 | 9.0 | 17.0 | 185 | 235 |
| 10 | 4 | 350 | .68 | .52 | 11.0 | 11.0 | 19.0 | 235 | 260 |
| 10 | 6 | 350 | .68 | .55 | 11.0 | 11.0 | 19.0 | 250 | 285 |
| 10 | 8 | 350 | .68 | .60 | 11.0 | 11.0 | 19.0 | 260 | 310 |
| 10 | 10 | 350 | .80 | .80 | 11.0 | 11.0 | 19.0 | 310 | 380 |
| 12 | 4 | 350 | .75 | .52 | 12.0 | 12.0 | 20.0 | 315 | 340 |
| 12 | 6 | 350 | .75 | .55 | 12.0 | 12.0 | 20.0 | 325 | 360 |
| 12 | 8 | 350 | .75 | .60 | 12.0 | 12.0 | 20.0 | 340 | 385 |
| 12 | 10 | 350 | .87 | .80 | 12.0 | 12.0 | 20.0 | 390 | 460 |
| 12 | 12 | 350 | .87 | .87 | 12.0 | 12.0 | 20.0 | 410 | 495 |

If dimensions and/or weights for this fitting are critical, please contact your AMERICAN customer service representative for assistance.
All center dimensions meet the C153 standard minimum dimension.



AMERICAN Ductile Iron Mechanical Joint Fittings

**ANSI/AWWA C110/A21.10
Tees and Crosses**

Table No. 5-11—Continued

| Size in. | | Pressure Rating psi | Dimensions in Inches | | | | | Weight in Pounds | |
|----------|--------|------------------------|----------------------|----------------|------|------|------|------------------|--------|
| Run | Branch | | T | T ₁ | H | J | S | Tea | Cross |
| | | | | | | | | All MJ | All MJ |
| *14 | 4 | 350 | .66 | .52 | 14.0 | 14.0 | 22.0 | 420 | 450 |
| 14 | 6 | 350 | .66 | .55 | 14.0 | 14.0 | 22.0 | 435 | 475 |
| 14 | 8 | 350 | .66 | .60 | 14.0 | 14.0 | 22.0 | 450 | 500 |
| 14 | 10 | 350 | .66 | .68 | 14.0 | 14.0 | 22.0 | 465 | 540 |
| 14 | 12 | 350 | .66 | .75 | 14.0 | 14.0 | 22.0 | 495 | 585 |
| 14 | 14 | 350 | .66 | .66 | 14.0 | 14.0 | 22.0 | 520 | 635 |
| *16 | 4 | 350 | .70 | .52 | 15.0 | 15.0 | 23.0 | 525 | 555 |
| 16 | 6 | 350 | .70 | .55 | 15.0 | 15.0 | 23.0 | 540 | 575 |
| 16 | 8 | 350 | .70 | .60 | 15.0 | 15.0 | 23.0 | 550 | 605 |
| 16 | 10 | 350 | .70 | .68 | 15.0 | 15.0 | 23.0 | 570 | 645 |
| 16 | 12 | 350 | .70 | .75 | 15.0 | 15.0 | 23.0 | 590 | 685 |
| 16 | 14 | 350 | .70 | .66 | 15.0 | 15.0 | 23.0 | 620 | 735 |
| 16 | 16 | 350 | .70 | .70 | 15.0 | 15.0 | 23.0 | 650 | 790 |
| 18 | 6 | 350 | .75 | .55 | 13.0 | 15.5 | 21.0 | 590 | 625 |
| 18 | 8 | 350 | .75 | .60 | 13.0 | 15.5 | 21.0 | 605 | 655 |
| 18 | 10 | 350 | .75 | .68 | 13.0 | 15.5 | 21.0 | 620 | 685 |
| 18 | 12 | 350 | .75 | .75 | 13.0 | 15.5 | 21.0 | 640 | 725 |
| 18 | 14 | 350 | .75 | .66 | 16.5 | 16.5 | 24.5 | 755 | 870 |
| 18 | 16 | 350 | .75 | .70 | 16.5 | 16.5 | 24.5 | 785 | 930 |
| 18 | 18 | 350 | .75 | .75 | 16.5 | 16.5 | 24.5 | 820 | 995 |
| 20 | 6 | 350 | .80 | .55 | 14.0 | 17.0 | 22.0 | 725 | 760 |
| 20 | 8 | 350 | .80 | .60 | 14.0 | 17.0 | 22.0 | 735 | 790 |
| 20 | 10 | 350 | .80 | .68 | 14.0 | 17.0 | 22.0 | 755 | 820 |
| 20 | 12 | 350 | .80 | .75 | 14.0 | 17.0 | 22.0 | 775 | 860 |
| 20 | 14 | 350 | .80 | .66 | 14.0 | 17.0 | 22.0 | 795 | 905 |
| 20 | 16 | 350 | .80 | .70 | 18.0 | 18.0 | 26.0 | 945 | 1085 |
| 20 | 18 | 350 | .80 | .75 | 18.0 | 18.0 | 26.0 | 985 | 1155 |
| 20 | 20 | 350 | .80 | .80 | 18.0 | 18.0 | 26.0 | 1020 | 1230 |
| 24 | 6 | 350 | .89 | .55 | 15.0 | 19.0 | 23.0 | 985 | 1025 |
| 24 | 8 | 350 | .89 | .60 | 15.0 | 19.0 | 23.0 | 1000 | 1045 |
| 24 | 10 | 350 | .89 | .68 | 15.0 | 19.0 | 23.0 | 1020 | 1085 |
| 24 | 12 | 350 | .89 | .75 | 15.0 | 19.0 | 23.0 | 1030 | 1110 |
| 24 | 14 | 350 | .89 | .66 | 15.0 | 19.0 | 23.0 | 1055 | 1155 |
| 24 | 16 | 350 | .89 | .70 | 15.0 | 19.0 | 23.0 | 1075 | 1200 |
| 24 | 18 | 350 | .89 | .75 | 22.0 | 22.0 | 30.0 | 1400 | 1590 |
| 24 | 20 | 350 | .89 | .80 | 22.0 | 22.0 | 30.0 | 1450 | 1675 |
| 24 | 24 | 350 | .89 | .89 | 22.0 | 22.0 | 30.0 | 1535 | 1835 |
| 30 | 6 | 250 | 1.03 | .55 | 18.0 | 23.0 | 26.0 | 1730 | 1770 |
| 30 | 8 | 250 | 1.03 | .60 | 18.0 | 23.0 | 26.0 | 1745 | 1795 |
| 30 | 10 | 250 | 1.03 | .68 | 18.0 | 23.0 | 26.0 | 1760 | 1830 |
| 30 | 12 | 250 | 1.03 | .75 | 18.0 | 23.0 | 26.0 | 1780 | 1865 |
| 30 | 14 | 250 | 1.03 | .66 | 18.0 | 23.0 | 26.0 | 1800 | 1905 |
| 30 | 16 | 250 | 1.03 | .70 | 18.0 | 23.0 | 26.0 | 1820 | 1950 |
| 30 | 18 | 250 | 1.03 | .75 | 18.0 | 23.0 | 26.0 | 1845 | 2000 |
| 30 | 20 | 250 | 1.03 | .80 | 18.0 | 23.0 | 26.0 | 1875 | 2060 |
| 30 | 24 | 250 | 1.03 | .89 | 25.0 | 25.0 | 33.0 | 2400 | 2675 |
| 30 | 30 | 250 | 1.03 | 1.03 | 25.0 | 25.0 | 33.0 | 2595 | 3075 |

If dimensions and/or weights for this fitting are critical, please contact your AMERICAN customer service representative for assistance.
All center dimensions reflect the C153 standard minimum dimension.



AMERICAN Ductile Iron Mechanical Joint Fittings

**ANSI/AWWA C110/A21.10
Tees and Crosses**

Table No. 5-11—Continued

| Size in. | | Pressure Rating psi | Dimensions in Inches | | | | | Weight in Pounds | |
|----------|--------|------------------------|----------------------|----------------|------|------|------|------------------|-----------------|
| Run | Branch | | T | T ₁ | H | J | S | Tee All MJ | Cross All MJ |
| 36 | 12 | 250 | 1.15 | .75 | 20.0 | 26.0 | 28.0 | 2550 | 2630 |
| 36 | 14 | 250 | 1.15 | .66 | 20.0 | 26.0 | 28.0 | 2570 | 2665 |
| 36 | 16 | 250 | 1.15 | .70 | 20.0 | 26.0 | 28.0 | 2585 | 2705 |
| 36 | 18 | 250 | 1.15 | .75 | 20.0 | 26.0 | 28.0 | 2610 | 2750 |
| 36 | 20 | 250 | 1.15 | .80 | 20.0 | 26.0 | 28.0 | 2635 | 2805 |
| 36 | 24 | 250 | 1.15 | .89 | 20.0 | 26.0 | 28.0 | 2690 | 2910 |
| 36 | 30 | 250 | 1.15 | 1.03 | 28.0 | 28.0 | 36.0 | 3545 | 3965 |
| 36 | 36 | 250 | 1.15 | 1.15 | 28.0 | 28.0 | 36.0 | 3745 | 4370 |
| 42 | 24 | 250 | 1.28 | .89 | 23.0 | 30.0 | 31.0 | 3690 | 3910 |
| 42 | 30 | 250 | 1.28 | 1.03 | 31.0 | 31.0 | 39.0 | 4650 | 5040 |
| 42 | 36 | 250 | 1.78 | 1.58 | 31.0 | 31.0 | 39.0 | 6075 | 6655 |
| 42 | 42 | 250 | 1.78 | 1.78 | 31.0 | 31.0 | 39.0 | 6320 | 7145 |
| 48 | 24 | 250 | 1.42 | .89 | 26.0 | 34.0 | 34.0 | 4995 | 5210 |
| 48 | 30 | 250 | 1.42 | 1.03 | 26.0 | 34.0 | 34.0 | 5140 | 5495 |
| 48 | 36 | 250 | 1.42 | 1.15 | 34.0 | 34.0 | 42.0 | 6280 | 6790 |
| 48 | 42 | 250 | 1.96 | 1.78 | 34.0 | 34.0 | 42.0 | 8130 | 8815 |
| 48 | 48 | 250 | 1.96 | 1.96 | 34.0 | 34.0 | 42.0 | 8420 | 9380 |

If dimensions and/or weights for this fitting are critical, please contact your AMERICAN customer service representative for assistance.

All center dimensions meet the C153 standard minimum dimension.

Note: Welded-on outlets may be preferable to tees and crosses in many cases from a layout, installation and economical standpoint. See Section 7.



AMERICAN Ductile Iron Mechanical Joint Fittings
ANSI/AWWA C153/A21.53
Compact Tees and Crosses

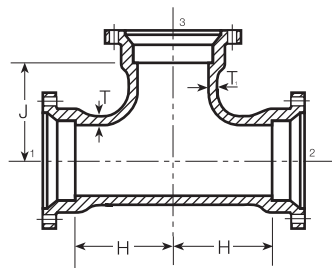

All MJ Tee

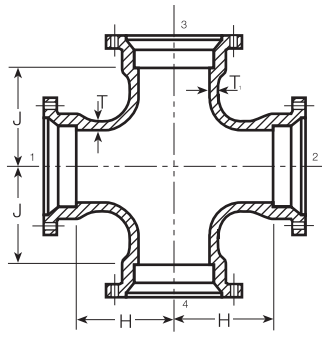

All MJ Cross

Table No. 5-12

| Size in. | | Pressure Rating psi | Dimensions in Inches | | | | Weight in Pounds | |
|----------|--------|------------------------|----------------------|---------------------|--------|--------|------------------|-----------------|
| Run | Branch | | T nom. | T ₁ nom. | H min. | J min. | Tee All MJ | Cross All MJ |
| 4 | 4 | 350 | .34 | .34 | 4.0 | 4.0 | 32 | 40 |
| 6 | 4 | 350 | .36 | .34 | 4.0 | 5.0 | 46 | 68 |
| 6 | 6 | 350 | .36 | .36 | 5.0 | 5.0 | 56 | 75 |
| 8 | 4 | 350 | .38 | .34 | 4.0 | 6.5 | 60 | 99 |
| 8 | 6 | 350 | .38 | .36 | 5.0 | 6.5 | 72 | 108 |
| 8 | 8 | 350 | .38 | .38 | 6.5 | 6.5 | 86 | 105 |
| 10 | 4 | 350 | .40 | .34 | 4.0 | 7.5 | 78 | 98 |
| 10 | 6 | 350 | .40 | .36 | 5.0 | 7.5 | 90 | 118 |
| 10 | 8 | 350 | .40 | .38 | 6.5 | 7.5 | 105 | 138 |
| 10 | 10 | 350 | .40 | .40 | 7.5 | 7.5 | 120 | 145 |
| 12 | 4 | 350 | .42 | .34 | 4.0 | 8.75 | 94 | 100 |
| 12 | 6 | 350 | .42 | .36 | 5.0 | 8.75 | 110 | 140 |
| 12 | 8 | 350 | .42 | .38 | 6.5 | 8.75 | 125 | 162 |
| 12 | 10 | 350 | .42 | .40 | 7.5 | 8.75 | 140 | 190 |
| 12 | 12 | 350 | .42 | .42 | 8.75 | 8.75 | 160 | 213 |
| 14 | 4 | 350 | .47 | .34 | 5.5 | 10.5 | 172 | 162 |
| 14 | 6 | 350 | .47 | .36 | 6.5 | 10.5 | 182 | 181 |
| 14 | 8 | 350 | .47 | .38 | 7.5 | 10.5 | 206 | 259 |
| 14 | 10 | 350 | .47 | .40 | 8.5 | 10.5 | 228 | 223 |
| 14 | 12 | 350 | .47 | .42 | 9.5 | 10.5 | 234 | 244 |
| 14 | 14 | 350 | .47 | .47 | 10.5 | 10.5 | 280 | 299 |
| 16 | 6 | 350 | .50 | .36 | 6.5 | 11.5 | 228 | 250 |
| 16 | 8 | 350 | .50 | .38 | 7.5 | 11.5 | 248 | 289 |
| 16 | 10 | 350 | .50 | .40 | 8.5 | 11.5 | 264 | 345 |
| 16 | 12 | 350 | .50 | .42 | 9.5 | 11.5 | 280 | 397 |
| 16 | 14 | 350 | .50 | .47 | 10.5 | 11.5 | 316 | 333 |
| 16 | 16 | 350 | .50 | .50 | 11.5 | 11.5 | 322 | 385 |

If dimensions and/or weights for this fitting are critical, please contact your AMERICAN customer service representative for assistance.

All center dimensions reflect the C153 standard minimum dimension.

Numerals on cuts indicate standard order of specifying size and joint type of fitting.

See Section 6 for reducing tees, tees reducing on run and branch, and bullhead tees.



**AMERICAN Ductile Iron Mechanical Joint Fittings
ANSI/AWWA C153/A21.53
Compact Tees and Crosses**

Table No. 5-12—Continued

| Size in. | | Pressure Rating psi | Dimensions in Inches | | | | Weight in Pounds | |
|----------|--------|---------------------|----------------------|---------------------|--------|--------|------------------|--------------|
| Run | Branch | | T nom. | T ₁ nom. | H min. | J min. | Tee All MJ | Cross All MJ |
| 18 | 6 | 350 | .54 | .36 | 6.5 | 12.5 | 275 | 260 |
| 18 | 8 | 350 | .54 | .38 | 7.5 | 12.5 | 295 | 282 |
| 18 | 10 | 350 | .54 | .40 | 8.5 | 12.5 | 315 | 308 |
| 18 | 12 | 350 | .54 | .42 | 9.5 | 12.5 | 335 | — |
| 18 | 14 | 350 | .54 | .47 | 10.5 | 12.5 | 380 | 384 |
| 18 | 16 | 350 | .54 | .50 | 11.5 | 12.5 | 405 | — |
| 18 | 18 | 350 | .54 | .54 | 12.5 | 12.5 | 435 | 630 |
| 20 | 6 | 350 | .57 | .36 | 6.5 | 14.0 | 315 | 306 |
| 20 | 8 | 350 | .57 | .38 | 8.0 | 14.0 | 345 | 341 |
| 20 | 10 | 350 | .57 | .40 | 9.0 | 14.0 | 370 | 370 |
| 20 | 12 | 350 | .57 | .42 | 10.0 | 14.0 | 395 | 392 |
| 20 | 14 | 350 | .57 | .47 | 11.0 | 14.0 | 440 | 451 |
| 20 | 16 | 350 | .57 | .50 | 12.0 | 14.0 | 465 | 634 |
| 20 | 18 | 350 | .57 | .54 | 13.0 | 14.0 | 505 | 547 |
| 20 | 20 | 350 | .57 | .57 | 14.0 | 14.0 | 535 | 605 |
| 24 | 6 | 350 | .61 | .36 | 13.0 | 17.0 | 415 | 403 |
| 24 | 8 | 350 | .61 | .38 | 13.0 | 17.0 | 445 | 431 |
| 24 | 10 | 350 | .61 | .40 | 13.0 | 17.0 | 470 | 465 |
| 24 | 12 | 350 | .61 | .42 | 13.0 | 17.0 | 500 | 494 |
| 24 | 14 | 350 | .61 | .47 | 13.0 | 17.0 | 550 | 553 |
| 24 | 16 | 350 | .61 | .50 | 13.0 | 17.0 | 580 | 714 |
| 24 | 18 | 350 | .61 | .54 | 17.0 | 17.0 | 625 | — |
| 24 | 20 | 350 | .61 | .57 | 17.0 | 17.0 | 660 | 809 |
| 24 | 24 | 350 | .61 | .61 | 17.0 | 17.0 | 720 | 830 |
| 30 | 20 | 250* | .66 | .57 | 16.5 | 21.0 | 995 | 991 |
| 30 | 24 | 250* | .66 | .61 | 22.0 | 22.0 | 1060 | 1083 |
| 30 | 30 | 250* | .66 | .66 | 22.0 | 22.0 | 1323 | 1840 |
| 36 | 24 | 250* | .74 | .61 | 18.5 | 26.0 | 1498 | — |
| 36 | 30 | 250* | .74 | .66 | 26.0 | 26.0 | 1555 | — |
| 36 | 36 | 250* | .74 | .74 | 26.0 | 26.0 | 1900 | 2655 |
| 42 | 24 | 250* | .82 | .61 | 22.0 | 27.5 | 2270 | 2055 |
| 42 | 30 | 250* | .82 | .66 | 22.0 | 29.5 | 2425 | 2950 |
| 42 | 36 | 250* | .82 | .74 | 30.0 | 30.0 | 3000 | 3955 |
| 42 | 42 | 250* | .82 | .82 | 30.0 | 30.0 | 3175 | 3725 |
| 48 | 24 | 250* | .90 | .61 | 23.0 | 32.0 | 2870 | 2766 |
| 48 | 30 | 250* | .90 | .66 | 23.0 | 32.0 | 3050 | 4500 |
| 48 | 36 | 250* | .90 | .74 | 33.5 | 32.25 | 3900 | 3719 |
| 48 | 42 | 250* | .90 | .82 | 33.5 | 33.5 | 4100 | 4590 |
| 48 | 48 | 250* | .90 | .90 | 33.5 | 33.5 | 4250 | 4955 |

If dimensions and/or weights for this fitting are critical, please contact your AMERICAN customer service representative for assistance.

All center dimensions reflect the C153 standard minimum dimension.

See General Notes on page 5-2.

* Based on performance testing per AWWA C153, AMERICAN can rate these fittings 350 psi. However, because of the more labor-intensive and labor-reliant assembly of the MJ joint and the substantial thrust restraint requirements for working pressures that high, we recommend push-on joint configurations (Fastite, Flex-Ring and Lok-Ring) for high-pressure applications.



AMERICAN Ductile Iron Mechanical Joint Fittings

ANSI/AWWA C110/A21.10 Reducers

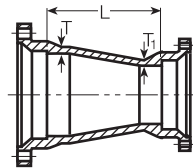

MJ and MJ Reducer

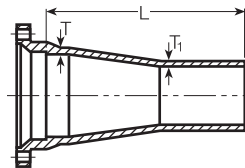

Large End MJ Reducer

Table No. 5-13

| Size in. | | Pressure Rating psi | Thickness in. | | MJ & MJ | | Large End MJ | |
|-----------|-----------|---------------------|---------------|--------------|---------|------------|--------------|------------|
| Large End | Small End | | T Large End | T1 Small End | L in | Weight lb. | L in | Weight lb. |
| 6 | 4 | 350 | .55 | .52 | 9 | 60 | 17 | 60 |
| 8 | 4 | 350 | .60 | .52 | 11 | 80 | 19 | 80 |
| 8 | 6 | 350 | .60 | .55 | 11 | 95 | 19 | 90 |
| 10 | 4 | 350 | .68 | .52 | 12 | 105 | 20 | 100 |
| 10 | 6 | 350 | .68 | .55 | 12 | 115 | 20 | 115 |
| 10 | 8 | 350 | .68 | .60 | 12 | 135 | 20 | 130 |
| 12 | 4 | 350 | .75 | .52 | 14 | 135 | 22 | 130 |
| 12 | 6 | 350 | .75 | .55 | 14 | 150 | 22 | 145 |
| 12 | 8 | 350 | .75 | .60 | 14 | 165 | 22 | 165 |
| 12 | 10 | 350 | .75 | .68 | 14 | 190 | 22 | 185 |
| 14 | 6 | 350 | .66 | .55 | 16 | 190 | 24 | 185 |
| 14 | 8 | 350 | .66 | .60 | 16 | 210 | 24 | 205 |
| 14 | 10 | 350 | .66 | .68 | 16 | 230 | - | - |
| 14 | 12 | 350 | .66 | .75 | 16 | 255 | 24 | 255 |
| 16 | 6 | 350 | .70 | .55 | 18 | 230 | 26 | 230 |
| 16 | 8 | 350 | .70 | .60 | 18 | 250 | 26 | 250 |
| 16 | 10 | 350 | .70 | .68 | 18 | 280 | 26 | 275 |
| 16 | 12 | 350 | .70 | .75 | 18 | 305 | 26 | 305 |
| 16 | 14 | 350 | .70 | .66 | 18 | 335 | 26 | 315 |
| 18 | 8 | 350 | .75 | .60 | 19 | 295 | 27 | 295 |
| 18 | 10 | 350 | .75 | .68 | 19 | 325 | 27 | 320 |
| 18 | 12 | 350 | .75 | .75 | 19 | 350 | 27 | 350 |
| 18 | 14 | 350 | .75 | .66 | 19 | 380 | 27 | 365 |
| 18 | 16 | 350 | .75 | .70 | 19 | 415 | 27 | 395 |

If dimensions and/or weights for this fitting are critical, please contact your AMERICAN customer service representative for assistance.
All center dimensions meet the C153 standard minimum dimension.



AMERICAN Ductile Iron Mechanical Joint Fittings

**ANSI/AWWA C110/A21.10
Reducers**

Table No. 5-13—Continued

| Size in. | | Pressure Rating psi | Thickness in. | | MJ & MJ | | Large End MJ | |
|-----------|-----------|---------------------|---------------|--------------|---------|-----------|--------------|-----------|
| Large End | Small End | | T Large End | T1 Small End | L in. | Weight lb | L in. | Weight lb |
| **20 | 6 | 350 | .80 | .55 | 20 | 320 | — | — |
| **20 | 8 | 350 | .80 | .60 | 20 | 360 | — | — |
| 20 | 10 | 350 | .80 | .68 | 20 | 375 | 28 | 375 |
| 20 | 12 | 350 | .80 | .75 | 20 | 405 | 28 | 405 |
| 20 | 14 | 350 | .80 | .66 | 20 | 430 | 28 | 415 |
| 20 | 16 | 350 | .80 | .70 | 20 | 470 | 28 | 445 |
| 20 | 18 | 350 | .80 | .75 | 20 | 510 | 28 | 485 |
| **24 | 8 | 350 | .89 | .60 | 24 | 475 | — | — |
| **24 | 10 | 350 | .89 | .68 | 24 | 510 | — | — |
| 24 | 12 | 350 | .89 | .75 | 24 | 550 | 32 | 550 |
| 24 | 14 | 350 | .89 | .66 | 24 | 575 | 32 | 560 |
| 24 | 16 | 350 | .89 | .70 | 24 | 615 | 32 | 595 |
| 24 | 18 | 350 | .89 | .75 | 24 | 660 | 32 | 635 |
| 24 | 20 | 350 | .89 | .80 | 24 | 705 | 32 | 675 |
| **30 | 12 | 250 | 1.03 | .75 | 30 | 865 | 38 | 875 |
| **30 | 16 | 250 | 1.03 | .70 | 30 | 940 | 38 | 920 |
| 30 | 18 | 250 | 1.03 | .75 | 30 | 990 | 38 | 965 |
| 30 | 20 | 250 | 1.03 | .80 | 30 | 1050 | 38 | 1020 |
| 30 | 24 | 250 | 1.03 | .89 | 30 | 1165 | 38 | 1125 |
| **36 | 14 | 250 | 1.15 | .66 | 36 | 1265 | — | — |
| **36 | 16 | 250 | 1.15 | .70 | 36 | 1320 | — | — |
| **36 | 18 | 250 | 1.15 | .75 | 36 | 1385 | — | — |
| 36 | 20 | 250 | 1.15 | .80 | 36 | 1450 | 44 | 1420 |
| 36 | 24 | 250 | 1.15 | .89 | 36 | 1580 | 44 | 1535 |
| 36 | 30 | 250 | 1.15 | 1.03 | 36 | 1855 | 44 | 1750 |
| 42 | 20 | 250 | 1.28 | .80 | 42 | 1915 | — | — |
| 42 | 24 | 250 | 1.28 | .89 | 42 | 2060 | — | — |
| 42 | 30 | 250 | 1.28 | 1.03 | 42 | 2370 | 50 | 2265 |
| 42 | 36 | 250 | 1.28 | 1.15 | 42 | 2695 | 50 | 2530 |
| 48 | 30 | 250 | 1.42 | 1.03 | 48 | 3005 | — | — |
| 48 | 36 | 250 | 1.42 | 1.15 | 48 | 3370 | — | — |
| 48 | 42 | 250 | 1.42 | 1.28 | 48 | 3750 | 56 | 3540 |

If dimensions and/or weights for this fitting are critical, please contact your AMERICAN customer service representative for assistance.

All center dimensions meet the C153 standard minimum dimension.

**Not included in AWWA C110.

Eccentric reducers are available in some of the above sizes; dimensions and weights are approximately the same as those shown for concentric reducers. Check availability of specified size of eccentric reducers as required.



AMERICAN Ductile Iron Mechanical Joint Fittings

ANSI/AWWA C153/A21.53 Compact Reducers

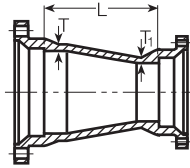

MJ and MJ Reducer

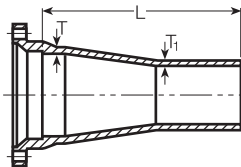

Large End MJ Reducer

Table No. 5-14

| Size in. | | Pressure Rating psi | Thickness in. | | MJ & MJ | | Large End MJ | |
|-----------|-----------|---------------------|-------------------|--------------------|-------------|-----------|--------------|-----------|
| Large End | Small End | | T Large End (nom) | T1 Small End (nom) | L in. (min) | Weight lb | L in. (min) | Weight lb |
| 6 | 4 | 350 | .36 | .34 | 4 | 32 | 9.5 | 22 |
| 8 | 4 | 350 | .38 | .34 | 5 | 43 | 10.5 | 29 |
| 8 | 6 | 350 | .38 | .36 | 4 | 54 | 9.5 | 32 |
| 10 | 4 | 350 | .40 | .34 | 7 | 61 | 12.5 | 40 |
| 10 | 6 | 350 | .40 | .36 | 5 | 64 | 10.5 | 42 |
| 10 | 8 | 350 | .40 | .38 | 4 | 62 | 9.5 | 45 |
| 12 | 4 | 350 | .42 | .34 | 9 | 82 | 14.5 | 52 |
| 12 | 6 | 350 | .42 | .36 | 7 | 85 | 12.5 | 53 |
| 12 | 8 | 350 | .42 | .38 | 5 | 82 | 10.5 | 55 |
| 12 | 10 | 350 | .42 | .40 | 4 | 82 | 9.5 | 57 |
| 14 | 6 | 350 | .47 | .36 | 9 | 108 | 14.5 | 112 |
| 14 | 8 | 350 | .47 | .38 | 7 | 104 | 12.4 | 108 |
| 14 | 10 | 350 | .47 | .40 | 5 | 100 | 10.4 | 100 |
| 14 | 12 | 350 | .47 | .42 | 4 | 100 | 9.4 | 100 |

If dimensions and/or weights for this fitting are critical, please contact your AMERICAN customer service representative for assistance.
All center dimensions reflect the C153 standard minimum dimension.



AMERICAN Ductile Iron Mechanical Joint Fittings

**ANSI/AWWA C153/A21.53
Compact Reducers**

Table No. 5-14–Continued

| Size in. | | Pressure Rating psi | MJ & MJ | | Large End MJ | |
|-----------|-----------|---------------------|-------------|-----------|--------------|-----------|
| Large End | Small End | | L in. (min) | Weight lb | L in. (min) | Weight lb |
| 16 | 6 | 350 | 11.0 | 136 | 16.5 | 144 |
| 16 | 8 | 350 | 9.0 | 132 | 14.4 | 136 |
| 16 | 10 | 350 | 7.0 | 128 | 12.5 | 128 |
| 16 | 12 | 350 | 5.0 | 125 | 10.5 | 119 |
| 16 | 14 | 350 | 4.0 | 140 | 12.0 | 138 |
| 18 | 4 | – | 11.0 | 170 | – | – |
| 18 | 8 | 350 | 13.0 | 194 | 19.5 | 195 |
| 18 | 10 | 350 | 10.0 | 196 | 17.4 | 190 |
| 18 | 12 | 350 | 7.0 | 185 | 14.0 | 190 |
| 18 | 14 | 350 | 6.0 | 190 | 15.0 | 190 |
| 18 | 16 | 350 | 5.0 | 196 | 12.5 | 210 |
| 20 | 6 | – | 16.0 | 232 | – | – |
| 20 | 8 | – | 16.0 | 227 | – | – |
| 20 | 10 | 350 | 14.0 | 225 | 19.0 | 210 |
| 20 | 12 | 350 | 12.0 | 210 | 16.0 | 205 |
| 20 | 14 | 350 | 10.0 | 208 | 17.9 | 220 |
| 20 | 16 | 350 | 7.0 | 225 | 13.5 | 290 |
| 20 | 18 | 350 | 4.0 | 233 | 12.0 | 335 |
| 24 | 8 | – | 16.0 | 318 | – | – |
| 24 | 10 | – | 16.0 | 312 | – | – |
| 24 | 12 | 350 | 16.0 | 310 | 21.0 | 290 |
| 24 | 14 | 350 | 14.0 | 315 | 21.9 | 335 |
| 24 | 16 | 350 | 12.0 | 324 | 17.5 | 310 |
| 24 | 18 | 350 | 10.0 | 312 | 18.0 | 315 |
| 24 | 20 | 350 | 7.0 | 315 | 13.5 | 307 |
| 30 | 12 | 250 | 30.0 | 499 | – | – |
| 30 | 16 | 250 | 30.0 | 633 | 39.0 | 623 |
| 30 | 18 | 250 | 28.0 | 658 | 37.0 | 635 |
| 30 | 20 | 250 | 24.0 | 628 | 33.0 | 603 |
| 30 | 24 | 250 | 10.0 | 478 | 24.5 | 526 |
| 36 | 12 | 250 | 30.0 | 1058 | – | – |
| 36 | 16 | 250 | 30.0 | 1016 | – | – |
| 36 | 18 | 250 | 36.0 | 983 | – | – |
| 36 | 20 | 250 | 36.0 | 975 | 45.0 | 950 |
| 36 | 24 | 250 | 19.0 | 770 | 33.0 | 810 |
| 36 | 30 | 250 | 15.5 | 650 | 24.5 | 2758 |
| 42 | 20 | 250 | 40.0 | – | – | – |
| 42 | 24 | 250 | 40.0 | 1356 | 49.0 | 1319 |
| 42 | 30 | 250 | 20.0 | 1083 | 29.0 | 1015 |
| 42 | 36 | 250 | 15.5 | 1114 | 24.5 | 1013 |
| 48 | 20 | 250 | 40.0 | – | – | – |
| 48 | 24 | 250 | 40.0 | – | – | – |
| 48 | 30 | 250 | 40.0 | 1779 | 49.0 | 1711 |
| 48 | 36 | 250 | 28.0 | 1641 | 37.0 | 1540 |
| 48 | 42 | 250 | 15.5 | 1426 | 24.5 | 1274 |

If dimensions and/or weights for this fitting are critical, please contact your AMERICAN customer service representative for assistance.
All center dimensions reflect the C153 standard minimum dimension.



AMERICAN Ductile Iron Mechanical Joint Fittings

AMERICAN Standard Wyes

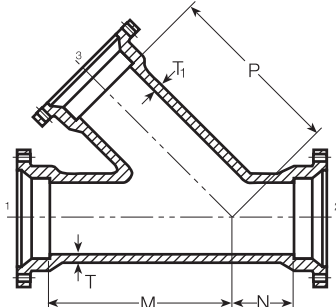

Table No. 5-15

| Size in. | | Pressure Rating* psi | Dimensions in Inches | | | | | | Weight in Pounds |
|----------|--------|-------------------------|----------------------|----------------|------|-----|------|---|------------------|
| Run | Branch | | T | T ₁ | M | N | P | S | |
| 4 | 4 | 350 | .52 | .52 | 12.0 | 3.0 | 12.0 | — | 95 |
| 6 | 4 | 350 | .55 | .52 | 14.5 | 3.5 | 14.5 | — | 135 |
| 6 | 6 | 350 | .55 | .55 | 14.5 | 3.5 | 14.5 | — | 150 |
| 8 | 4 | 350 | .60 | .52 | 17.5 | 4.5 | 17.5 | — | 190 |
| 8 | 6 | 350 | .60 | .55 | 17.5 | 4.5 | 17.5 | — | 205 |
| 8 | 8 | 350 | .60 | .60 | 17.5 | 4.5 | 17.5 | — | 225 |
| 10 | 4 | 350 | .68 | .52 | 20.5 | 5.0 | 20.5 | — | 270 |
| 10 | 6 | 350 | .68 | .55 | 20.5 | 5.0 | 20.5 | — | 285 |
| 10 | 8 | 350 | .68 | .60 | 20.5 | 5.0 | 20.5 | — | 305 |
| 10 | 10 | 350 | .68 | .68 | 20.5 | 5.0 | 20.5 | — | 375 |
| 12 | 4 | 350 | .75 | .52 | 24.5 | 5.5 | 24.5 | — | 380 |
| 12 | 6 | 350 | .75 | .55 | 24.5 | 5.5 | 24.5 | — | 390 |
| 12 | 8 | 350 | .75 | .60 | 24.5 | 5.5 | 24.5 | — | 415 |
| 12 | 10 | 350 | .75 | .68 | 24.5 | 5.5 | 24.5 | — | 500 |
| 12 | 12 | 350 | .75 | .75 | 24.5 | 5.5 | 24.5 | — | 535 |
| 14 | 6 | 350 | .66 | .55 | 27.0 | 6.0 | 27.0 | — | 565 |
| 14 | 8 | 350 | .66 | .60 | 27.0 | 6.0 | 27.0 | — | 595 |
| 14 | 10 | 350 | .66 | .68 | 27.0 | 6.0 | 27.0 | — | 630 |
| 14 | 12 | 350 | .66 | .75 | 27.0 | 6.0 | 27.0 | — | 690 |
| 14 | 14 | 350 | .66 | .66 | 27.0 | 6.0 | 27.0 | — | 700 |
| 16 | 6 | 350 | .70 | .55 | 30.0 | 6.5 | 30.0 | — | 755 |
| 16 | 8 | 350 | .70 | .60 | 30.0 | 6.5 | 30.0 | — | 790 |
| 16 | 10 | 350 | .70 | .68 | 30.0 | 6.5 | 30.0 | — | 850 |
| 16 | 12 | 350 | .70 | .75 | 30.0 | 6.5 | 30.0 | — | 905 |
| 16 | 14 | 350 | .70 | .66 | 30.0 | 6.5 | 30.0 | — | 865 |
| 16 | 16 | 350 | .70 | .70 | 30.0 | 6.5 | 30.0 | — | 890 |
| 18 | 6 | 350 | .75 | .55 | 25.0 | 1.0 | 27.5 | — | 960 |
| 18 | 8 | 350 | .75 | .60 | 25.0 | 1.0 | 27.5 | — | 1015 |
| 18 | 10 | 350 | .75 | .68 | 32.0 | 7.0 | 32.0 | — | 1070 |
| 18 | 12 | 350 | .75 | .75 | 32.0 | 7.0 | 32.0 | — | 1130 |
| 18 | 14 | 350 | .75 | .66 | 32.0 | 7.0 | 32.0 | — | 1115 |
| 18 | 16 | 350 | .75 | .70 | 32.0 | 7.0 | 32.0 | — | 1150 |
| 18 | 18 | 350 | .75 | .75 | 32.0 | 7.0 | 32.0 | — | 1190 |

If dimensions and/or weights for this fitting are critical, please contact your AMERICAN customer service representative for assistance.

Wye dimensions vary between manufacturers.

Numerals on cuts indicate standard order of specifying size of fitting.



AMERICAN Ductile Iron Mechanical Joint Fittings

AMERICAN Standard Wyes

Table No. 5-15—Continued

| Size in. | | Pressure Rating* psi | Dimensions in Inches | | | | | | Weight in Pounds All MJ |
|----------|--------|-------------------------|----------------------|----------------|------|-------|------|-------|----------------------------|
| Run | Branch | | T | T ₁ | M | N | P | S | |
| 20 | 4 | 350 | .80 | .52 | 27.0 | — | 29.5 | — | 1250 |
| 20 | 6 | 350 | .80 | .55 | 27.0 | — | 29.5 | — | 1300 |
| 20 | 8 | 350 | .80 | .60 | 27.0 | — | 29.5 | — | 1365 |
| 20 | 10 | 350 | .80 | .68 | 27.0 | 1.0 | 29.5 | — | 1435 |
| 20 | 12 | 350 | .80 | .75 | 35.0 | 8.0 | 35.0 | — | 540 |
| 20 | 14 | 350 | .80 | .66 | 35.0 | 8.0 | 35.0 | — | 565 |
| 20 | 16 | 350 | .80 | .70 | 35.0 | 8.0 | 35.0 | — | 595 |
| 20 | 18 | 350 | .80 | .75 | 35.0 | 8.0 | 35.0 | — | 630 |
| 20 | 20 | 350 | .80 | .80 | 35.0 | 8.0 | 35.0 | — | 690 |
| 24 | 6 | 350 | .89 | .55 | 31.5 | 0.5 | 31.5 | — | 953 |
| 24 | 8 | 350 | .89 | .60 | 31.5 | 0.0 | 34.5 | — | 1625 |
| 24 | 12 | 350 | .89 | .75 | 31.5 | 0.5 | 34.5 | — | 1700 |
| 24 | 14 | 350 | .89 | .66 | 40.5 | 9.0 | 40.5 | — | 1760 |
| 24 | 16 | 350 | .89 | .70 | 40.5 | 9.0 | 40.5 | — | 1815 |
| 24 | 18 | 350 | .89 | .75 | 40.5 | 9.0 | 40.5 | — | 1880 |
| 24 | 20 | 350 | .89 | .80 | 40.5 | 9.0 | 40.5 | — | 1950 |
| 24 | 24 | 350 | .89 | .89 | 40.5 | 9.0 | 40.5 | — | 2115 |
| 30 | 12 | 250 | 1.03 | .75 | 49.0 | 10.00 | 49.0 | 18.0 | 2850 |
| 30 | 16 | 250 | 1.03 | .70 | 49.0 | 10.00 | 49.0 | 18.0 | 2975 |
| 30 | 18 | 250 | 1.03 | .75 | 49.0 | 10.00 | 49.0 | 18.0 | 3040 |
| 30 | 20 | 250 | 1.03 | .80 | 80.0 | 10.00 | 49.0 | 18.0 | 3115 |
| 30 | 24 | 250 | 1.03 | .89 | 49.0 | 10.00 | 49.0 | 18.0 | 3280 |
| 30 | 30 | 250 | 1.03 | 1.03 | 52.5 | 18.25 | 52.5 | 26.25 | 3670 |
| 36 | 12 | 250 | 1.15 | .75 | 54.0 | 15.25 | 54.0 | — | 4895 |
| 36 | 14 | 250 | 1.15 | .66 | 54.0 | 15.25 | 54.0 | 23.25 | 4970 |
| 36 | 16 | 250 | 1.15 | .70 | 54.0 | 15.25 | 54.0 | 23.25 | 5040 |
| 36 | 18 | 250 | 1.15 | .75 | 54.0 | 15.25 | 54.0 | 23.25 | 5120 |
| 36 | 20 | 250 | 1.15 | .80 | 54.0 | 15.25 | 54.0 | 23.25 | 5205 |
| 36 | 24 | 250 | 1.15 | .89 | 54.0 | 15.25 | 54.0 | 23.25 | 5390 |
| 36 | 30 | 250 | 1.15 | 1.03 | 56.0 | 15.25 | 56.0 | 23.25 | 5805 |
| 36 | 36 | 250 | 1.15 | 1.15 | 60.0 | 19.50 | 60.0 | 27.5 | 6335 |
| 42 | 24 | 250 | 1.28 | .89 | 60.0 | 12.00 | 60.0 | — | — |
| 48 | 36 | 250 | 1.96 | 1.58 | 64.0 | 5.0 | 68.0 | — | 9065 |

If dimensions and/or weights for this fitting are critical, please contact your AMERICAN customer service representative for assistance.

All center dimensions reflect the C153 standard minimum dimension.

*Higher pressure rated Wyes may be available in some sizes. Check AMERICAN.

Numerals on cuts indicate standard order of specifying size of fitting.

Other joints (e.g. Fastite, Flex-Ring, or Lok-Ring) are available in some sizes. Check AMERICAN.

Wyes Are Special...

...and if a standard tee and 45° bend, as shown, can satisfactorily meet the requirement—particularly in large-diameter piping—it may be advantageous to use them.

Note: Welded-on lateral outlets may be preferable to wyes in some cases from a layout, installation and economical standpoint. See Section 7.

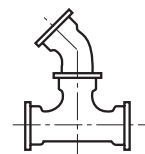

MJ Tee with MJ & PE 45° Bend



AMERICAN Ductile Iron Mechanical Joint Fittings

AMERICAN Standard Compact Wyes

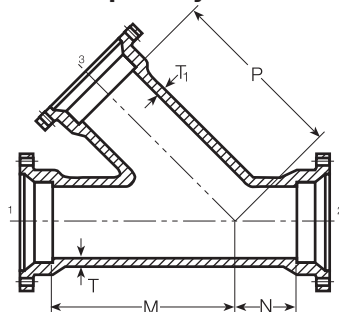

All MJ Wye

Table No. 5-16

| Size in. | | Pressure Rating* psi | Dimensions in Inches | | | Weight in Pounds |
|----------|--------|-------------------------|----------------------|------|------|------------------|
| Run | Branch | | M | N | P | |
| 4 | 4 | 250 | 9.5 | 2.5 | 9.5 | 45 |
| 6 | 6 | 250 | 13.0 | 3.0 | 13.0 | 93 |
| 8 | 8 | 250 | 16.0 | 3.5 | 16.0 | 136 |
| 10 | 10 | 250 | 19.0 | 3.5 | 19.0 | 199 |
| 12 | 12 | 250 | 22.5 | 4.5 | 22.5 | 272 |
| 14 | 14 | 250 | 25.0 | 6.0 | 25.0 | 465 |
| 16 | 16 | 250 | 28.0 | 6.5 | 28.0 | 575 |
| 18 | 18 | 350 | 30.0 | 6.5 | 30.0 | 500 |
| 20 | 20 | 350 | 33.0 | 8.0 | 33.0 | 747 |
| 24 | 24 | 350 | 38.5 | 9.0 | 38.5 | 1061 |
| 30 | 30 | 350 | 50.0 | 10.0 | 50.0 | 2200 |
| 36 | 30 | 350 | 54.0 | 15.0 | 54.0 | 2491.47 |
| 36 | 36 | 350 | 57.5 | 15.0 | 57.5 | 4754 |
| 42 | 42 | 350 | 68.0 | 15.0 | 68.0 | 4048 |
| 48 | 48 | 350 | 75.0 | 16.0 | 75.0 | - |

If dimensions and/or weights for this fitting are critical, please contact your AMERICAN customer service representative for assistance.
 Numerals on cuts indicate standard order of specifying size of fitting.
 *Higher pressure rated Wyes may be available in some sizes. Check AMERICAN.



**AMERICAN Ductile Iron Mechanical Joint Fittings
ANSI/AWWA C110/A21.10, C153/A21.53, and AMERICAN Standard
Sleeves**

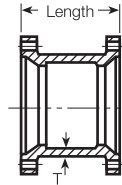

MJ Sleeve

Table No. 5-17 AWWA C153-Compact

| Size in. | Pressure Rating psi | T in. | Short | | Long | |
|----------|---------------------|-------|------------|-----------|------------|-----------|
| | | | Length in. | Weight lb | Length in. | Weight lb |
| 4 | 350 | .34 | 7.5 | 17 | 12.0 | 20 |
| 6 | 350 | .36 | 7.5 | 28 | 12.0 | 33 |
| 8 | 350 | .38 | 7.5 | 38 | 12.0 | 46 |
| 10 | 350 | .40 | 7.5 | 49 | 12.0 | 62 |
| 12 | 350 | .42 | 7.5 | 56 | 12.0 | 76 |
| 14 | 350 | .47 | 9.5 | 111 | 15.0 | 140 |
| 16 | 350 | .50 | 9.5 | 123 | 15.0 | 170 |
| 18 | 350 | .54 | 9.0 | 160 | 15.0 | 200 |
| 20 | 350 | .57 | 9.0 | 195 | 15.0 | 255 |
| 24 | 350 | .61 | 9.0 | 225 | 15.0 | 335 |
| 30 | 250 | .66 | 15.0 | 423 | 24.0 | 640 |
| 36 | 250 | .74 | 15.0 | 591 | 24.0 | 925 |
| 42 | 250 | .82 | 15.0 | 788 | 24.0 | 1390 |
| 48 | 250 | .90 | 15.0 | 978 | 24.0 | 1740 |

Table No. 5-18 AWWA C110

| Size in. | Pressure Rating psi | T in. | Solid Sleeves | |
|----------|---------------------|-------|---------------|-----------|
| | | | Length in. | Weight lb |
| 30 | 250 | 1.03 | 15 | 635 |
| 36 | 250 | 1.15 | 15 | 855 |
| 42 | 250 | 1.28 | 24 | 1550 |
| 42 | 250 | 1.78 | — | — |
| 48 | 250 | 1.42 | 24 | 1940 |
| 48 | 250 | 1.96 | — | — |

If dimensions and/or weights for this fitting are critical, please contact your AMERICAN customer service representative for assistance.
 All center dimensions reflect the C153 standard minimum dimension.
 In many cases, fabricated sleeves/couplings accomplish the same in-stall[ation] objectives as mechanical joint sleeves. "Drop-in" restraint can be provided by coupling gland ends. (See Section 9.) Contact manufacturers for details.
 Fabricated sleeves are also readily available from various manufacturers for coupling ductile iron pipe plain ends to pipe plain ends of other material types and other outside diameters.



AMERICAN Ductile Iron Mechanical Joint Fittings

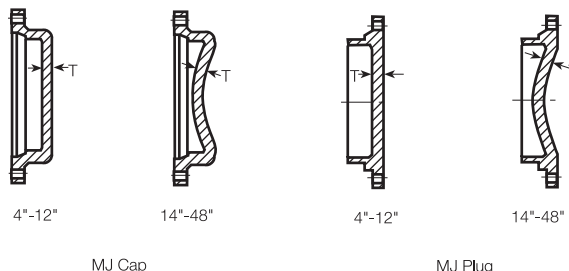

ANSI/AWWA C153/A21.53 Compact Caps and Plugs

Table No. 5-19

| Size in. | Pressure Rating psi | T in. | Weight in Pounds | |
|----------|---------------------|-------|------------------|---------|
| | | | MJ Cap | MJ Plug |
| 4 | 350 | .46 | 9 | 10 |
| 6 | 350 | .46 | 15 | 16 |
| 8 | 350 | .46 | 22 | 26 |
| 10 | 350 | .56 | 32 | 36 |
| 12 | 350 | .56 | 42 | 46 |
| 14 | 350 | .62 | 66 | 75 |
| 16 | 350 | .62 | 92 | 95 |
| 18 | 350 | .65 | 114 | 121 |
| 20 | 350 | .66 | 125 | 135 |
| 24 | 350 | .68 | 166 | 175 |
| 30 | 250 | .76 | 345 | 355 |
| 36 | 250 | .76 | 628 | 688 |
| 42 | 250 | .76 | 665 | 815 |
| 48 | 250 | .76 | 901 | 1085 |

If dimensions and/or weights for this fitting are critical, please contact your AMERICAN customer service representative for assistance.

All center dimensions reflect the C153 standard minimum dimension.

Normally, sizes 12" and smaller caps and plugs are flat and 14" and larger are dished. This is subject to change depending on foundry equipment. Caps and plugs can be furnished tapped for service connections or testing purposes. Thicknesses and weights of some caps and plugs may be more than specified in AWWA C153.

ANSI/AWWA C110/A21.10 Caps and Plugs

Table No. 5-20

| Size in. | Pressure Rating psi | T in. | Weight in Pounds | |
|----------|---------------------|-------|------------------|---------|
| | | | MJ Cap | MJ Plug |
| 30 | 250 | 1.03 | 590 | 573 |
| 36 | 250 | 1.15 | 850 | 815 |
| 42 | 250 | 1.28 | 1180 | 1110 |
| 48 | 250 | 1.42 | 1595 | 1455 |

If dimensions and/or weights for this fitting are critical, please contact your AMERICAN customer service representative for assistance.

All center dimensions reflect the C153 standard minimum dimension.

Normally, 30" and larger caps and plugs are dished. This is subject to change depending on foundry equipment.

Caps and plugs can be furnished tapped for service connections or testing purposes.

A lifting eye is furnished on all 30" and larger caps and plugs.

Thicknesses and weights of some caps and plugs may be more than specified in AWWA C110.



**AMERICAN Ductile Iron Mechanical Joint Fittings
ANSI/AWWA C153/A21.53
AMERICAN Standard
Swivel Tees and Glands**

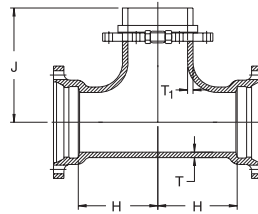

MJ and Swivel Tees

Table No. 5-21

| Size in. | | Pressure Rating psi | Dimensions in Inches | | | | Weight in lbs. |
|----------|--------|---------------------|----------------------|----------------------|-----|-------|----------------|
| Run | Branch | | T (nom) | T ₁ (nom) | H | J | |
| 6 | 6 | 350 | .36 | .36 | 5.0 | 9.00 | 57 |
| 8 | 6 | 350 | .38 | .36 | 5.0 | 10.00 | 71 |
| 8 | 8 | 350 | .38 | .38 | 6.5 | 10.25 | 84 |
| 10 | 6 | 350 | .40 | .36 | 5.0 | 11.00 | 93 |
| 10 | 8 | 350 | .40 | .38 | 6.5 | 11.25 | 109 |
| 12 | 6 | 350 | .42 | .36 | 5.0 | 12.25 | 113 |
| 12 | 8 | 350 | .42 | .38 | 6.5 | 12.50 | 130 |

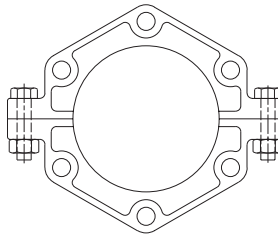

Swivel Glands

Table No. 5-22

| Size in. | Wt. |
|----------|-----|
| 6 | 5 |
| 8 | 7 |

If dimensions and/or weights for this fitting are critical, please contact your AMERICAN customer service representative for assistance.
All center dimensions reflect the C153 standard minimum dimension.



AMERICAN Ductile Iron Mechanical Joint Fittings
ANSI/AWWA C111/A21.11
AMERICAN Standard
Glands



M.I. Gland

Table No. 5-23

| Size in. | Weight in Pounds* |
|-------------|----------------------|
| | Gland |
| 4 | 7 |
| 6 | 12 |
| 8 | 16 |
| 10 | 22 |
| 12 | 28 |
| 14 | 45 |
| 16 | 52 |
| 18 | 62 |
| 20 | 75 |
| 24 | 97 |
| 30 | 196 |
| 36 | 246 |
| 42 | 302 |
| 48 | 380 |

If dimensions and/or weights for this fitting are critical, please contact your AMERICAN customer service representative for assistance.

All center dimensions reflect the C153 standard minimum dimension.

*Gland weights may be less than shown because of pattern changes.

Special Glands

MJ Glands for "D" pattern pipe are special and cannot be interchanged with standard MJ Glands or MJ Split Glands. MJ Transition gaskets in the 12" and smaller sizes are used with standard MJ glands for connections to steel pipe O.D. products. Transition sleeves, glands, and gaskets are no longer available in the 14" and larger sizes. (See footnote under Table 5-19.) Various designs of MJ retainer gland devices, designed and manufactured by others, are available. AMERICAN does not warrant the performance of joints utilizing such devices; however, AMERICAN has designed and does manufacture a number of restrained joints, such as Fast-Grip, Flex-Ring, Field Flex-Ring, Lok-Ring, and Flex-Lok shown in Section 9, that do carry AMERICAN's standard warranty.



AMERICAN

DUCTILE IRON PIPE

THE RIGHT WAY

Section 6

AMERICAN Ductile Iron Flanged Fittings



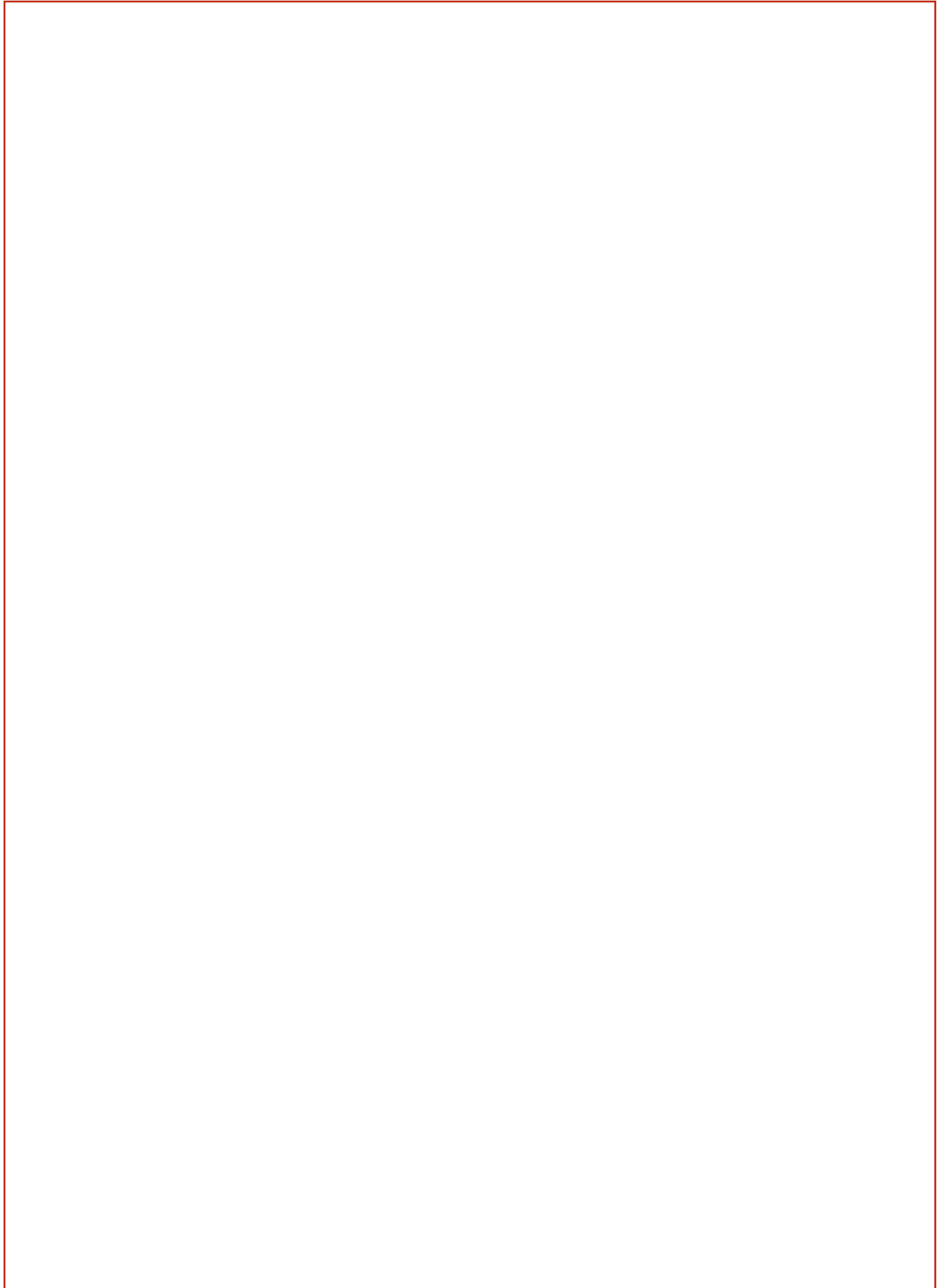



AMERICAN Ductile Iron Flanged Fittings

The principal standard covering flanged fittings is ANSI/AWWA C110/A21.10. 54"–64" flanged fittings are covered in ANSI/AWWA C153/A21.53. These and other standards are referenced throughout this section either by the full ANSI/AWWA designation or by only the AWWA numbering, such as AWWA C110 or C153.

AMERICAN produces a complete line of standard as well as specialized flanged fittings for various types of service including water, sewage, and air.

Fittings ANSI/AWWA C110/A21.10

Most of the flanged fittings furnished by AMERICAN are manufactured in accordance with the requirements of this standard. The tables in this section in which these fittings are listed have heading "ANSI/AWWA C110/A21.10." The AWWA C110 fitting flanges have facing and drilling that match AWWA C115 threaded-on flanges (see Section 8) and also match ANSI B16.1 Class 125 flanges.

AMERICAN manufactures some fittings that are not included in AWWA C110 including long radius 90° bends, reducing bends, wyes, and various other fittings that are commonly used in plant piping. These have AWWA C110 flanges and are listed in the tables with heading "AMERICAN Standard." The pressure ratings shown are AMERICAN standard and are based on AWWA C110 design principles.

The AWWA C110 flanges are adequate for a water working pressure of 250 psi with the body of the fitting being suitable for 150 psi or 250 psi, as indicated in the tables. In some cases, these fittings have been supplied for greater water working pressure applications, particularly when used with AMERICAN Toruseal® gaskets.

Fittings ANSI/AWWA C153/A21.53

54", 60" and 64" fittings are manufactured in accordance with AWWA C153. These fittings are compact, and the bodies are essentially the same as ISO 2531 fittings in these sizes. Tables including these sizes will include "C153/A21.53" in the heading. Flanges match AWWA C115 and ANSI B16.1 (Class 125) flanges and are adequate for a water working pressure of 250 psi. (64" flanges match 66" flanges. See Table No. 6-1.) The bodies of these fittings are suitable for 150 psi or 250 psi as indicated in the tables. In some cases, these fittings have been supplied for greater water working pressure applications, particularly when used with AMERICAN Toruseal® gaskets.

Fittings Class 250 F&D

Except for a transition piece from an ANSI B16.1 Class 250 flange to a standard AWWA C110 flange, AMERICAN no longer makes fittings with flanges faced and drilled per ANSI B16.1 Class 250. As noted in AWWA C111, flange joints in the 24" and smaller sizes may be rated for up to 350 psi with the use of special gaskets such as AMERICAN's Toruseal®.

Furthermore, AMERICAN is able to rate flange pipe and fittings higher than 250 or even 350 psi on special applications. Information on fittings Class 250 F&D previously furnished by AMERICAN can be found in the Historical Data Section of this Pipe Manual.



AMERICAN offers a complete line of 4"– 64" flanged pipe and fittings for treatment plant piping.



Elevated Pressure/Temperature Applications

Contact AMERICAN for elevated pressure and/or temperature capabilities of ductile iron flanges.

General Notes Relating to Flanged Fittings

1. Fittings in the following tables headed "ANSI/AWWA C110/A21.10 or C153/A21.53" are as specified in these standards, except as noted. Fittings listed in tables headed "AMERICAN Standard" are either not included in this ANSI/AWWA standard or vary in weights and/or dimensions. AMERICAN does not manufacture any fittings to the requirements of ANSI B16.1 except for laying dimensions, and facing and drilling as specifically noted.
2. Fittings are manufactured of ductile iron meeting the requirements of AWWA C110 or C153, as applicable.
3. Flanges can be tapped for studs when specified. (See Section 8, Table No. 8-3.)
4. All pressure ratings shown are for water service.
5. Unless otherwise specified, flanges will have bolt holes straddling centerline. Bolt hole drilling can be rotated when so specified.
6. Center-to-face dimensions of reducing tees and crosses, with or without side outlet, and of reducing wyes are as follows (See Table No. 6-2).
 - a. 16" and smaller sizes have the same center-to-face dimensions as straight sizes corresponding to the size of the largest opening.
 - b. The center-to-face dimensions of 18" and larger sizes are governed by the size of the branch or side outlet; for fittings with both branch and side outlet, the larger of the two governs.
7. Tees, crosses and wyes, reducing on the run only, have the same dimensions center-to-face and face-to-face as straight size fittings corresponding to the size of the largest opening.
8. Reducing bends have the same center-to-face dimensions as straight size bends corresponding to the size of the largest opening.
9. Reducers and eccentric reducers for all reductions have the same face-to-face dimensions based on the larger opening.
10. Flanged fittings are manufactured to the following tolerances:
 - Flange thickness—
 - Sizes 2"-12" inclusive, ± 0.12 in.
 - Sizes 14"-24" inclusive, ± 0.19 in.
 - Sizes 30"-64" inclusive, ± 0.25 in.
 - Laying Length—
 - Sizes 2"-10" inclusive, ± 0.06 in.
 - Sizes 12"-64" inclusive, ± 0.12 in.Laying length tolerances are for face-to-face dimensions; the center-to-face tolerances are one half of the face-to-face tolerances.
11. The largest opening of the fitting governs the laying length tolerances for all openings. For compliance with the flange thickness tolerance, flanges may be back faced or spot faced, AMERICAN's option.
12. Some fittings are available with body metal thickness other than as listed. Some fittings are available in different sizes and with different size combinations than shown. All sizes and body metal thicknesses listed may not be available due to changes in foundry practice. Check AMERICAN regarding any special requirements.
13. Weights of fittings can vary due to changes in foundry practice.
14. See Section 7 for AMERICAN specials.
15. AMERICAN may furnish fittings manufactured by others. Any such fittings will be manufactured in accordance with appropriate ANSI/AWWA standards.
16. While AWWA C153 shows 54"-64" with 150 psi ratings, AMERICAN rates most 54"-64" fittings 250 psi as AMERICAN standard based on performance testing.



AMERICAN Ductile Iron Flanged Fittings Applications of Standard Fittings

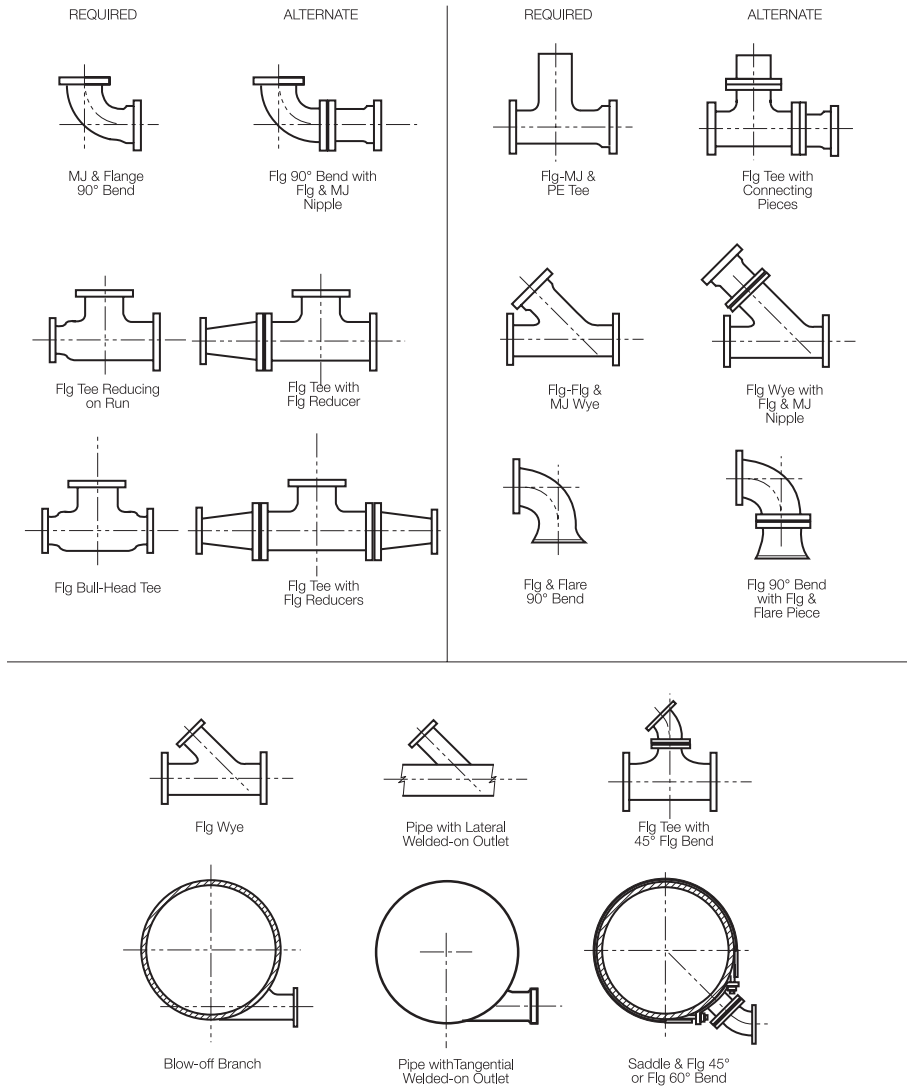

In many cases, special fittings for various conditions are required. Some of the more common of these are shown above in columns headed "Required." Under the columns headed "Alternate," are shown combinations of standard fittings that in some situations will provide the desired connection. For economy and/or shipment from stock, it is often advantageous to use the standard fittings.

***Note:** In lieu of tees, blow-off branches, and wyes (and particularly those with reduced-size branches), the designer should consider for optimum design, layout, and installation the use of fabricated outlet pipe, tangential outlet pipe, and lateral outlets as explained in Sec. 7.



AMERICAN Ductile Iron Flanged Fittings
ANSI/AWWA C110/A21.10, C111/A21.11 or C153/A21.53
Flange Details O.D.

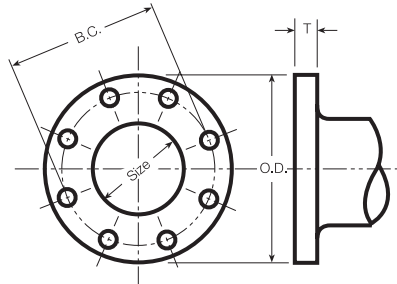

Table No. 6-1

| Size in. | O.D. in. | B.C. in. | T in. | Bolt Hole Diameter in. | Bolts | |
|----------|----------|----------|-------|------------------------|---------------|---------------|
| | | | | | No. Per Joint | Size in. |
| 3 | 7.50 | 6.00 | .75 | 3/4 | 4 | 5/8 x 2 1/2 |
| 4 | 9.00 | 7.50 | .94 | 3/4 | 8 | 5/8 x 3 |
| 6 | 11.00 | 9.50 | 1.00 | 7/8 | 8 | 3/4 x 3 1/2 |
| 8 | 13.50 | 11.75 | 1.12 | 7/8 | 8 | 3/4 x 3 1/2 |
| 10 | 16.00 | 14.25 | 1.19 | 1 | 12 | 7/8 x 4 |
| 12 | 19.00 | 17.00 | 1.25 | 1 | 12 | 7/8 x 4 |
| 14 | 21.00 | 18.75 | 1.38 | 1 1/8 | 12 | 1 x 4 1/2 |
| 16 | 23.50 | 21.25 | 1.44 | 1 1/8 | 16 | 1 x 4 1/2 |
| 18 | 25.00 | 22.75 | 1.56 | 1 1/4 | 16 | 1 1/8 x 5 |
| 20 | 27.50 | 25.00 | 1.69 | 1 1/4 | 20 | 1 1/8 x 5 |
| 24 | 32.00 | 29.50 | 1.88 | 1 3/8 | 20 | 1 1/4 x 5 1/2 |
| 30 | 38.75 | 36.00 | 2.12 | 1 3/8 | 28 | 1 1/4 x 6 1/2 |
| 36 | 46.00 | 42.75 | 2.38 | 1 5/8 | 32 | 1 1/2 x 7 |
| 42 | 53.00 | 49.50 | 2.62 | 1 5/8 | 36 | 1 1/2 x 7 1/2 |
| 48 | 59.50 | 56.00 | 2.75 | 1 5/8 | 44 | 1 1/2 x 8 |
| 54 | 66.25 | 62.75 | 3.00 | 2 | 44 | 1 3/4 x 8 1/2 |
| 60 | 73.00 | 69.25 | 3.12 | 2 | 52 | 1 3/4 x 9 |
| **64 | 80.00 | 76.00 | 3.38 | 2 | 52 | 1 3/4 x 9 |

**The dimensions of 64" flange correspond with applicable dimensions of 66" Class E in ANSI/AWWA C207, and 64" ductile iron flanges can be connected to those flanges.

FACING: Flanges are plain faced and are finished smooth or with shallow serrations (AMERICAN's option).

BACK FACING: Flanges may be back faced or spot faced, AMERICAN's option, for compliance with the flange thickness tolerance.

FLANGES: The flanges shown above are adequate for water service of 250 psi working pressure and should not be confused with Class 250 flanges per ANSI B16.1. The bolt circle and the bolt holes match those of ANSI B16.1 Class 125. If flanges are required to be made in accordance with other ratings or other standards, this must be specified on the purchase order. 24" and smaller flanges are rated equal to the fittings to which they are attached and are adequate for water service of greater than 350 psi only with the use of AMERICAN's Toruseal® gaskets.

Drilling of flanges can be rotated when required; for those sizes with an even number of bolt holes in each quadrant, fitting can be rotated 45° with standard drilling.

AMERICAN recommends AMERICAN Toruseal® gaskets shown on page 6-21 be used for normal water service.

See Section 8, Table No. 8-3 for information on bolts and studs.

See General Notes on page 6-2.



AMERICAN Ductile Iron Flanged Fittings AMERICAN Standard

Method of Designating Location of Tapped Holes and Sequence of Openings

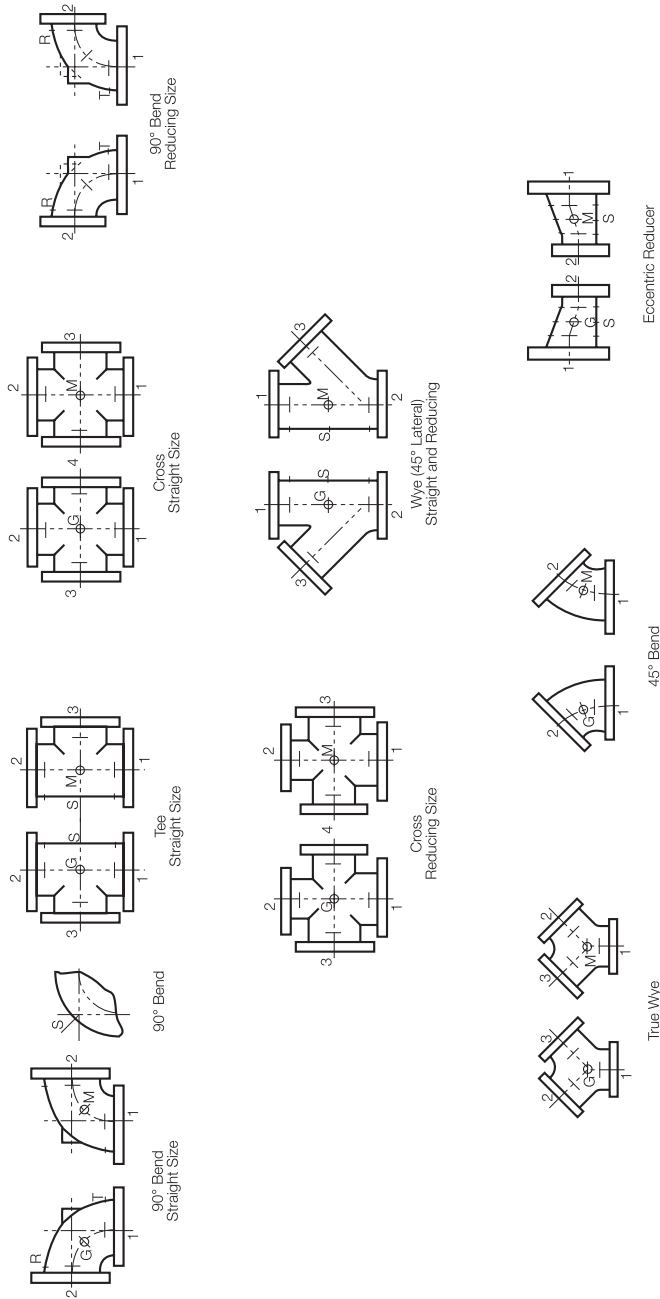

Taps are made directly into the wall of the flanged fitting. Tap diameter depends on the fitting wall thickness and will vary on the diameter of the fitting. In the designation of the openings of reducing fittings, they should be read in the order indicated by the sequence of the numbers 1, 2, 3 and 4 as shown. Maximum tap diameter depends on the fitting wall thickness.

Note that numbering sequence for wye ends differs from that shown in ANSI B16.1 standard (for gray cast iron flanged items).



**AMERICAN Ductile Iron Flanged Fittings
ANSI/AWWA C110/A21.10, C153/A21.53, or AMERICAN Standard
Flanged Fitting Dimensions and Designation of Outlets**

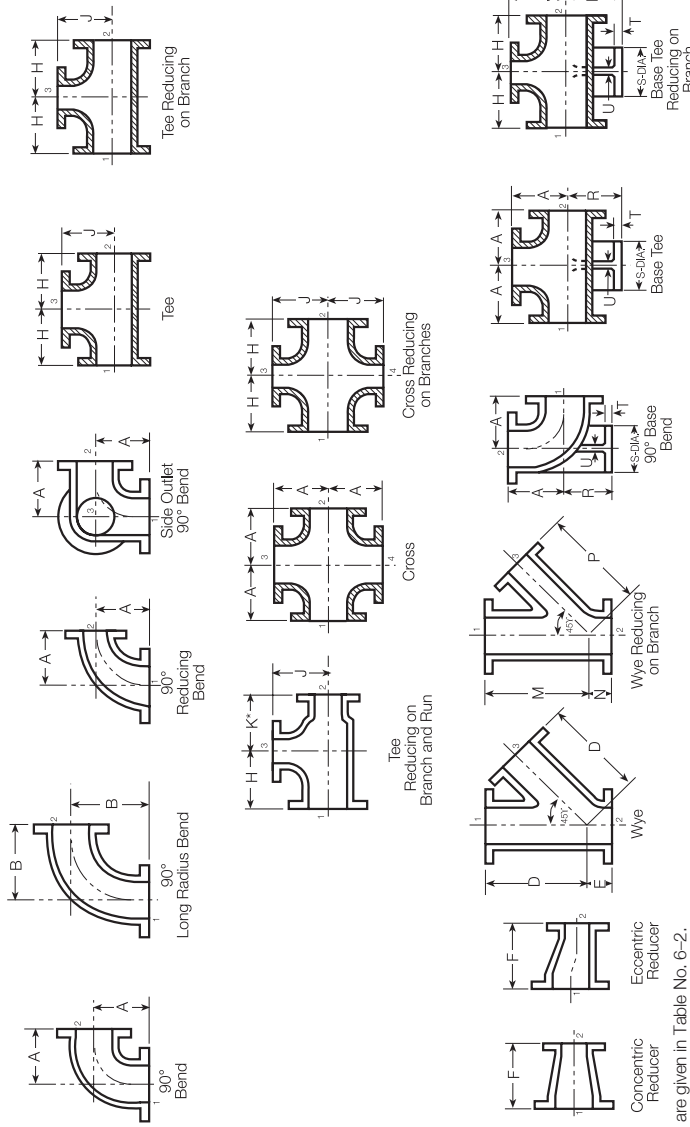

Dimensions for above fittings are given in Table No. 6-2. Some of the above fittings are not listed in AWWA C110 but do meet applicable requirements of AWWA C110. The largest opening establishes the basic size of a reducing fitting. The largest opening is named first, except for bull-head tees and double branch bends where both branches are reducing; in these two cases, the largest opening is named last.

In the designation of the openings of reducing fittings, they should be read in the order indicated by the sequence of the numbers 1, 2, 3 and 4 as shown.

In describing tees reducing on the branch only, the first size applies to both outlets on the run. Similarly, for crosses with the same size for both run outlets and the same size for both branch outlets, it is necessary to indicate only two sizes. For example: for an 8 x 6 tee or wye, it is not necessary to show 8 x 6 x 6.



AMERICAN Ductile Iron Flanged Fittings
ANSI/AWWA C110/A21.10, C153/A21.53, or AMERICAN Standard
Flanged Fittings Dimensions

Table No. 6-2

| Size in. | Dimensions in Inches Reducing Tees | | | | | | | | | | Reducing Tees and Crosses | | | | Reducing Wyes* | | | |
|-------------|------------------------------------|-------|------|----------------------|----------------------|----|-------|-------------|------|------|--|----|------|---------------------------------------|----------------------|------|------|--|
| | A | B | C | D** | E** | F | R | S (Dia.) | T | U | Size of Branches and Smaller *** | H | J | Size of Branches and Smaller | M | N | P | |
| 3 | 5.5 | 7.75 | 3.0 | 10.0 | 3.0 | 6 | 4.88 | 5.00 | .56 | .50 | - | † | † | - | †† | †† | †† | |
| 4 | 6.5 | 9.00 | 4.0 | 12.0 | 3.0 | 7 | 5.50 | 6.00 | .62 | .50 | - | † | † | - | †† | †† | †† | |
| 6 | 8.0 | 11.50 | 5.0 | 14.5 | 3.5 | 9 | 7.00 | 7.00 | .69 | .62 | - | † | † | - | †† | †† | †† | |
| 8 | 9.0 | 14.00 | 5.5 | 17.5 | 4.5 | 11 | 8.38 | 9.00 | .84 | .88 | - | † | † | - | †† | †† | †† | |
| 10 | 11.0 | 16.50 | 6.5 | 20.5 | 5.0 | 12 | 9.75 | 9.00 | .94 | .88 | - | † | † | - | †† | †† | †† | |
| 12 | 12.0 | 19.00 | 7.5 | 24.5 | 5.5 | 14 | 11.25 | 11.00 | 1.00 | 1.00 | - | † | † | - | †† | †† | †† | |
| 14 | 14.0 | 21.50 | 7.5 | 27.0 | 6.0 | 16 | 12.50 | 11.00 | 1.00 | 1.00 | - | † | † | - | †† | †† | †† | |
| 16 | 15.0 | 24.00 | 8.0 | 30.0 | 6.5 | 18 | 13.75 | 11.00 | 1.00 | 1.00 | - | † | † | - | †† | †† | †† | |
| 18 | 16.5 | 26.50 | 8.5 | 32.0 | 7.0 | 19 | 15.00 | 13.50 | 1.12 | 1.12 | 12 | 13 | 15.5 | 8 | 25.0 | 1.00 | 27.5 | |
| 20 | 18.0 | 29.00 | 9.5 | 35.0 | 8.0 | 20 | 16.00 | 13.50 | 1.12 | 1.12 | 14 | 14 | 17.0 | 10 | 27.0 | 1.00 | 29.5 | |
| 24 | 22.0 | 34.00 | 11.0 | 40.5 | 9.0 | 24 | 18.50 | 13.50 | 1.12 | 1.12 | 16 | 15 | 19.0 | 12 | 40.5 | 9.00 | 40.5 | |
| 30 | 25.0 | 41.50 | 15.0 | See Table No. 6-8 | See Table No. 6-8 | 30 | 23.00 | 16.00 | 1.19 | 1.15 | 20 | 18 | 23.0 | - | See Table No. 6-8 | | | |
| 36 | 28.0 | 49.00 | 18.0 | | | 36 | 26.00 | 19.00 | 1.25 | 1.15 | 24 | 20 | 26.0 | - | | | | |
| 42 | 31.0 | 56.50 | 21.0 | | | 42 | 30.00 | 23.50 | 1.44 | 1.28 | 24 | 23 | 30.0 | - | | | | |
| 48 | 34.0 | 64.00 | 24.0 | | | 48 | 34.00 | 25.00 | 1.56 | 1.42 | 30 | 26 | 34.0 | - | | | | |
| 54 | 39.0 | - | 20.5 | - | - | § | 38.00 | 27.50 | 1.69 | 1.55 | §§ | §§ | §§ | - | - | - | - | |
| 60 | 43.0 | - | 23.5 | - | - | § | 42.00 | 32.00 | 1.88 | 1.75 | §§ | §§ | §§ | - | - | - | - | |
| 64 | 48.0 | - | 25.0 | - | - | § | 44.00 | 38.75 | 2.12 | 1.75 | §§ | §§ | §§ | - | - | - | - | |

*AWWA C110 and C153 do not include data on wyes of any size.

**See footnote to Table No. 6-8.

***For larger branches, use "A" dimensions.

†††For these smaller diameter reducing tees and crosses, the "A" dimension applies as shown in "cut" of standard tee and cross.

††For these smaller diameter reducing wyes, the "D" and "E" dimensions apply as shown in "cut" of standard wye.

See General Notes on page 6-2.

§†††† dimensions for 54 - 64" reducers vary with diameters of reduction.

§§†††† dimensions for 54 - 64" tees and crosses vary with diameters of reduction.



AMERICAN Ductile Iron Flanged Fittings
ANSI/AWWA C110/A21.10, C153/A21.53, or AMERICAN Standard
Flanged 90° Bends

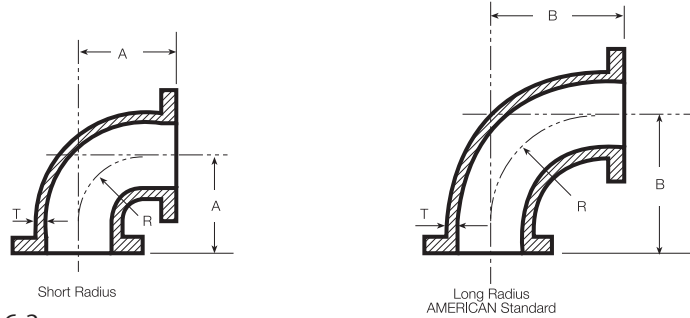

Table No. 6-3

| Size in. | Pressure Rating psi | T in. | Short Radius | | | Long Radius | | |
|----------|---------------------|-------|--------------|-------|-----------|-------------|-------|-----------|
| | | | A in. | R in. | Weight lb | B in. | R in. | Weight lb |
| 4 | 250 | .52 | 6.5 | 4.5 | 40 | 9.00 | 7.00 | 50 |
| 6 | 250 | .55 | 8.0 | 6.0 | 65 | 11.50 | 9.50 | 80 |
| 8 | 250 | .60 | 9.0 | 7.0 | 105 | 14.00 | 12.00 | 140 |
| 10 | 250 | .68 | 11.0 | 9.0 | 165 | 16.50 | 14.50 | 215 |
| 12 | 250 | .75 | 12.0 | 10.0 | 240 | 19.00 | 17.00 | 325 |
| 14 | 250 | .66 | 14.0 | 11.5 | 290 | 21.50 | 19.00 | 385 |
| 16 | 250 | .70 | 15.0 | 12.5 | 370 | 24.00 | 21.50 | 505 |
| 18 | 250 | .75 | 16.5 | 14.0 | 450 | 26.50 | 24.00 | 630 |
| 20 | 250 | .80 | 18.0 | 15.5 | 575 | 29.00 | 26.50 | 810 |
| 24 | 250 | .89 | 22.0 | 18.5 | 900 | 34.00 | 30.50 | 1240 |
| 30 | 250 | 1.03 | 25.0 | 21.5 | 1430 | 41.50 | 38.00 | 2105 |
| 36 | 250 | 1.15 | 28.0 | 24.5 | 2135 | 49.00 | 45.50 | 3285 |
| 42 | 250 | 1.28 | 31.0 | 27.5 | 3055 | 56.50 | 53.00 | 4865 |
| 48 | 250 | 1.42 | 34.0 | 30.5 | 4090 | 64.00 | 60.50 | 6790 |
| 54 | 250** | .90 | 39.0 | 34.3 | 3740 | - | - | - |
| 60 | 250** | .94 | 43.0 | 36.5 | 4965 | - | - | - |
| 64 | 250** | .99 | 48.0 | 38.8 | 6745 | - | - | - |

**AMERICAN standard 54"-64" fittings are rated only 150 psi in AWWA C153.
 The long radius bends are not included in AWWA C110; they have center-to-face and radius dimensions according to ANSI B16.1 Class 125. See Table No. 6-2.
 Long radius bends are available with flanged joint ends only.
 See General Notes on page 6-2.



AMERICAN Ductile Iron Flanged Fittings
AMERICAN Standard
Flanged 90° Reducing Bends

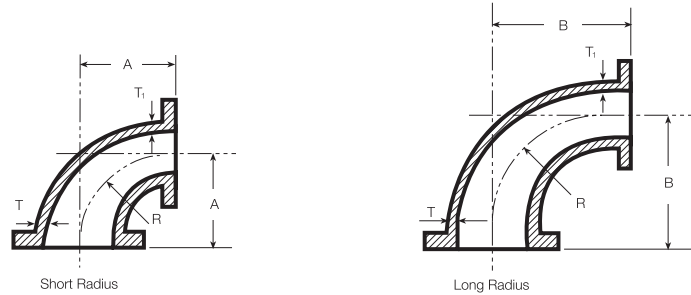

Table No. 6-4

| Size in. | Pressure Rating psi | Short Radius | | | | | Long Radius | | | | |
|----------|---------------------|--------------|--------------------|-------|-------|-----------|-------------|--------------------|-------|-------|-----------|
| | | T in. | T ₁ in. | A in. | R in. | Weight lb | T in. | T ₁ in. | A in. | R in. | Weight lb |
| 6 x 4 | 250 | .55 | .52 | 8.0 | 6.0 | 55 | .55 | .52 | 11.5 | 9.5 | 70 |
| 8 x 4 | 250 | .60 | .52 | 9.0 | 7.0 | 75 | .60 | .52 | 14.0 | 12.0 | 100 |
| 8 x 6 | 250 | .60 | .55 | 9.0 | 7.0 | 95 | .60 | .55 | 14.0 | 12.0 | 115 |
| 10 x 4 | 250 | .68 | .52 | 11.0 | 9.0 | 130 | .68 | .52 | 16.5 | 14.5 | 195 |
| 10 x 6 | 250 | .68 | .55 | 11.0 | 9.0 | 130 | .68 | .55 | 16.5 | 14.5 | 180 |
| 10 x 8 | 250 | .68 | .60 | 11.0 | 9.0 | 155 | .68 | .60 | 16.5 | 14.5 | 215 |
| 12 x 4 | 250 | .75 | .52 | 12.0 | 10.0 | 140 | .68 | .60 | 16.5 | 14.5 | 215 |
| 12 x 6 | 250 | .75 | .55 | 12.0 | 10.0 | 160 | .75 | .55 | 19.0 | 17.0 | 235 |
| 12 x 8 | 250 | .75 | .60 | 12.0 | 10.0 | 190 | .75 | .60 | 19.0 | 17.0 | 285 |
| 12 x 10 | 250 | .75 | .68 | 12.0 | 10.0 | 200 | .75 | .68 | 19.0 | 17.0 | 325 |
| 14 x 6 | 250 | .66 | .55 | 14.0 | 11.5 | 190 | .66 | .55 | 21.5 | 19.0 | |
| 14 x 8 | 250 | .66 | .60 | 14.0 | 11.5 | 215 | .66 | .60 | 21.5 | 19.0 | 285 |
| 14 x 10 | 250 | .66 | .68 | 14.0 | 11.5 | 240 | .66 | .68 | 21.5 | 19.0 | 325 |
| 14 x 12 | 250 | .66 | .75 | 14.0 | 11.5 | 280 | .66 | .75 | 21.5 | 19.0 | 370 |
| 16 x 6 | 250 | .70 | .55 | 15.0 | 12.5 | 220 | .70 | .55 | 24.0 | 21.5 | |
| 16 x 8 | 250 | .70 | .60 | 15.0 | 12.5 | 255 | .70 | .60 | 24.0 | 21.5 | |
| 16 x 10 | 250 | .70 | .68 | 15.0 | 12.5 | 285 | .70 | .68 | 24.0 | 21.5 | 395 |
| 16 x 12 | 250 | .70 | .75 | 15.0 | 12.5 | 325 | .70 | .75 | 24.0 | 21.5 | 445 |
| 16 x 14 | 250 | .70 | .66 | 15.0 | 12.5 | 335 | .70 | .66 | 24.0 | 21.5 | 460 |
| 18 x 6 | 250 | .75 | .55 | 16.5 | 14.0 | 260 | .75 | .55 | 26.5 | 24.0 | |
| 18 x 8 | 250 | .75 | .60 | 16.5 | 14.0 | 330 | .75 | .60 | 26.5 | 24.0 | |
| 18 x 10 | 250 | .75 | .68 | 16.5 | 14.0 | 330 | .75 | .68 | 26.5 | 24.0 | 465 |
| 18 x 12 | 250 | .75 | .75 | 16.5 | 14.0 | 375 | .75 | .75 | 26.5 | 24.0 | |
| 18 x 14 | 250 | .75 | .66 | 16.5 | 14.0 | 385 | .75 | .66 | 26.5 | 24.0 | 535 |
| 18 x 16 | 250 | .75 | .70 | 16.5 | 14.0 | 420 | .75 | .70 | 26.5 | 24.0 | 585 |
| 20 x 6 | 250 | .80 | .55 | 18.0 | 15.5 | 320 | .80 | .55 | 29.0 | 26.5 | |
| 20 x 8 | 250 | .80 | .60 | 18.0 | 15.5 | 345 | .80 | .60 | 29.0 | 26.5 | |
| 20 x 10 | 250 | .80 | .68 | 18.0 | 15.5 | 445 | .80 | .68 | 29.0 | 26.5 | |
| 20 x 12 | 250 | .80 | .75 | 18.0 | 15.5 | 415 | .80 | .75 | 29.0 | 26.5 | 630 |
| 20 x 14 | 250 | .80 | .66 | 18.0 | 15.5 | 455 | .80 | .66 | 29.0 | 26.5 | |
| 20 x 16 | 250 | .80 | .70 | 18.0 | 15.5 | 495 | .80 | .70 | 29.0 | 26.5 | 695 |
| 20 x 18 | 250 | .80 | .75 | 18.0 | 15.5 | 525 | .80 | .75 | 29.0 | 26.5 | 717 |
| 24 x 6 | 250 | .89 | .55 | 22.0 | 18.5 | 480 | .89 | .55 | 34.0 | 30.5 | |
| 24 x 8 | 250 | .89 | .60 | 22.0 | 18.5 | 505 | .89 | .60 | 34.0 | 30.5 | |
| 24 x 10 | 250 | .89 | .68 | 22.0 | 18.5 | 545 | .89 | .68 | 34.0 | 30.5 | |
| 24 x 12 | 250 | .89 | .75 | 22.0 | 18.5 | 575 | .89 | .75 | 34.0 | 30.5 | 855 |
| 24 x 14 | 250 | .89 | .66 | 22.0 | 18.5 | 635 | .89 | .66 | 34.0 | 30.5 | 875 |
| 24 x 16 | 250 | .89 | .70 | 22.0 | 18.5 | 685 | .89 | .70 | 34.0 | 30.5 | 940 |
| 24 x 18 | 250 | .89 | .75 | 22.0 | 18.5 | 675 | .89 | .75 | 34.0 | 30.5 | |
| 24 x 20 | 250 | .89 | .80 | 22.0 | 18.5 | 740 | .89 | .80 | 34.0 | 30.5 | 1080 |

30" and 36" short radius reducing bends can be furnished with any combination of Flanged, MJ, Fastite, or Flex-Ring Joints.
 42" and 48" short radius reducing bends can be furnished with any combination of Flanged, MJ, Fastite, or Lok-Ring Joints.



AMERICAN Ductile Iron Flanged Fittings
AMERICAN Standard
Flanged 90° Reducing Bends

Table No. 6-4—Continued

| Size in. | Pressure Rating psi | Short Radius | | | | | Long Radius | | | | |
|----------|---------------------|--------------|--------------------|-------|-------|-----------|-------------|--------------------|-------|-------|-----------|
| | | T in. | T ₁ in. | A in. | R in. | Weight lb | T in. | T ₁ in. | A in. | R in. | Weight lb |
| 30 x 12 | 250 | 1.03 | .75 | 25.0 | 21.5 | 840 | 1.03 | .75 | 41.5 | 38.0 | 1400 |
| 30 x 14 | 250 | 1.03 | .66 | 25.0 | 21.5 | 1090 | 1.03 | .66 | 41.5 | 38.0 | |
| 30 x 16 | 250 | 1.03 | .70 | 25.0 | 21.5 | 900 | 1.03 | .70 | 41.5 | 38.0 | |
| 30 x 18 | 250 | 1.03 | .75 | 25.0 | 21.5 | 980 | 1.03 | .75 | 41.5 | 38.0 | |
| 30 x 20 | 250 | 1.03 | .80 | 25.0 | 21.5 | 1070 | 1.03 | .80 | 41.5 | 38.0 | |
| 30 x 24 | 250 | 1.03 | .89 | 25.0 | 21.5 | 1205 | 1.03 | .89 | 41.5 | 38.0 | |
| 36 x 12 | 250 | 1.15 | .75 | 28.0 | 24.5 | 1195 | 1.15 | .75 | 49.0 | 45.5 | 1575 |
| 36 x 14 | 250 | 1.15 | .66 | 28.0 | 24.5 | 1215 | 1.15 | .66 | 49.0 | 45.5 | |
| 36 x 16 | 250 | 1.15 | .70 | 28.0 | 24.5 | 1255 | 1.15 | .70 | 49.0 | 45.5 | |
| 36 x 18 | 250 | 1.15 | .75 | 28.0 | 24.5 | 1295 | 1.15 | .75 | 49.0 | 45.5 | |
| 36 x 20 | 250 | 1.15 | .80 | 28.0 | 24.5 | 1360 | 1.15 | .80 | 49.0 | 45.5 | |
| 36 x 24 | 250 | 1.15 | .89 | 28.0 | 24.5 | 1520 | 1.15 | .89 | 49.0 | 45.5 | |
| 36 x 30 | 250 | 1.15 | 1.03 | 28.0 | 24.5 | 1785 | 1.15 | 1.03 | 49.0 | 45.5 | |
| 42 x 12 | 250 | 1.28 | .75 | 31.0 | 27.5 | 1655 | 1.28 | .75 | 56.5 | 53.0 | 3673 |
| 42 x 14 | 250 | 1.28 | .66 | 31.0 | 27.5 | 1675 | 1.28 | .66 | 56.5 | 53.0 | |
| 42 x 16 | 250 | 1.28 | .70 | 31.0 | 27.5 | 1715 | 1.28 | .70 | 56.5 | 53.0 | |
| 42 x 18 | 250 | 1.28 | .75 | 31.0 | 27.5 | 1755 | 1.28 | .75 | 56.5 | 53.0 | |
| 42 x 20 | 250 | 1.28 | .80 | 31.0 | 27.5 | 1895 | 1.28 | .80 | 56.5 | 53.0 | |
| 42 x 24 | 250 | 1.28 | .89 | 31.0 | 27.5 | 1980 | 1.28 | .89 | 56.5 | 53.0 | |
| 42 x 30 | 250 | 1.28 | 1.03 | 31.0 | 27.5 | 2345 | 1.28 | 1.03 | 56.5 | 53.0 | |
| 42 x 36 | 250 | 1.28 | 1.15 | 31.0 | 27.5 | 3390 | 1.28 | 1.15 | 56.5 | 53.0 | 4270 |
| 48 x 12 | 250 | 1.42 | .75 | 34.0 | 30.5 | 2175 | 1.42 | .75 | 64.0 | 60.5 | 5331 |
| 48 x 14 | 250 | 1.42 | .66 | 34.0 | 30.5 | 2195 | 1.42 | .66 | 64.0 | 60.5 | |
| 48 x 16 | 250 | 1.42 | .70 | 34.0 | 30.5 | 2235 | 1.42 | .70 | 64.0 | 60.5 | |
| 48 x 18 | 250 | 1.42 | .75 | 34.0 | 30.5 | 2275 | 1.42 | .75 | 64.0 | 60.5 | |
| 48 x 20 | 250 | 1.42 | .80 | 34.0 | 30.5 | 2340 | 1.42 | .80 | 64.0 | 60.5 | |
| 48 x 24 | 250 | 1.42 | .89 | 34.0 | 30.5 | 3240 | 1.42 | .89 | 64.0 | 60.5 | |
| 48 x 30 | 250 | 1.42 | 1.03 | 34.0 | 30.5 | 3600 | 1.42 | 1.03 | 64.0 | 60.5 | |
| 48 x 36 | 250 | 1.42 | 1.15 | 34.0 | 30.5 | 3255 | 1.42 | 1.15 | 64.0 | 60.5 | |
| 48 x 42 | 250 | 1.42 | 1.28 | 34.0 | 30.5 | 4685 | 1.42 | 1.28 | 64.0 | 60.5 | |

30" and 36" reducing bends can be furnished with any combination of Flanged, MJ, Fastite, or Flex-Ring joints.

42" and 48" reducing bends can be furnished with any combination of Flanged, MJ, Fastite, or Lok-Ring joints.

The short radius reducing bends have center-to-face and radius dimensions according to AWWA C110 (same as ANSI B16.1 Class 125) based on a standard 90° bend of the larger opening. The dimensions for the long radius reducing bends are per B16.1 Class 125 based on a standard long radius 90° bend of the larger opening.

See General Notes on page 6-2.



AMERICAN Ductile Iron Flanged Fittings
 ANSI/AWWA C110/A21.10 or C153/A21.53
Flanged 45°, 22 1/2° and 11 1/4° Bends

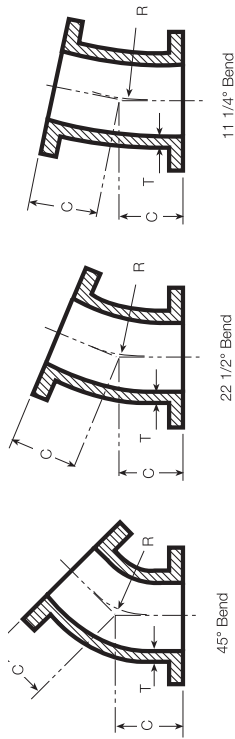

11 1/4° Bend

22 1/2° Bend

45° Bend

Table No. 6-5

| Size in. | Pressure Rating psi | T in. | 45° Bend | | 22 1/2° Bend | | 11 1/4° Bend | |
|-------------|---------------------------|----------|----------|----------|--------------|----------|--------------|----------|
| | | | C in. | R in. | C in. | R in. | C in. | R in. |
| 4 | 250 | .52 | 4.0 | 4.81 | 4.0 | 10.06 | 4.0 | 20.31 |
| 6 | 250 | .55 | 5.0 | 7.25 | 5.0 | 15.06 | 5.0 | 30.50 |
| 8 | 250 | .60 | 5.5 | 8.44 | 5.5 | 17.62 | 5.5 | 35.50 |
| 10 | 250 | .68 | 6.5 | 10.88 | 6.5 | 22.62 | 6.5 | 45.69 |
| 12 | 250 | .75 | 7.5 | 13.25 | 7.5 | 27.62 | 7.5 | 55.81 |
| 14 | 250 | .66 | 7.5 | 12.06 | 7.5 | 25.12 | 7.5 | 50.75 |
| 16 | 250 | .70 | 8.0 | 13.25 | 8.0 | 27.62 | 8.0 | 55.81 |
| 18 | 250 | .75 | 8.5 | 14.50 | 8.5 | 30.19 | 8.5 | 60.94 |
| 20 | 250 | .80 | 9.5 | 16.88 | 9.5 | 35.19 | 9.5 | 71.06 |
| 24 | 250 | .89 | 11.0 | 18.12 | 11.0 | 37.69 | 11.0 | 76.12 |
| 30 | 250 | 1.03 | 15.0 | 27.75 | 15.0 | 57.81 | 15.0 | 116.75 |
| 36 | 250 | 1.15 | 18.0 | 35.00 | 18.0 | 72.88 | 18.0 | 147.25 |
| 42 | 250 | 1.28 | 21.0 | 42.25 | 21.0 | 88.00 | 21.0 | 177.69 |
| 48 | 250 | 1.42 | 24.0 | 49.50 | 24.0 | 103.06 | 24.0 | 208.12 |
| 54 | 250* | .90 | 20.5 | 42.32 | 14.0 | 37.65 | 12.0 | 38.07 |
| 60 | 250* | .94 | 23.5 | 44.08 | 14.0 | 38.36 | 10.5 | 40.61 |
| 64 | 250* | .99 | 25.0 | 45.85 | 13.5 | 39.06 | 9.5 | 38.07 |
| | | | | 5105 | | 3995 | | 3585 |

*AMERICAN standard 54"-64" fittings are rated only 150 psi in AWWA C153.
 See General Notes on page 6-2.



AMERICAN Ductile Iron Flanged Fittings
ANSI/AWWA C110/A21.10 or C153/A21.53
Flanged Tees and Crosses

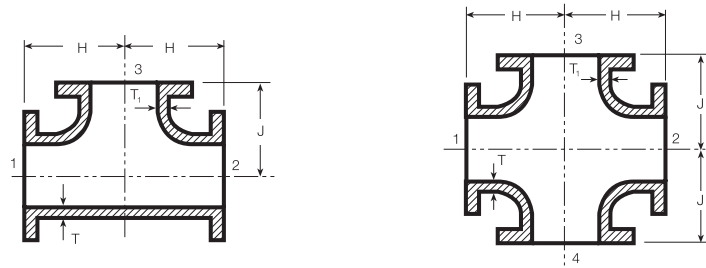

Table No. 6-6

| Size in. | | Pressure Rating psi | Dimensions in Inches | | | | Weight in Pounds | |
|----------|--------|---------------------|----------------------|----------------|------|------|------------------|-------|
| Run | Branch | | T | T ₁ | H | J | Tee | Cross |
| 4 | 4 | 250 | .52 | .52 | 6.5 | 6.5 | 65 | 85 |
| 6 | 4 | 250 | .55 | .52 | 8.0 | 8.0 | 100 | 115 |
| 6 | 6 | 250 | .55 | .55 | 8.0 | 8.0 | 105 | 130 |
| 8 | 4 | 250 | .60 | .52 | 9.0 | 9.0 | 145 | 165 |
| 8 | 6 | 250 | .60 | .55 | 9.0 | 9.0 | 150 | 175 |
| 8 | 8 | 250 | .60 | .60 | 9.0 | 9.0 | 165 | 205 |
| 10 | 4 | 250 | .68 | .52 | 11.0 | 11.0 | 220 | 240 |
| 10 | 6 | 250 | .68 | .55 | 11.0 | 11.0 | 230 | 255 |
| 10 | 8 | 250 | .68 | .60 | 11.0 | 11.0 | 240 | 280 |
| 10 | 10 | 250 | .80 | .80 | 11.0 | 11.0 | 285 | 345 |
| 12 | 4 | 250 | .75 | .52 | 12.0 | 12.0 | 315 | 335 |
| 12 | 6 | 250 | .75 | .55 | 12.0 | 12.0 | 320 | 345 |
| 12 | 8 | 250 | .75 | .60 | 12.0 | 12.0 | 335 | 370 |
| 12 | 10 | 250 | .87 | .80 | 12.0 | 12.0 | 380 | 435 |
| 12 | 12 | 250 | .87 | .87 | 12.0 | 12.0 | 405 | 490 |
| 14 | 4 | 250 | .66 | .52 | 14.0 | 14.0 | 375 | — |
| 14 | 6 | 250 | .66 | .55 | 14.0 | 14.0 | 385 | 415 |
| 14 | 8 | 250 | .66 | .60 | 14.0 | 14.0 | 400 | 445 |
| 14 | 10 | 250 | .66 | .68 | 14.0 | 14.0 | 415 | 480 |
| 14 | 12 | 250 | .66 | .75 | 14.0 | 14.0 | 445 | 535 |
| 14 | 14 | 250 | .66 | .66 | 14.0 | 14.0 | 455 | 550 |
| 16 | 4 | 250 | .70 | .52 | 15.0 | 15.0 | 475 | — |
| 16 | 6 | 250 | .70 | .55 | 15.0 | 15.0 | 485 | 515 |
| 16 | 8 | 250 | .70 | .60 | 15.0 | 15.0 | 500 | 540 |
| 16 | 10 | 250 | .70 | .68 | 15.0 | 15.0 | 515 | 575 |
| 16 | 12 | 250 | .70 | .75 | 15.0 | 15.0 | 540 | 630 |
| 16 | 14 | 250 | .70 | .66 | 15.0 | 15.0 | 550 | 645 |
| 16 | 16 | 250 | .70 | .70 | 15.0 | 15.0 | 575 | 690 |

See notes at end of Table.



AMERICAN Ductile Iron Flanged Fittings
ANSI/AWWA C110/A21.10 or C153/A21.53
Flanged Tees and Crosses

Table No. 6-6 —Continued

| Size in. | | Pressure Rating psi | Dimensions in Inches | | | | Weight in Pounds | |
|----------|--------|---------------------|----------------------|----------------|------|------|------------------|-------|
| Run | Branch | | T | T ₁ | H | J | Tee | Cross |
| 18 | 6 | 250 | .75 | .55 | 13.0 | 15.5 | 500 | 530 |
| 18 | 8 | 250 | .75 | .60 | 13.0 | 15.5 | 515 | 555 |
| 18 | 10 | 250 | .75 | .68 | 13.0 | 15.5 | 530 | 585 |
| 18 | 12 | 250 | .75 | .75 | 13.0 | 15.5 | 555 | 630 |
| 18 | 14 | 250 | .75 | .66 | 16.5 | 16.5 | 655 | 750 |
| 18 | 16 | 250 | .75 | .70 | 16.5 | 16.5 | 675 | 795 |
| 18 | 18 | 250 | .75 | .75 | 16.5 | 16.5 | 695 | 825 |
| 20 | 4 | 250 | .80 | .52 | 14.0 | 17.0 | 625 | 660 |
| 20 | 6 | 250 | .80 | .55 | 14.0 | 17.0 | 630 | 660 |
| 20 | 8 | 250 | .80 | .60 | 14.0 | 17.0 | 645 | 685 |
| 20 | 10 | 250 | .80 | .68 | 14.0 | 17.0 | 660 | 715 |
| 20 | 12 | 250 | .80 | .75 | 14.0 | 17.0 | 685 | 765 |
| 20 | 14 | 250 | .80 | .66 | 14.0 | 17.0 | 690 | 775 |
| 20 | 16 | 250 | .80 | .70 | 18.0 | 18.0 | 840 | 955 |
| 20 | 18 | 250 | .80 | .75 | 18.0 | 18.0 | 850 | 980 |
| 20 | 20 | 250 | .80 | .80 | 18.0 | 18.0 | 885 | 1055 |
| 24 | 4 | 250 | .89 | .52 | 15.0 | 19.0 | 875 | 905 |
| 24 | 6 | 250 | .89 | .55 | 15.0 | 19.0 | 880 | 905 |
| 24 | 8 | 250 | .89 | .60 | 15.0 | 19.0 | 890 | 930 |
| 24 | 10 | 250 | .89 | .68 | 15.0 | 19.0 | 905 | 960 |
| 24 | 12 | 250 | .89 | .75 | 15.0 | 19.0 | 930 | 1005 |
| 24 | 14 | 250 | .89 | .66 | 15.0 | 19.0 | 930 | 1010 |
| 24 | 16 | 250 | .89 | .70 | 15.0 | 19.0 | 950 | 1050 |
| 24 | 18 | 250 | .89 | .75 | 22.0 | 22.0 | 1270 | 1415 |
| 24 | 20 | 250 | .89 | .80 | 22.0 | 22.0 | 1305 | 1485 |
| 24 | 24 | 250 | .89 | .89 | 22.0 | 22.0 | 1380 | 1630 |
| 30 | 12 | 250 | 1.03 | .75 | 18.0 | 23.0 | 1485 | 1565 |
| 30 | 14 | 250 | 1.03 | .66 | 18.0 | 23.0 | 1490 | 1570 |
| 30 | 16 | 250 | 1.03 | .70 | 18.0 | 23.0 | 1505 | 1605 |
| 30 | 18 | 250 | 1.03 | .75 | 18.0 | 23.0 | 1515 | 1615 |
| 30 | 20 | 250 | 1.03 | .80 | 18.0 | 23.0 | 1540 | 1670 |
| 30 | 24 | 250 | 1.03 | .89 | 25.0 | 25.0 | 2025 | 2245 |
| 30 | 30 | 250 | 1.03 | 1.03 | 25.0 | 25.0 | 2150 | 2500 |
| 36 | 6 | 250 | 1.15 | .55 | 20.0 | 26.0 | 2130 | 2245 |
| 36 | 8 | 250 | 1.15 | .60 | 20.0 | 26.0 | 2140 | 2245 |
| 36 | 12 | 250 | 1.15 | .75 | 20.0 | 26.0 | 2170 | 2245 |
| 36 | 14 | 250 | 1.15 | .66 | 20.0 | 26.0 | 2175 | 2245 |
| 36 | 16 | 250 | 1.15 | .70 | 20.0 | 26.0 | 2185 | 2275 |
| 36 | 18 | 250 | 1.15 | .75 | 20.0 | 26.0 | 2190 | 2280 |
| 36 | 20 | 250 | 1.15 | .80 | 20.0 | 26.0 | 2215 | 2325 |
| 36 | 24 | 250 | 1.15 | .89 | 20.0 | 26.0 | 2255 | 2410 |
| 36 | 30 | 250 | 1.15 | 1.03 | 28.0 | 28.0 | 3000 | 3300 |
| 36 | 36 | 250 | 1.15 | 1.15 | 28.0 | 28.0 | 3165 | 3625 |

See notes at end of Table.



AMERICAN Ductile Iron Flanged Fittings
ANSI/AWWA C110/A21.10 or C153/A21.53
Flanged Tees and Crosses

Table No. 6-6 —Continued

| Size in. | | Pressure Rating psi | Dimensions in Inches | | | | Weight in Pounds | |
|----------|--------|---------------------|----------------------|----------------|------|------|------------------|-------|
| Run | Branch | | T | T ₁ | H | J | Tee | Cross |
| 42 | 12 | 250 | 1.28 | .75 | 23.0 | 30.0 | 3165 | 3240 |
| 42 | 14 | 250 | 1.28 | .66 | 23.0 | 30.0 | 3165 | 3240 |
| 42 | 16 | 250 | 1.28 | .70 | 23.0 | 30.0 | 3180 | 3270 |
| 42 | 18 | 250 | 1.28 | .75 | 23.0 | 30.0 | 3185 | 3275 |
| 42 | 20 | 250 | 1.28 | .80 | 23.0 | 30.0 | 3205 | 3320 |
| 42 | 24 | 250 | 1.28 | .89 | 23.0 | 30.0 | 3245 | 3395 |
| 42 | 30 | 250 | 1.28 | 1.03 | 31.0 | 31.0 | 4130 | 4390 |
| 42 | 36 | 150 | 1.28 | 1.15 | 31.0 | 31.0 | 4265 | 4655 |
| 42 | 36 | 250 | 1.78 | 1.58 | 31.0 | 31.0 | 5365 | 5725 |
| 42 | 42 | 150 | 1.28 | 1.28 | 31.0 | 31.0 | 4465 | 5060 |
| 42 | 42 | 250 | 1.78 | 1.78 | 31.0 | 31.0 | 5580 | 6160 |
| 48 | 12 | 250 | 1.42 | .75 | 26.0 | 34.0 | 4315 | 4395 |
| 48 | 14 | 250 | 1.42 | .66 | 26.0 | 34.0 | 4315 | 4390 |
| 48 | 16 | 250 | 1.42 | .70 | 26.0 | 34.0 | 4325 | 4415 |
| 48 | 18 | 250 | 1.42 | .75 | 26.0 | 34.0 | 4330 | 4420 |
| 48 | 20 | 250 | 1.42 | .80 | 26.0 | 34.0 | 4350 | 4460 |
| 48 | 24 | 250 | 1.42 | .89 | 26.0 | 34.0 | 4385 | 4530 |
| 48 | 30 | 250 | 1.42 | 1.03 | 26.0 | 34.0 | 4455 | 4675 |
| 48 | 36 | 250 | 1.42 | 1.15 | 34.0 | 34.0 | 5555 | 5880 |
| 48 | 42 | 150 | 1.42 | 1.28 | 34.0 | 34.0 | 5720 | 6210 |
| 48 | 42 | 250 | 1.96 | 1.78 | 34.0 | 34.0 | 7195 | 7635 |
| 48 | 48 | 150 | 1.42 | 1.42 | 34.0 | 34.0 | 5900 | 6570 |
| 48 | 48 | 250 | 1.96 | 1.96 | 34.0 | 34.0 | 7380 | 8005 |
| 54 | 36 | 250** | 1.05 | 1.15 | 31.0 | 37.0 | 4850 | 5260 |
| 54 | 42 | 250** | 1.05 | 1.28 | 39.0 | 39.0 | 5980 | 6685 |
| 54 | 48 | 250** | 1.05 | 1.42 | 39.0 | 39.0 | 6210 | 7150 |
| 54 | 54 | 250** | 1.05 | 1.05 | 39.0 | 39.0 | 6025 | 6780 |
| 60 | 36 | 250** | 1.10 | 1.15 | 33.0 | 42.0 | 6200 | — |
| 60 | 42 | 250** | 1.10 | 1.28 | 43.0 | 43.0 | 7640 | — |
| 60 | 48 | 250** | 1.10 | 1.42 | 43.0 | 43.0 | 7880 | — |
| 60 | 54 | 250** | 1.10 | 1.05 | 43.0 | 43.0 | 7665 | 8450 |
| 60 | 60 | 250** | 1.10 | 1.10 | 43.0 | 43.0 | 8045 | 9220 |
| 64 | 36 | 250** | 1.16 | 1.15 | 32.0 | 44.0 | 7505 | — |
| 64 | 42 | 250** | 1.16 | 1.28 | 48.0 | 45.0 | 9870 | 10600 |
| 64 | 48 | 250** | 1.16 | 1.42 | 48.0 | 45.0 | 10090 | — |
| 64 | 54 | 250** | 1.16 | 1.05 | 48.0 | 46.0 | 9915 | — |
| 64 | 60 | 250** | 1.16 | 1.10 | 48.0 | 46.0 | 10285 | — |
| 64 | 64 | 250** | 1.16 | 1.16 | 48.0 | 48.0 | 10995 | 12855 |

**AMERICAN standard 54"–64" fittings are rated only 150 psi in AWWA C153.
 Welded-on outlets are preferable in many cases to tees or crosses, especially for branch reductions.
 Check AMERICAN or see Section 7.
 See General Notes on page 6-2.



AMERICAN Ductile Iron Flanged Fittings
ANSI/AWWA C110/A21.10 or C153/A21.53
Flanged Reducers

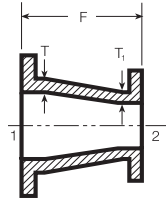

Concentric Reducer

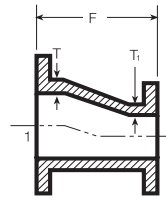

Eccentric Reducer

Table No. 6-7

| Size in. | | Pressure Rating psi | Dimensions in Inches | | | Weight lb |
|-----------|-----------|---------------------|----------------------|----------------|----|-----------|
| Large End | Small End | | T | T ₁ | F | |
| 6 | 4 | 250 | .55 | .52 | 9 | 45 |
| 8 | 4 | 250 | .60 | .52 | 11 | 65 |
| 8 | 6 | 250 | .60 | .55 | 11 | 75 |
| 10 | 4 | 250 | .68 | .52 | 12 | 85 |
| 10 | 6 | 250 | .68 | .55 | 12 | 95 |
| 10 | 8 | 250 | .68 | .60 | 12 | 110 |
| 12 | 4 | 250 | .75 | .52 | 14 | 120 |
| 12 | 6 | 250 | .75 | .55 | 14 | 130 |
| 12 | 8 | 250 | .75 | .60 | 14 | 145 |
| 12 | 10 | 250 | .75 | .68 | 14 | 165 |
| 14 | 6 | 250 | .66 | .55 | 16 | 155 |
| 14 | 8 | 250 | .66 | .60 | 16 | 170 |
| 14 | 10 | 250 | .66 | .68 | 16 | 195 |
| 14 | 12 | 250 | .66 | .75 | 16 | 225 |
| 16 | 6 | 250 | .70 | .55 | 18 | 190 |
| 16 | 8 | 250 | .70 | .60 | 18 | 210 |
| 16 | 10 | 250 | .70 | .68 | 18 | 235 |
| 16 | 12 | 250 | .70 | .75 | 18 | 265 |
| 16 | 14 | 250 | .70 | .66 | 18 | 280 |
| 18 | 6 | 250 | .75 | .55 | 19 | 220 |
| 18 | 8 | 250 | .75 | .60 | 19 | 240 |
| 18 | 10 | 250 | .75 | .68 | 19 | 265 |
| 18 | 12 | 250 | .75 | .75 | 19 | 295 |
| 18 | 14 | 250 | .75 | .66 | 19 | 305 |
| 18 | 16 | 250 | .75 | .70 | 19 | 335 |
| 20 | 6 | 250 | .80 | .55 | 20 | 265 |
| 20 | 8 | 250 | .80 | .60 | 20 | 285 |
| 20 | 10 | 250 | .80 | .68 | 20 | 310 |
| 20 | 12 | 250 | .80 | .75 | 20 | 345 |
| 20 | 14 | 250 | .80 | .66 | 20 | 355 |
| 20 | 16 | 250 | .80 | .70 | 20 | 385 |
| 20 | 18 | 250 | .80 | .75 | 20 | 410 |
| 24 | 8 | 250 | .89 | .60 | 24 | 410 |
| 24 | 10 | 250 | .89 | .68 | 24 | 440 |
| 24 | 12 | 250 | .89 | .75 | 24 | 480 |
| 24 | 14 | 250 | .89 | .66 | 24 | 490 |
| 24 | 16 | 250 | .89 | .70 | 24 | 525 |
| 24 | 18 | 250 | .89 | .75 | 24 | 550 |
| 24 | 20 | 250 | .89 | .80 | 24 | 595 |

Numerals on cuts indicate standard order of specifying size of fitting.
 See notes at end of Table.



AMERICAN Ductile Iron Flanged Fittings
ANSI/AWWA C110/A21.10 or C153/A21.53
Flanged Reducers

Table No. 6-7—Continued

| Size in. | | Pressure Rating psi | Dimensions in Inches | | | Weight lb |
|-----------|-----------|---------------------|----------------------|----------------|----|-----------|
| Large End | Small End | | T | T ₁ | F | |
| 30 | 12 | 250 | 1.03 | .75 | 30 | 730 |
| 30 | 16 | 250 | 1.03 | .66 | 30 | 735 |
| 30 | 18 | 250 | 1.03 | .75 | 30 | 815 |
| 30 | 20 | 250 | 1.03 | .80 | 30 | 865 |
| 30 | 24 | 250 | 1.03 | .89 | 30 | 965 |
| 36 | 16 | 250 | 1.15 | .70 | 36 | 1115 |
| 36 | 18 | 250 | 1.15 | .75 | 36 | 1160 |
| 36 | 20 | 250 | 1.15 | .80 | 36 | 1225 |
| 36 | 24 | 250 | 1.15 | .89 | 36 | 1340 |
| 36 | 30 | 250 | 1.15 | 1.03 | 36 | 1550 |
| 42 | 24 | 250 | 1.28 | .89 | 42 | 1810 |
| 42 | 30 | 250 | 1.28 | 1.03 | 42 | 2060 |
| 42 | 36 | 250 | 1.28 | 1.15 | 42 | 2345 |
| 48 | 30 | 250 | 1.42 | 1.03 | 48 | 2615 |
| 48 | 36 | 250 | 1.42 | 1.15 | 48 | 2940 |
| 48 | 42 | 250 | 1.42 | 1.28 | 48 | 3320 |
| 54 | 42 | 250** | .90 | 1.25 | 25 | 2025 |
| 54 | 48 | 250** | .90 | 1.40 | 18 | 1915 |
| 60 | 48 | 250** | .94 | 1.40 | 20 | 2360 |
| 60 | 54 | 250** | .94 | .90 | 15 | 2055 |
| 64 | 54 | 250** | .99 | .90 | 18 | 2695 |
| 64 | 60 | 250** | .99 | .94 | 17 | 2980 |

**AMERICAN standard 54"-64" fittings are rated for only 150 psi in AWWA C153.
 Numerals on cuts indicate standard order of specifying size of fitting.

The dimensions and weights of concentric and eccentric reducers are normally the same. If the order does not specify an eccentric reducer, then a concentric reducer will be furnished. Eccentric reducers are available in most of the sizes listed. Eccentric reducers are not available 54" and larger.



AMERICAN Ductile Iron Flanged Fittings
ANSI/AWWA C110/A21.10 or C153/A21.53
Flanged Reducers

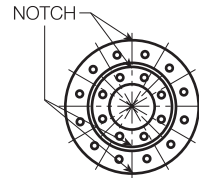

CAUTION: When Installing Flanged Reducers—

The two flanges on most reducers have a different number of bolt holes, and all adjacent bolt holes do not straddle a centerline common to both flanges.

The centerline of the reducer is marked by notches on the circumference of each flange, and installation must be made in reference to this centerline. This would also be applicable with most reducing flanges and reducing flange fillers.



AMERICAN Ductile Iron Flanged Fittings
AMERICAN Standard
Flanged Wyes — 45° Lateral

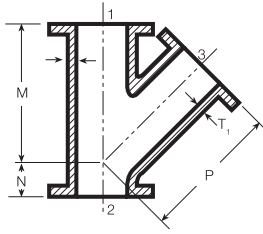

Table No. 6-8

| Size in. | | Pressure Rating psi | Dimensions in Inches | | | | | Weight lb |
|----------|--------|---------------------|----------------------|----------------|------|-----|------|-----------|
| Run | Branch | | T | T ₁ | M | N | P | |
| 4 | 4 | 250 | .52 | .52 | 12.0 | 3.0 | 12.0 | 80 |
| 6 | 4 | 250 | .55 | .52 | 14.5 | 3.5 | 14.5 | 115 |
| 6 | 6 | 250 | .55 | .55 | 14.5 | 3.5 | 14.5 | 125 |
| 8 | 4 | 250 | .60 | .52 | 17.5 | 4.5 | 17.5 | 180 |
| 8 | 6 | 250 | .60 | .55 | 17.5 | 4.5 | 17.5 | 190 |
| 8 | 8 | 250 | .60 | .60 | 17.5 | 4.5 | 17.5 | 215 |
| 10 | 4 | 250 | .68 | .52 | 20.5 | 5.0 | 20.5 | 260 |
| 10 | 6 | 250 | .68 | .55 | 20.5 | 5.0 | 20.5 | 270 |
| 10 | 8 | 250 | .68 | .60 | 20.5 | 5.0 | 20.5 | 295 |
| 10 | 10 | 250 | .68 | .68 | 20.5 | 5.0 | 20.5 | 325 |
| 12 | 4 | 250 | .75 | .52 | 24.5 | 5.5 | 24.5 | 380 |
| 12 | 6 | 250 | .75 | .55 | 24.5 | 5.5 | 24.5 | 395 |
| 12 | 8 | 250 | .75 | .60 | 24.5 | 5.5 | 24.5 | 420 |
| 12 | 10 | 250 | .75 | .68 | 24.5 | 5.5 | 24.5 | 455 |
| 12 | 12 | 250 | .75 | .75 | 24.5 | 5.5 | 24.5 | 495 |
| 14 | 6 | 250 | .82 | .55 | 27.0 | 6.0 | 27.0 | 520 |
| 14 | 8 | 250 | .82 | .60 | 27.0 | 6.0 | 27.0 | 545 |
| 14 | 10 | 250 | .82 | .68 | 27.0 | 6.0 | 27.0 | 580 |
| 14 | 12 | 250 | .82 | .75 | 27.0 | 6.0 | 27.0 | 620 |
| 14 | 14 | 250 | .82 | .82 | 27.0 | 6.0 | 27.0 | 665 |
| 16 | 6 | 250 | .89 | .55 | 30.0 | 6.5 | 30.0 | 680 |
| 16 | 8 | 250 | .89 | .60 | 30.0 | 6.5 | 30.0 | 710 |
| 16 | 10 | 250 | .89 | .68 | 30.0 | 6.5 | 30.0 | 740 |
| 16 | 12 | 250 | .89 | .75 | 30.0 | 6.5 | 30.0 | 785 |
| 16 | 14 | 250 | .89 | .82 | 30.0 | 6.5 | 30.0 | 830 |
| 16 | 16 | 250 | .89 | .89 | 30.0 | 6.5 | 30.0 | 885 |
| 18 | 4 | 250 | .96 | .52 | 25.0 | 1.0 | 27.5 | 275 |
| 18 | 6 | 250 | .96 | .55 | 32.0 | 7.0 | 32.0 | 450 |
| 18 | 8 | 250 | .96 | .60 | 32.0 | 7.0 | 32.0 | 625 |
| 18 | 10 | 250 | .96 | .68 | 32.0 | 7.0 | 32.0 | 885 |
| 18 | 12 | 250 | .96 | .75 | 32.0 | 7.0 | 32.0 | 930 |
| 18 | 14 | 250 | .96 | .82 | 32.0 | 7.0 | 32.0 | 975 |
| 18 | 16 | 250 | .96 | .89 | 32.0 | 7.0 | 32.0 | 1025 |
| 18 | 18 | 250 | .96 | .96 | 32.0 | 7.0 | 32.0 | 1075 |

Numerals on cuts indicate standard order of specifying size of fitting.
 See General Notes on page 6-2.
 Note that numbering sequence for wye ends differs from that shown in ANSI B16.1.



AMERICAN Ductile Iron Flanged Fittings
AMERICAN Standard
Flanged Wyes — 45° Lateral

Table No. 6-8—Continued

| Size in. | | Pressure Rating psi | Dimensions in Inches | | | | | Weight lb |
|----------|--------|---------------------|----------------------|----------------|------|------|------|-----------|
| Run | Branch | | T | T ₁ | M | N | P | |
| 20 | 8 | 250 | 1.03 | .60 | 29.0 | 1.0 | 29.5 | 740 |
| 20 | 10 | 250 | 1.03 | .68 | 35.0 | 8.0 | 35.0 | 805 |
| 20 | 12 | 250 | 1.03 | .75 | 35.0 | 8.0 | 35.0 | 1170 |
| 20 | 14 | 250 | 1.03 | .82 | 35.0 | 8.0 | 35.0 | 1215 |
| 20 | 16 | 250 | 1.03 | .89 | 35.0 | 8.0 | 35.0 | 1270 |
| 20 | 18 | 250 | 1.03 | .96 | 35.0 | 8.0 | 35.0 | 1315 |
| 20 | 20 | 250 | 1.03 | 1.03 | 35.0 | 8.0 | 35.0 | 1390 |
| 24 | 6 | 250 | 1.16 | .55 | 31.5 | 0.5 | 34.5 | 1060 |
| 24 | 8 | 250 | 1.16 | .60 | 40.5 | 9.0 | 40.5 | 1080 |
| 24 | 10 | 250 | 1.16 | .68 | 40.5 | 9.0 | 40.5 | 1105 |
| 24 | 12 | 250 | 1.16 | .75 | 40.5 | 9.0 | 40.5 | 1200 |
| 24 | 14 | 250 | 1.16 | .82 | 40.5 | 9.0 | 40.5 | 1750 |
| 24 | 16 | 250 | 1.16 | .89 | 40.5 | 9.0 | 40.5 | 1805 |
| 24 | 18 | 250 | 1.16 | .96 | 40.5 | 9.0 | 40.5 | 1855 |
| 24 | 20 | 250 | 1.16 | 1.03 | 40.5 | 9.0 | 40.5 | 1930 |
| 24 | 24 | 250 | 1.16 | 1.16 | 40.5 | 9.0 | 40.5 | 2095 |
| 30 | 12 | 250 | 1.03 | .75 | 49.0 | 10.0 | 49.0 | 2795 |
| 30 | 14 | 250 | 1.03 | .66 | 49.0 | 10.0 | 49.0 | 2850 |
| 30 | 16 | 250 | 1.37 | .89 | 49.0 | 10.0 | 49.0 | 2905 |
| 30 | 18 | 250 | 1.37 | .96 | 49.0 | 10.0 | 49.0 | 2960 |
| 30 | 20 | 250 | 1.37 | 1.03 | 49.0 | 10.0 | 49.0 | 3040 |
| 30 | 24 | 250 | 1.37 | 1.16 | 49.0 | 10.0 | 49.0 | 3205 |
| 30 | 30 | 250 | 1.37 | 1.37 | 52.5 | 18.3 | 52.5 | 4125 |
| 36 | 12 | 250 | 1.15 | .75 | 60.0 | 19.5 | 60.0 | 4490 |
| 36 | 14 | 250 | 1.15 | .66 | 60.0 | 19.5 | 60.0 | 4505 |
| 36 | 16 | 250 | 1.58 | .89 | 54.0 | 15.3 | 54.0 | 4455 |
| 36 | 18 | 250 | 1.58 | .96 | 54.0 | 15.3 | 54.0 | 4505 |
| 36 | 20 | 250 | 1.58 | 1.03 | 54.0 | 15.3 | 54.0 | 4575 |
| 36 | 24 | 250 | 1.58 | 1.16 | 54.0 | 15.3 | 54.0 | 4725 |
| 36 | 30 | 250 | 1.58 | 1.37 | 56.0 | 15.3 | 56.0 | 5200 |
| 36 | 36 | 250 | 1.58 | 1.58 | 60.0 | 19.5 | 60.0 | 6310 |
| 42 | 12 | 250 | 1.28 | .75 | 68.5 | 21.0 | 68.5 | 5725 |
| 42 | 14 | 250 | 1.28 | .66 | 68.5 | 21.0 | 68.5 | 5800 |
| 42 | 16 | 150 | 1.28 | .70 | 68.5 | 21.0 | 68.5 | 5850 |
| 42 | 18 | 150 | 1.28 | .75 | 68.5 | 21.0 | 68.5 | 6000 |
| 42 | 20 | 250 | 1.28 | .80 | 60.0 | 12.0 | 60.0 | 6110 |
| 42 | 24 | 250 | 1.28 | .89 | 60.0 | 12.0 | 60.0 | 6255 |
| 42 | 30 | 250 | 1.78 | 1.37 | 63.0 | 12.0 | 63.0 | 6855 |
| 42 | 36 | 150 | 1.78 | 1.58 | 66.0 | 12.0 | 66.0 | 7650 |
| 42 | 42 | 150 | 1.78 | 1.78 | 71.0 | 15.0 | 71.0 | 9170 |
| 48 | 12 | 250 | 1.42 | .75 | 77.0 | 22.5 | 77.0 | 7200 |
| 48 | 14 | 250 | 1.42 | .66 | 77.0 | 22.5 | 77.0 | 7275 |
| 48 | 16 | 250 | 1.42 | .70 | 77.0 | 22.5 | 77.0 | 7400 |
| 48 | 18 | 150 | 1.42 | .75 | 65.0 | 9.0 | 65.0 | 7620 |
| 48 | 24 | 250 | 1.96 | 1.16 | 58.0 | 5.0 | 64.0 | 6840 |
| 48 | 30 | 250 | 1.96 | 1.37 | 63.0 | 9.0 | 68.0 | 8015 |
| 48 | 36 | 250 | 1.96 | 1.58 | 69.0 | 7.0 | 72.0 | 8970 |
| 48 | 42 | 150 | 1.96 | 1.78 | 77.0 | 12.0 | 77.0 | 11010 |
| 48 | 48 | 150 | 1.96 | 1.96 | 77.0 | 16.0 | 77.0 | 12100 |

Numerals on cuts indicate standard order of specifying size of fitting.
 Wyes are special. Substituting a pipe with a lateral welded-on outlet may be more economical and offer quicker shipment. See Section 7 or contact AMERICAN. A tee with a 45° bend may also offer quicker shipment.
 The center-to-face designations "M", "N" and "P" are used for straight size wyes as well as reducing wyes; however, in Table No. 6-2 the letters "D" and "E" are used for specifying center-to-face dimensions for straight size wyes.
 See General Notes on page 6-2.



AMERICAN Ductile Iron Flanged Fittings
AMERICAN Standard
True Wye

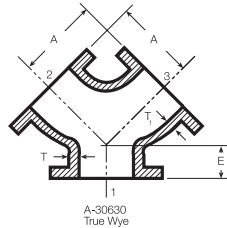

Table No. 6-9

| Size in. | | Pressure Rating psi | Dimensions in Inches | | | | Weight lb |
|----------|------------------|---------------------|----------------------|----------------|------|-----|-----------|
| Run (1) | Branch (2) & (3) | | T | T ₁ | A | E | |
| 4 | 4 | 250 | .52 | .52 | 6.5 | 3.0 | 55 |
| 6 | 6 | 250 | .55 | .55 | 8.0 | 3.5 | 85 |
| 8 | 8 | 250 | .60 | .60 | 9.0 | 4.5 | 140 |
| 10 | 8 | 250 | .68 | .60 | 9.0 | 5.0 | 155 |
| 10 | 10 | 250 | .68 | .68 | 11.0 | 5.0 | 205 |
| 12 | 8 | 250 | .75 | .60 | 9.0 | 5.5 | 210 |
| 12 | 10 | 250 | .75 | .68 | 12.0 | 5.5 | |
| 12 | 12 | 250 | .75 | .75 | 12.0 | 5.5 | 300 |
| 14 | 14 | 250 | .82 | .82 | 14.0 | 6.0 | 435 |
| 16 | 16 | 250 | .89 | .89 | 15.0 | 6.5 | 580 |
| 18 | 18 | 250 | .96 | .96 | 16.5 | 7.0 | 680 |
| 20 | 20 | 250 | 1.03 | 1.03 | 18.0 | 8.0 | 960 |
| 24 | 24 | 250 | 1.16 | 1.16 | 22.0 | 9.0 | 1370 |

*Contact AMERICAN if higher pressure ratings are required.
 Numerals on cuts indicate standard order of specifying size of fitting.
 Reducing true wyes are not available in 24" and smaller sizes.



AMERICAN Toruseal® Flange Gasket***
Full Face — 1/8" Thickness



Table No. 6-10

| Pipe Size in. | Pressure Rating* psi | Gasket Weight lb | Approximate Bolt Torque** (ft.-lb) |
|------------------|----------------------------|---------------------|--|
| 4 | 350 | .3 | 100 |
| 6 | 350 | .3 | 150 |
| 8 | 350 | .5 | 150 |
| 10 | 350 | .6 | 200 |
| 12 | 350 | .8 | 200 |
| 14 | 350 | .9 | 250 |
| 16 | 350 | 1.1 | 250 |
| 18 | 350 | 1.1 | 300 |
| 20 | 350 | 1.3 | 300 |
| 24 | 350 | 1.6 | 400 |
| 30 | 250 | 2.1 | 400 |
| 36 | 250 | 2.7 | 500 |
| 42 | 250 | 3.5 | 500 |
| 48 | 250 | 4.0 | 500 |
| 54 | 250 | 4.3 | 600 |
| 60 | 250 | 6.4 | 600 |
| 64 | 250 | 9.1 | 600 |

*Pressure rating designated is maximum water working pressure and is based on the maximum rating of C110, C115 or C153 flanges. AMERICAN Toruseal® gaskets meet the description of "specially designed gaskets" shown in the appendices of AWWA C110, C111, and C115, and "special gaskets" shown in the body of AWWA C111.

**Bolt torque applicable only to joints with Toruseal® gaskets.

AMERICAN Toruseal® gaskets are normally black and furnished of SBR rubber per ANSI/AWWA C111/A21.11. This rubber compound is NSF 61 certified for contact with potable water and is otherwise physically superior to red rubber sometimes used with flanged joints. Other types of rubber are available on special order.

Clean flange faces and faced pipe ends thoroughly prior to installation. Do not use joint or gasket compounds with Toruseal® gaskets (assemble joints dry).

In addition to normal flanged piping, AMERICAN Toruseal® gaskets are required for use with suspended joints in specially designed long-span installations (i.e., spans involving 2 or 3 lengths of pipe). See Section 7 for details.

For use with standard flange bolts. Holes match AWWA C110, C111, and C115 flange drilling. They also match certain flange drilling classes of AWWA C207 and ANSI B16.1 and B16.42 flanges.

***AMERICAN Toruseal® gaskets 1/8" thick and are supplied with dual raised torus bulbs.



AMERICAN Ductile Iron Flanged Fittings
AMERICAN Standard
Threaded Companion Flanges and Blind Flanges
F&D ANSI/AWWA C110/A21.10 or C115/A21.15



Table No. 6-11

| Size in. | O Diameter of Flange in. | Q Thickness of Flange in. | V Thickness in. | X Hub Diameter in. | Y Overall Thickness in. | Weight in Pounds | |
|----------|--------------------------|---------------------------|-----------------|--------------------|-------------------------|------------------|-------------------|
| | | | | | | Blind Flange | Companion Flange* |
| 4 | 9.00 | .94 | .88 | 5.31 | 1.31 | 14 | 12 |
| 6 | 11.00 | 1.00 | .94 | 7.56 | 1.56 | 25 | 17 |
| 8 | 13.50 | 1.12 | 1.06 | 9.69 | 1.75 | 40 | 25 |
| 10 | 16.00 | 1.19 | 1.12 | 11.94 | 1.94 | 60 | 35 |
| 12 | 19.00 | 1.25 | .81 | 14.06 | 2.19 | 80 | 55 |
| 14 | 21.00 | 1.38 | .88 | - | - | 110 | - |
| 16 | 23.50 | 1.44 | 1.00 | - | - | 145 | - |
| 18 | 25.00 | 1.56 | 1.06 | - | - | 175 | - |
| 20 | 27.50 | 1.69 | 1.12 | - | - | 225 | - |
| 24 | 32.00 | 1.88 | 1.25 | - | - | 328 | - |
| 30 | 38.75 | 2.12 | 2.32 | - | - | 703 | - |
| 36 | 46.00 | 2.38 | 2.99 | - | - | 1232 | - |
| 42 | 53.00 | 2.62 | 1.81 | - | - | 1230 | - |
| 48 | 59.50 | 2.75 | 2.00 | - | - | 1657 | - |
| 54 | 66.25 | 3.00 | 2.25 | - | - | 2249 | - |
| 60 | 73.00 | 3.12 | 2.38 | - | - | 2863 | - |
| 64 | 80.00 | 3.38 | 2.56 | - | - | 3761 | - |

*Ductile companion flanges are threaded for fabrication on standard steel pipe outside diameter unless specified otherwise.

No gray iron companion flanges are produced. Check AMERICAN if larger companion flanges are desired.

See General Notes, page 6-2, concerning 3" size.

See Section 8 for companion flanges for ductile iron pipe.

Reducing blind and companion flanges can be furnished. Specify flange outside diameter and the size of pipe.

Dished blind flanges 24" and larger are furnished with a lifting eye. The "V" thicknesses for 30" and 36" blind flanges are special manufacturing thicknesses. Flat blind flanges and blind flanges smaller than 20" may be ordered with a special, fabricated lifting eye.

Table No. 6-12 **Blind Flange Design**

| Size | Standard Design | Pressure Rating psi |
|---------|-----------------|---------------------|
| 4"-10" | Flat | 250 |
| 12"-24" | Dished | 250 |
| 30"-48" | Dished | 250 |
| 54"-64" | Dished | 150 |
| | Special Design | |
| 12"-24" | Flat | 200 |

See General Notes on page 6-2.



AMERICAN Ductile Iron Flanged Fittings
AMERICAN Standard — F&D ANSI/AWWA C110/A21.10
Flange Fillers

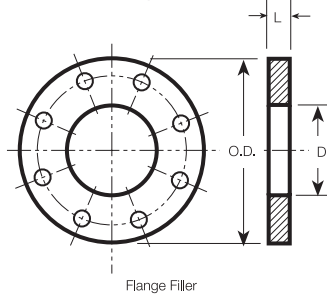

Table No. 6-13

| Size in. | | Weight in Pounds | | | | |
|-------------|-------|--------------------------|-----|-------|-----|-----|
| | | For Length (L) in Inches | | | | |
| D | O.D. | 3/4 | 1 | 1 1/2 | 2 | 3 |
| 4 | 9.00 | 9 | 12 | 19 | 25 | 37 |
| 6 | 11.00 | 12 | 16 | 24 | 32 | 48 |
| 8 | 13.50 | 17 | 23 | 34 | 46 | 69 |
| 10 | 16.00 | 22 | 29 | 44 | 59 | 88 |
| 12 | 19.00 | 31 | 42 | 63 | 84 | 126 |
| 14 | 21.00 | 35 | 47 | 70 | 94 | 141 |
| 16 | 23.50 | 42 | 56 | 85 | 113 | 169 |
| 18 | 25.00 | 42 | 56 | 85 | 113 | 169 |
| 20 | 27.50 | 50 | 66 | 100 | 133 | 199 |
| 24 | 32.00 | 63 | 84 | 126 | 163 | 251 |
| 30 | 38.75 | 84 | 112 | 168 | 224 | 336 |
| 36 | 46.00 | 113 | 150 | 225 | 300 | 451 |
| 42 | 53.00 | 145 | 194 | 291 | 388 | 582 |
| 48 | 59.50 | 172 | 229 | 343 | 457 | 686 |
| 54 | 66.25 | 169 | 225 | 338 | 451 | 676 |
| 60 | 73.00 | 238 | 317 | 476 | 634 | 952 |

Other thicknesses and certain beveled flange fillers may be available upon request. Contact AMERICAN for details.

Beveled flange fillers can be furnished. 4"-12" are available for 1/2" to 2 1/2" with 2" max. bevel. 14"-64" are available for 1/2" to 4" with 3 1/2" max. bevel. Although a wide range of bevel filler thicknesses are available, certain bevel filler thicknesses are limited by bolt clearance problems. Check AMERICAN for all bevel filler applications.

See General Notes on page 6-2.



AMERICAN Ductile Iron Flanged Fittings ANSI/AWWA C110/A21.10 and AMERICAN Standard Flanged Base 90° Bends

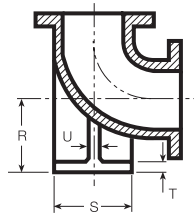

Short Radius
AWWA C110

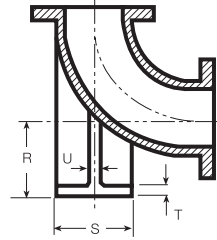

Long Radius
AMERICAN Standard

Table No. 6-14

| Size in. | Pressure Rating psi | Dimensions in Inches | | | | Weight in Pounds | | | |
|-------------|---------------------------|----------------------|-----------|------|------|------------------|--------------|--------------|--------------|
| | | R | S Dia. | T | U | Short Radius | | Long Radius | |
| | | | | | | Base Bend | Base Only | Base Bend | Base Only |
| 4 | 250 | 5.50 | 6.00 | .62 | .50 | 55 | 10 | 65 | 15 |
| 6 | 250 | 7.00 | 7.00 | .69 | .62 | 85 | 20 | 110 | 30 |
| 8 | 250 | 8.38 | 9.00 | .94 | .88 | 145 | 40 | 195 | 55 |
| 10 | 250 | 9.75 | 9.00 | .94 | .88 | 210 | 45 | 280 | 65 |
| 12 | 250 | 11.25 | 11.00 | 1.00 | 1.00 | 300 | 65 | 420 | 95 |
| 14 | 250 | 12.50 | 11.00 | 1.00 | 1.00 | 360 | 70 | 490 | 105 |
| 16 | 250 | 13.75 | 11.00 | 1.00 | 1.00 | 445 | 75 | 615 | 110 |
| 18 | 250 | 15.00 | 13.50 | 1.12 | 1.12 | 565 | 115 | 800 | 170 |
| 20 | 250 | 16.00 | 13.50 | 1.12 | 1.12 | 700 | 120 | 985 | 175 |
| 24 | 250 | 18.50 | 13.50 | 1.12 | 1.12 | 1030 | 130 | 1430 | 190 |
| 30 | 150 | 23.00 | 16.00 | 1.19 | 1.15 | 1625 | 190 | 2400 | 295 |
| 30 | 250 | 23.00 | 16.00 | 1.19 | 1.15 | 1625 | 190 | 2400 | 295 |
| 36 | 250 | 26.00 | 19.00 | 1.25 | 1.15 | 2385 | 250 | 3680 | 395 |
| 42 | 250 | 30.00 | 23.50 | 1.44 | 1.28 | 3465 | 410 | 5515 | 650 |
| 48 | 250 | 34.00 | 25.00 | 1.56 | 1.42 | 4610 | 515 | 7635 | 845 |
| *54 | 250 | 38.00 | 27.50 | 1.69 | 1.55 | 4790 | 1050 | - | - |
| *60 | 250 | 42.00 | 32.00 | 1.88 | 1.75 | 6465 | 1500 | - | - |
| *64 | 250 | 44.00 | 38.75 | 2.12 | 1.75 | 8995 | 2250 | - | - |

*Not included in AWWA C110 or C153.

Bases are faced and drilled only when specified. Dimension "R" is finished dimension; unfinished bases will be slightly longer. For supporting pipe sizes, see Table No. 6-22.

For base drilling, see Table No. 6-21.

See tables on preceding pages for dimensions and weights of all bends. Base dimensions and weights are the same for full opening bends and for reducing bends. Proper base is determined by largest opening. To compute total weight of reducing base bend, add weight of base only (shown above) to weight of reducing bend of size and class as selected from preceding tables. When ordering reducing base bends always specify which flange is opposite the base. Bases other than shown above—such as on the side of fitting—are special and may be available on 14" and larger bends. Some available base locations are shown on page 6-5. Check AMERICAN for special base locations.

Bases of these fittings are intended for support in compression and are not to be used for thrust anchors or supports in tension, bending, or shear.

See General Notes on page 6-2.



AMERICAN Ductile Iron Flanged Fittings
ANSI/AWWA C110/A21.10 or C153/A21.53
Flanged Base Tees

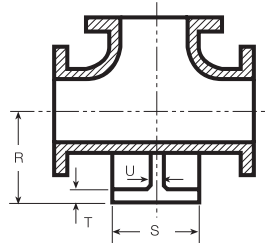

Base Tee

Table No. 6-15

| Size in. | Pressure Rating psi | Dimensions in Inches | | | | Weight in Pounds | |
|----------|---------------------|----------------------|--------|------|------|------------------|-----------|
| | | R | S Dia. | T | U | Base Fitting | Base Only |
| 4 | 250 | 5.50 | 6.00 | .62 | .50 | 75 | 10 |
| 6 | 250 | 7.00 | 7.00 | .69 | .62 | 110 | 15 |
| 8 | 250 | 8.38 | 9.00 | .94 | .88 | 185 | 30 |
| 10 | 250 | 9.75 | 9.00 | .94 | .88 | 300 | 30 |
| 12 | 250 | 11.25 | 11.00 | 1.00 | 1.00 | 430 | 45 |
| 14 | 250 | 12.50 | 11.00 | 1.00 | 1.00 | 485 | 50 |
| 16 | 250 | 13.75 | 11.00 | 1.00 | 1.00 | 600 | 50 |
| 18 | 250 | 15.00 | 13.50 | 1.12 | 1.12 | 740 | 75 |
| 20 | 250 | 16.00 | 13.50 | 1.12 | 1.12 | 930 | 75 |
| 24 | 250 | 18.50 | 13.50 | 1.12 | 1.12 | 1410 | 80 |
| 30 | 250 | 23.00 | 16.00 | 1.19 | 1.15 | 2270 | 120 |
| 36 | 250 | 26.00 | 19.00 | 1.25 | 1.15 | 3320 | 160 |
| 42 | 150 | 30.00 | 23.50 | 1.44 | 1.28 | 4740 | 270 |
| 42 | 250 | 30.00 | 23.50 | 1.44 | 1.28 | 5850 | 270 |
| 48 | 150 | 34.00 | 25.00 | 1.56 | 1.42 | 6235 | 335 |
| 48 | 250 | 34.00 | 25.00 | 1.56 | 1.42 | 7720 | 335 |
| *54 | 250 | 38.00 | 27.50 | 1.69 | 1.55 | 6590 | 565 |
| *60 | 250 | 42.00 | 32.00 | 1.88 | 1.75 | 8905 | 855 |
| *64 | 250 | 44.00 | 38.75 | 2.12 | 1.75 | 12275 | 1275 |

*Not included in AWWA C110 or C153.

Bases are faced and drilled only when specified. Dimension "R" is finished dimension; unfinished bases will be slightly longer. For supporting pipe sizes, see Table No. 6-22.

For base drilling, see Table No. 6-21.

See tables on preceding pages for dimensions and weights of all tees. Base dimensions and weights are the same for full opening tees and for reducing tees. Proper base is determined by largest opening. To compute total weight of reducing base tee, add weight of base only (shown above) to weight of reducing tee of size and class as selected from preceding tables. To order base tees reducing on the branch, specify sizes in proper order and give figure number shown above.

Bases other than shown above—such as on the side of fitting—are special and may be available on 30" and larger bends. Some available base locations are shown on page 6-5. Check AMERICAN for special base locations.

Bases of these fittings are intended for support in compression and are not to be used for thrust anchors or supports in tension, bending, or shear.

See General Notes on page 6-2.



**AMERICAN Ductile Iron Flanged Fittings
ANSI/AWWA C110/A21.10 and AMERICAN Standard
Base Flange Details**

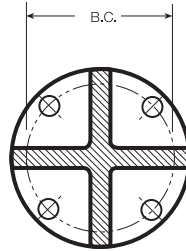

Table No. 6-16

| Fitting Size in. | Dimensions in Inches | | No. of Bolts |
|------------------|----------------------|--------------------|--------------|
| | B.C. Bolt Circle | Bolt Hole Diameter | |
| 4 | 4.75 | 3/4 | 4 |
| 6 | 5.50 | 3/4 | 4 |
| 8 | 7.50 | 3/4 | 4 |
| 10 | 7.50 | 3/4 | 4 |
| 12 | 9.50 | 7/8 | 4 |
| 14 | 9.50 | 7/8 | 4 |
| 16 | 9.50 | 7/8 | 4 |
| 18 | 11.75 | 7/8 | 4 |
| 20 | 11.75 | 7/8 | 4 |
| 24 | 11.75 | 7/8 | 4 |
| 30 | 14.25 | 1 | 4 |
| 36 | 17.00 | 1 | 4 |
| 42 | 21.25 | 1 1/8 | 4 |
| 48 | 22.75 | 1 1/4 | 4 |
| *54 | 25.00 | 1 1/4 | 4 |
| *60 | 29.50 | 1 3/8 | 4 |
| *64 | 36.00 | 1 3/8 | 4 |

*These sizes are not included in AWWA C110 or C153.
BASE FACED AND DRILLED: Bases are not faced or drilled unless so specified on the purchase order. When a base fitting is ordered with base faced and drilled, base will be plain faced and drilled as shown in the table.
 For supporting pipe sizes, see Table No. 6-22. See Table Nos. 6-19 and 6-20 for additional base dimensions.
 See General Notes on page 6-2.

Size of Supporting Flanged Pipe for Base Fittings

Table No. 6-17

| Fitting Size-Inches | 4 | 5 | 6 | 8 | 10 | 12 | 14 | 16 | 18 | 20 | 24 | 30 | 36 | 42 | 48 | 54 | 60 | 64 |
|-----------------------------|---|-------|-------|---|----|----|----|----|----|----|----|----|----|----|----|----|----|----|
| Supporting Pipe Size-Inches | 2 | 2 1/2 | 2 1/2 | 4 | 4 | 6 | 6 | 6 | 8 | 8 | 8 | 10 | 12 | 16 | 18 | 20 | 24 | 30 |

Section 7

AMERICAN Specials





AMERICAN Specials

The principal standards relating to AMERICAN Specials are ANSI/AWWA C110/A21.10, C151/A21.51, and C153/A21.53. These and other standards are referenced throughout this Section either by the full ANSI/AWWA designation or by only the AWWA numbering, such as AWWA C110.

In addition to the full complement of Mechanical Joint (MJ), Fastite®, Restrained Joint, and Flanged fittings, AMERICAN furnishes many special fittings to meet special construction requirements. AMERICAN Specials include types and lengths of wall pipe, wall castings and fabrications, fittings with a combination of joints, and a number of other special fittings. Many of the special fittings furnished by AMERICAN are included in this section.

General Notes Relating to AMERICAN Specials

1. Fittings are manufactured of ductile iron, grade 70-50-05 (minimum tensile strength: 70,000 psi; minimum yield strength: 50,000 psi; minimum elongation: 5%) in accordance with AWWA C110 or C153.
2. Pipes are manufactured of ductile iron, grade 60-42-10, (minimum tensile strength: 60,000 psi; minimum yield strength: 42,000 psi; minimum elongation: 10%) in accordance with AWWA C151.
3. Flange adaptors for AWWA C110/C115 Flange to ANSI/ASME B16.1 Class 250 Flange are manufactured of ASTM A36 steel.
4. Flanges and static-cast MJ bells can be tapped for studs when specified by the purchaser.
5. All pressure ratings shown are AMERICAN's suggested standard and are for water service.
6. Unless otherwise noted, all cast-on flanges are per AWWA C110 or C153.
7. All Mechanical Joints comply with AWWA C111. Threaded-on or otherwise fabricated MJ bells are per applicable portions of AWWA C115 and C153. Weights of MJ accessories are not included in weights of fittings with MJ outlets shown in tables, unless otherwise specified.
8. Weights of fittings can vary due to changes in foundry practice.
9. AMERICAN produces many specials other than those listed in this section. Contact AMERICAN regarding any specific requirements.



**AMERICAN Ductile Iron Specials
Plain End Pipe and Thrust Collar Weights
Fabricated Wall Pipe**

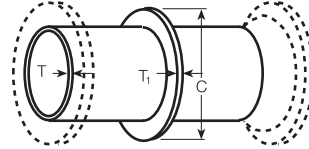

Table No. 7-1

| Size in. | Plain End Pipe | | | | Thrust Collars | | | |
|-------------|---------------------------------|-----------------|---------------------|-----------------|------------------------|----------------------|--------------|---|
| | Ductile Iron Centrifugally Cast | | | | T1 Thickness in. | C Diameter in. | Weight lb | Allowable Load † Per Collar T lbs |
| | ANSI/AWWA* Minimum Class | Weight lb/ft | ANSI/AWWA** C115 | Weight lb/ft | | | | |
| 4 | .25 | 10.9 | .32 | 13.8 | .25 | 6.80 | 1 | 4,500 |
| 6 | .25 | 16.0 | .34 | 21.4 | .25 | 8.90 | 2 | 9,300 |
| 8 | .25 | 21.1 | .36 | 30.1 | .25 | 11.05 | 2 | 16,000 |
| 10 | .26 | 27.1 | .38 | 39.2 | .25 | 13.10 | 3 | 24,000 |
| 12 | .28 | 34.8 | .40 | 49.2 | .25 | 15.20 | 3 | 34,000 |
| 14 | .28 | 40.4 | .42 | 60.1 | .25 | 17.30 | 5 | 46,000 |
| 16 | .30 | 49.3 | .43 | 70.1 | .25 | 19.40 | 6 | 59,000 |
| 18 | .31 | 57.2 | .44 | 80.6 | .38 | 22.50 | 15 | 75,000 |
| 20 | .33 | 67.5 | .45 | 91.5 | .38 | 24.60 | 11 | 92,000 |
| 24 | .33 | 80.8 | .47 | 114.4 | .38 | 28.80 | 13 | 130,000 |
| 30 | .34 | 103.5 | .51 | 154.4 | .50 | 36.00 | 29 | 200,000 |
| 36 | .38 | 138.5 | .58 | 210.3 | .50 | 42.30 | 35 | 290,000 |
| 42 | .41 | 173.8 | .65 | 274.0 | .75 | 50.75 | 98 | 390,000 |
| 48 | .46 | 222.6 | .72 | 346.6 | .75 | 57.05 | 111 | 510,000 |
| 54 | .51 | 279.7 | .81 | 441.9 | 1.00 | 66.06 | 231 | 650,000 |
| 60 | .54 | 317.0 | .83 | 485.0 | 1.00 | 70.11 | 246 | 745,000 |
| 64 | .56 | 350.5 | .87 | 542.0 | 1.00 | 74.17 | 261 | 847,000 |

*AWWA C151 – minimum thickness classes in this standard are Class 350 for 4”–12” sizes, Class 250 for 14”–20” sizes, Class 200 for 24” and Class 150 for 30”–64” sizes.

**AWWA C115 – minimum thicknesses for all sizes of ductile iron pipe for threading on flanges.

Wall pipe is normally fabricated of Special Class 53 thickness ductile iron pipe but may be furnished with minimum classes unless threaded flanges or threaded MJ bells are included or unless specified otherwise. For weights of plain end pipe of other classes see Section 3, Table No. 3–9.

†These values are based on dead-end thrust due to 250 psi internal pressure. For higher allowable loads or pressures, contact AMERICAN. (See also the figure above Table No. 9–11, for use of thrust collars, e.g., in some buried systems where other types of concrete thrust blocks cannot be used.)

Welded-on thrust collars are normally fabricated from steel. Dimensions and weights above are for steel thrust collars.

Collars may be angled and/or rotated from top dead center. Contact AMERICAN for details.

See general notes on page 7–1.



AMERICAN Ductile Iron Specials Bell and Flange Weights

Table No. 7-2

| Size in. | Bells—Weight in Pounds | | | | | Flanges—Weight in Pounds | |
|-------------|-----------------------------------|-------------------------|-----------------------------------|-----------------------------------|-----------------------------------|--------------------------|-----------------------------|
| | Mechanical Joint | | Fastite | Flex-Ring | Lok-Ring | ANSI/AWWA** Flange | ANSI B16.1 F&D Class 250 |
| | Centrifugally Cast On Pipe* | Threaded- On Pipe | Centrifugally Cast On Pipe* | Centrifugally Cast On Pipe* | Centrifugally Cast On Pipe* | Threaded- On C115 | Threaded- On |
| 4 | 14 | 16 | 7 | 14 | — | 12 | 22 |
| 6 | 19 | 23 | 12 | 20 | — | 17 | 32 |
| 8 | 25 | 31 | 19 | 29 | — | 24 | 51 |
| 10 | 31 | 41 | 29 | 40 | — | 36 | 69 |
| 12 | 38 | 55 | 31 | 54 | — | 55 | 100 |
| 14 | — | 85 | 40 | 92 | — | 70 | 125 |
| 16 | — | 105 | 45 | 105 | — | 80 | 145 |
| 18 | — | 125 | 72 | 125 | — | 85 | 200 |
| 20 | — | 150 | 80 | 130 | — | 105 | 220 |
| 24 | — | 235 | 96 | 222 | — | 160 | 335 |
| 30 | — | 375 | 164 | 328 | — | 240 | 514 |
| 36 | — | 500 | 210 | 428 | — | 350 | 697 |
| 42 | — | 600 | 315 | 609 | — | 500 | 994 |
| 48 | — | 810 | 389 | 778 | — | 625 | 1510 |
| 54 | — | — | 515 | — | 667 | 664 | — |
| 60 | — | — | 569 | — | 805 | 1055 | — |
| 64 | — | — | 677 | — | 866 | 1765 | — |

*Bell weights for ductile iron pipe are the same for all pressure classes per AWWA C151.

**AWWA C110 flange and AWWA C115 flange will match with facing and drilling of ANSI B16.1 Class 125 flange.

In sizes where applicable.

A unique Fastite fitting bell is not available in many configurations of 4"–48" fittings. In cases where Flex-Ring bell fittings are used without Flex-Ring or Field Flex-Ring restraint (in effect as "Fastite") the Flex-Ring "Statically Cast" bell weight will of course apply.

Weights shown for 14" and larger AWWA C110 cast-on flanges are for Class B thickness statically cast pipe and fittings; for a Class D thickness casting the cast-on flange weight is lighter by approximately 5% to 15% with the lower of these percentages applicable to the smaller size fittings and the higher of the percentages to the larger size fittings.

Weights above are subject to change, our option.

See General Notes on page 7-1.

To determine weight of wall pipe, use data in Table Nos. 7-1 and 7-2. For example: Weight of 12" Flg-W/S-MJ Wall Pipe with centrifugal cast bell 12" L.L.(14 1/2" O.A.) Special Class 53 equals (12"/12" X 49.2 lb/ft.) + 58 lbs (Flg) + 10 lbs (W/S) + 38 lbs (MJ Bell) = 155 lbs.



AMERICAN Ductile Iron Specials Thrust Collar (T/C) Wall Pipe - Fabricated from Centrifugally Cast Ductile Iron Pipe

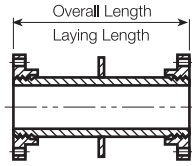

Flange-Thrust Collar-Flange

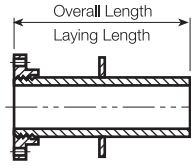

Flange-Thrust Collar-Plain End

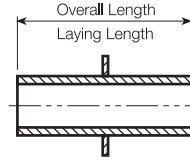

Plain End-Thrust Collar-Plain End

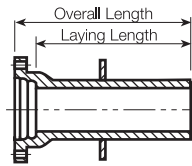

MJ-Thrust Collar-Plain End

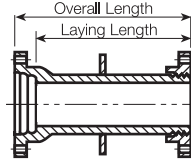

MJ-Thrust Collar-Flange

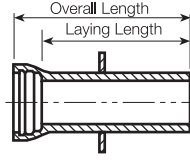

Fastite-Thrust Collar-Plain End

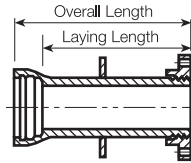

Fastite-Thrust Collar-Flange

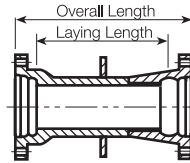

MJ-Thrust Collar-MJ Fab

Table No. 7-3

| Size in. | Minimum Dimensions in Inches | | | | | | | | | | | | | |
|----------|-------------------------------|--------------------------------|------------|------------------|-------------------------------|-----------|-------------------------------|--------------------------------|-------------------------------|-------------------------------|---------------------------------|-------------------------------|-------------------------------|--|
| | Fig-T/C-Flg. | Fig-T/C-PE | Fig-T/C-PE | MJ-T/C-MJ (Fab*) | | MJ-T/C-PE | | MJ-T/C-Flg | | Fst-T/C-PE | | Fst-T/C-Flg | | |
| | O.A./L.L. | O.A./L.L. | O.A./L.L. | O.A. | L.L. | O.A. | L.L. | O.A. | L.L. | O.A. | L.L. * | O.A. | L.L.* | |
| 4 | 8 | 8 | 8 | 10 | 4 ⁵ / ₈ | 8 | 5 ¹ / ₂ | 8 | 5 ¹ / ₂ | 8 | 4 ¹¹ / ₁₆ | 8 | 4 ⁵ / ₈ | |
| 6 | 8 | 8 | 8 | 10 | 4 ⁵ / ₈ | 8 | 5 ¹ / ₂ | 8 | 5 ¹ / ₂ | 8 | 4 ⁵ / ₈ | 8 | 4 ⁵ / ₈ | |
| 8 | 8 | 8 | 8 | 10 | 4 ⁵ / ₈ | 8 | 5 ¹ / ₂ | 8 | 5 ¹ / ₂ | 8 | 4 ¹ / ₄ | 8 | 4 ¹ / ₄ | |
| 10 | 8 | 8 | 8 | 10 | 4 ⁵ / ₈ | 8 | 5 ¹ / ₂ | 10 | 7 ¹ / ₂ | 8 | 4 ¹ / ₄ | 7 ¹ / ₄ | 3 ¹ / ₂ | |
| 12 | 8 | 8 | 8 | 10 | 4 ⁵ / ₈ | 8 | 5 ¹ / ₂ | 10 | 7 ¹ / ₂ | 8 | 4 ¹ / ₄ | 7 ¹ / ₄ | 3 ¹ / ₂ | |
| 14 | 8 ¹ / ₂ | 8 | 8 | 12 | 4 ¹ / ₂ | 8 | 4 ¹ / ₂ | 11 | 7 ¹ / ₂ | 8 | 2 ³ / ₄ | 9 ³ / ₄ | 4 ¹ / ₂ | |
| 16 | 8 ¹ / ₂ | 8 | 8 | 12 | 4 ¹ / ₂ | 8 | 4 ¹ / ₂ | 11 ¹ / ₂ | 8 | 8 | 2 ³ / ₄ | 9 ³ / ₄ | 4 ¹ / ₂ | |
| 18 | 8 ¹ / ₂ | 8 | 8 | 12 | 4 ¹ / ₂ | 8 | 4 ¹ / ₂ | 12 | 8 ¹ / ₂ | 8 | 1 ¹ / ₂ | 10 | 4 ¹ / ₂ | |
| 20 | 8 ¹ / ₂ | 8 | 8 | 12 | 4 ¹ / ₂ | 8 | 4 ¹ / ₂ | 12 | 8 ¹ / ₂ | 8 | 1 ¹ / ₂ | 10 | 4 ¹ / ₂ | |
| 24 | 9 ¹ / ₂ | 8 | 8 | 12 | 4 ¹ / ₂ | 8 | 4 ¹ / ₂ | 12 | 8 ¹ / ₂ | 8 | 1 ¹ / ₂ | 10 | 4 ¹ / ₂ | |
| 30 | 12 | 10 ¹ / ₂ | 8 | - | - | - | - | - | - | 8 | 1 ¹ / ₂ | 12 | 5 ¹ / ₂ | |
| 36 | 14 | 11 ¹ / ₂ | 8 | - | - | - | - | - | - | 8 | 1 ¹ / ₂ | 12 | 5 ¹ / ₂ | |
| 42 | 16 | 12 | 8 | - | - | - | - | - | - | 8 ¹ / ₂ | 1 | 14 | 6 ¹ / ₂ | |
| 48 | 16 | 12 | 8 | - | - | - | - | - | - | 9 | 1 | 15 | 7 | |
| 54 | 18 | 16 | 8 | - | - | - | - | - | - | 9 ¹ / ₂ | 1 | 16 | 7 ¹ / ₂ | |
| 60 | 18 | 16 | 8 | - | - | - | - | - | - | 9 ³ / ₄ | 1 | 16 | 7 ¹ / ₄ | |
| 64 | 18 | 16 | 8 | - | - | - | - | - | - | 10 | 1 | 16 | 7 | |

*Laying lengths are rounded to the nearest 1/4".
Thrust Collars may not be located in exact center of all minimum length pieces shown above.

Flanges and MJ bells of minimum-length pieces should normally be specified by the purchaser "lapped for studs" to enable assembly of joints flush with the wall face.

Maximum laying length of above wall pipe is 19'-6" (except 19'-0" for 64") except for MJ-T/C-PE or Fst-T/C-PE which may be furnished full 20' nominal length in all available sizes with the exception of 4" (4" maximum length is 18'-1 3/4"). 4"-16" Flange-Thrust Collar-Flange and Flange-Thrust Collar - PE pipe may also be furnished up to 20'-0" length. Contact AMERICAN if longer lengths required. All intermediate lengths can be furnished.

Wall pipe lengths shorter than those shown above can be furnished in some sizes by special fabrication. Contact AMERICAN for details.

Overall lengths are subject to manufacturing tolerances. If maximum overall length is critical, such as for installation of item inside steel forms, this must be specified by the purchaser on the order.

To determine weight of Thrust Collars Wall Pipe, use data in Table 7-1. Correctly installed flanged wall pipe will normally have the bolt holes straddling the horizontal and vertical centerlines. **Checking with a spirit level or plumb line prior to pouring the walls is recommended.**

Wall pipe with MJ threaded-on bells (MJ Fab), Flex-Ring, and Lok-Ring bells can also be furnished. Contact AMERICAN for dimensions not shown above.

Minimum-length pipes with plain ends (PE) in many cases do not allow enough room between PE and collar to assemble joints. Contact AMERICAN for PE joint assembly needs, normally requiring longer pipes.



AMERICAN Ductile Iron Specials
Wall Piping - Recommended Minimum Installation
Dimensions for Piping not Tapped for Studs

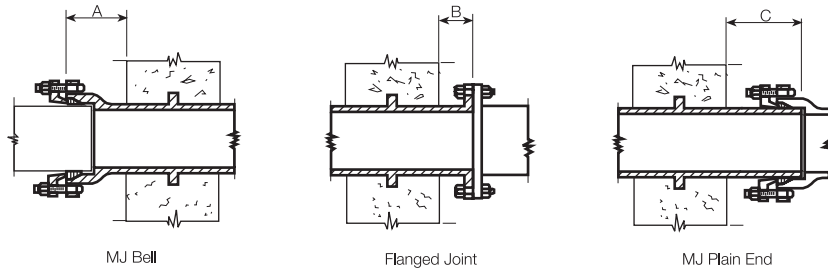

Table No. 7-4

| Size in. | A in. | B in. | C in. |
|----------|-------------------------------|--------------------------------|-------------------------------|
| 4 | 5 ³ / ₄ | 2 ¹ / ₄ | 6 |
| 6 | 5 ³ / ₄ | 2 ³ / ₄ | 6 |
| 8 | 6 ¹ / ₄ | 2 ³ / ₄ | 6 ¹ / ₂ |
| 10 | 6 ¹ / ₂ | 3 | 6 ¹ / ₂ |
| 12 | 6 ¹ / ₂ | 3 | 6 ¹ / ₂ |
| 14 | 7 | 3 ¹ / ₂ | 7 ³ / ₄ |
| 16 | 7 ¹ / ₄ | 3 ¹ / ₂ | 7 ³ / ₄ |
| 18 | 7 ¹ / ₂ | 3 ³ / ₄ | 7 ³ / ₄ |
| 20 | 7 ¹ / ₂ | 3 ³ / ₄ | 7 ³ / ₄ |
| 24 | 8 | 4 | 8 ¹ / ₄ |
| 30 | 9 ¹ / ₂ | 5 | 9 ³ / ₄ |
| 36 | 9 ³ / ₄ | 5 ¹ / ₄ | 9 ³ / ₄ |
| 42 | 10 | *5 ¹ / ₂ | 10 |
| 48 | 10 | *6 | 10 |
| 54 | — | *6 ¹ / ₄ | — |
| 60 | — | *6 ¹ / ₂ | — |
| 64 | — | *6 ³ / ₄ | — |

*The minimum dimension "B" for 42"-64" wall castings with threaded-on (AWWA C115) flange would be as follows: for 42", B = 6"; for 48", B = 6¹/₂"; for 54"-64", B = 7¹/₄".

Dimensions are based on standard mechanical joints per AWWA C111 and standard flanges per AWWA C110.

Wall piping with MJ bells or flanges having "A" and "B" dimensions shorter than those above, e.g. wall pipes with bell faces often placed "flush" with concrete form work, should be specified to be tapped for studs.

"A" and "C" dimensions for 14"-48" sizes apply to MJ castings only.



AMERICAN DUCTILE IRON PIPE

**AMERICAN Ductile Iron Specials
AMERICAN Fabricated Mechanical Joint Pipe
ANSI/AWWA C151/A21.51, C153/C21.53, and AMERICAN Standard**

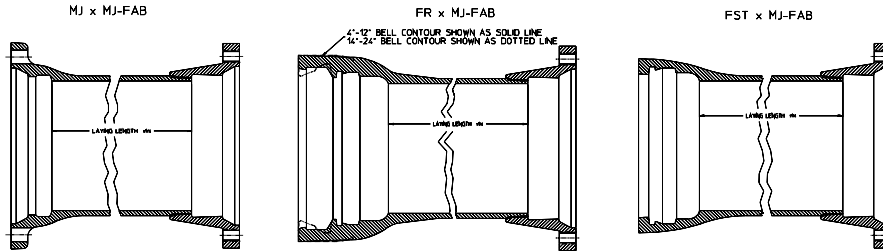

Table No. 7-5

| Size in. | Pressure Rating psi | Nominal Wall Thickness in. | Pipe O.D. in. | Fastite and MJ-Fab | | MJ and MJ-Fab | | Flex-Ring and MJ-Fab | | | | |
|----------|---------------------|----------------------------|---------------|---------------------------------|------------|------------------|---------------|----------------------|------------------|---------------------------------|------------|------------------|
| | | | | Laying Length | | Weight (Max.LL)* | Laying Length | | Weight (Max.LL)* | Laying Length | | Weight (Max.LL)* |
| | | | | Min. in. | Max ft.in. | Length lb | Min. in. | Max ft. in. | Length lb | Min. in. | Max ft.in. | Length lb |
| 4 | 350 | .32 | 4.80 | 2 ¹⁵ / ₁₆ | 19'6" | 325 | 4 | 19'6" | 295 | 2 ¹⁴ / ₁₆ | 19'6" | 295 |
| 6 | 350 | .34 | 6.90 | 3 ¹ / ₈ | 19'6" | 460 | 4 | 19'6" | 460 | 2 ¹⁴ / ₁₆ | 19'6" | 460 |
| 8 | 350 | .36 | 9.05 | 4 ³ / ₄ | 19'6" | 645 | 6 | 19'6" | 645 | 3 ³ / ₄ | 19'6" | 645 |
| 10 | 350 | .38 | 11.10 | 4 ³ / ₄ | 19'6" | 840 | 6 | 19'6" | 840 | 2 ³ / ₄ | 19'6" | 840 |
| 12 | 350 | .40 | 13.20 | 5 ³ / ₄ | 19'6" | 1055 | 6 | 19'6" | 1055 | 3 ³ / ₄ | 19'6" | 1055 |
| 14 | 350 | .42 | 15.30 | 4 ¹ / ₄ | 19'6" | 1315 | 7 | 19'6" | 1315 | 3 ¹ / ₈ | 19'6" | 1315 |
| 16 | 350 | .43 | 17.40 | 5 ¹ / ₄ | 19'6" | 1545 | 5 | 19'6" | 1545 | 5 ¹ / ₈ | 19'6" | 1545 |
| 18 | 350 | .44 | 19.50 | 5 | 19'6" | 1785 | 6 | 19'6" | 1785 | 4 ⁵ / ₁₆ | 19'6" | 1785 |
| 20 | 350 | .45 | 21.60 | 6 | 19'6" | 2030 | 6 | 19'6" | 2030 | 5 ⁵ / ₁₆ | 19'6" | 2030 |
| 24 | 350 | .47 | 25.80 | 7 | 19'6" | 2585 | 11 | 19'6" | 2470 | 6 ¹ / ₂ | 19'6" | 2585 |

Pipe is available with greater wall thicknesses than shown. Thicknesses above correspond to Special Thickness Class 53.
Any length between minimum and maximum shown can be furnished.
Tolerance on length is ± .25".
Socket depths for Threaded-on MJ Bells (MJ-Fab) are 2.88" for 4"-12" sizes and 4" for 14"-24" sizes.
* For 4"-24" sizes 19'-6".



AMERICAN Ductile Iron Specials

AMERICAN Flange Adaptor for AWWA C110/C115 Flange to ASME B16.1 Class 250# Flange AMERICAN Standard

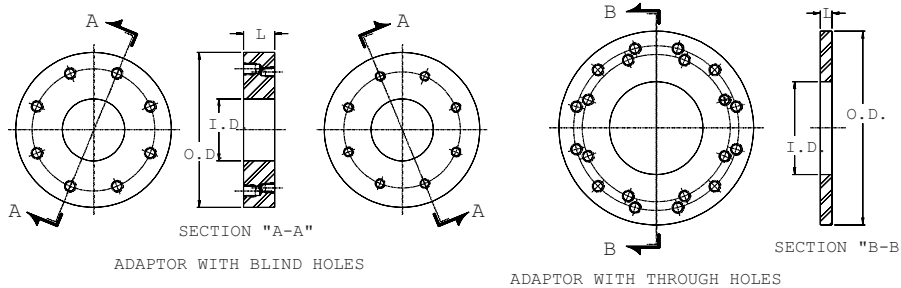

Table No. 7-6

| Size in. | Outside Diameter in. | Inside Diameter in. | Length "L" in. | Tap Depth | | Weight lb |
|----------|----------------------|---------------------|----------------|-----------------|----------------------------|-----------|
| | | | | C115 Flange in. | B16.1 Class 250 Flange in. | |
| 4 | 10.00 | 4.00 | 2 | 3/4 | 7/8 | 37 |
| 6 | 12.50 | 6.00 | 1 | Through | Through | 27 |
| 8 | 15.00 | 8.00 | 1 | Through | Through | 36 |
| 10 | 17.50 | 10.00 | 2 1/2 | 7/8 | 1 | 115 |
| 12 | 20.50 | 12.00 | 2 1/2 | 7/8 | 1 1/8 | 154 |
| 14 | 23.00 | 14.00 | 2 1/2 | 1 | 1 1/8 | 186 |
| 16 | 25.50 | 16.00 | 2 3/4 | 1 | 1 1/4 | 242 |
| 18 | 28.00 | 18.00 | 2 | Through | Through | 205 |
| 20 | 30.50 | 20.00 | 3 | 1 1/8 | 1 1/4 | 355 |
| 24 | 36.00 | 24.00 | 3 1/4 | 1 1/4 | 1 1/2 | 522 |
| 30 | 43.00 | 30.00 | 2 1/2 | Through | Through | 529 |
| 36 | 50.00 | 36.00 | 4 | 1 1/2 | 2 | 1141 |
| 42 | 57.00 | 42.00 | 4 | 1 1/2 | 2 | 1408 |
| 48 | 65.00 | 48.00 | 3 | Through | Through | 1285 |

Material is ASTM A36 steel.
 Holes are drilled and tapped to mate with AWWA C110/C115 flanges on one side and ANSI/ASME B16.1 Class 250 flanges on the opposite, or other side.
 Holes are equally spaced straddling centerline.
 12"-30" flange adaptors and 36"-48" flange adaptors are tapped at top dead center for 5/8" and 3/4" (5/8-11 UNC and 3/4-10 UNC threaded) lifting eyes, respectively.



**AMERICAN Ductile Iron Specials
Flange and Flare
90° Bends**

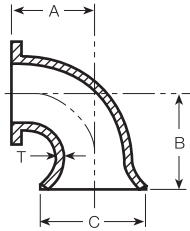

Short Radius

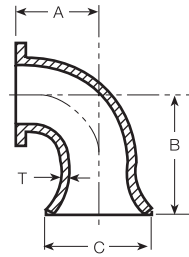

Long Radius

Table No. 7-7

| Size | T | C | Short Radius 90 Degree Flare Bends | | | Long Radius 90 Degree Flare Bends | | |
|------|------|-------|------------------------------------|-------|------|-----------------------------------|-------|------|
| | | | A | B | Wt. | A | B | Wt. |
| 4 | 0.52 | 9.00 | 6.50 | 12.00 | 45 | 9.00 | 14.50 | 50 |
| 6 | 0.55 | 11.00 | 8.00 | 12.00 | 75 | 11.50 | 15.50 | 90 |
| 8 | 0.60 | 13.50 | 9.00 | 14.00 | 120 | 14.00 | 19.00 | 155 |
| 10 | 0.68 | 16.00 | 11.00 | 17.00 | 195 | 16.50 | 22.50 | 250 |
| 12 | 0.75 | 19.00 | 12.00 | 18.00 | 275 | 19.00 | 25.00 | 375 |
| 14 | 0.66 | 21.00 | 14.00 | 21.50 | 310 | 21.50 | 29.00 | 400 |
| 16 | 0.70 | 23.50 | 15.00 | 23.00 | 395 | 24.00 | 32.00 | 530 |
| 18 | 0.75 | 25.00 | 16.50 | 25.00 | 495 | 26.50 | 35.00 | 675 |
| 20 | 0.80 | 27.50 | 18.00 | 27.00 | 630 | 29.00 | 38.00 | 865 |
| 24 | 0.89 | 32.00 | 22.00 | 32.50 | 995 | 34.00 | 44.50 | 1335 |
| 30 | 1.03 | 38.75 | 25.00 | 36.00 | 1970 | 41.50 | 48.50 | 2190 |
| 36 | 1.15 | 46.00 | 28.00 | 38.00 | 2730 | 49.00 | 56.00 | 3465 |
| 42 | 1.28 | 53.00 | 31.00 | 35.00 | 3200 | 56.50 | 63.50 | 5150 |
| 48 | 1.42 | 59.50 | 34.00 | 46.00 | 5235 | 64.00 | 71.00 | 6725 |

* 54" and 60" castings have wall thicknesses that are per AWWA C153. All other wall thicknesses are per C100.

** Contact AMERICAN for 64" Flare dimensions.

Since above fittings are not included in AWWA C110, A, B, and C dimensions above should be specified on engineering drawings.

Other joints can be furnished in lieu of flanges in some sizes.

See general notes on page 7-1.



AMERICAN Ductile Iron Specials Flare† Castings

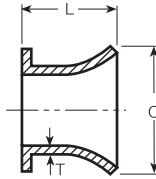

Flange and Flare

Table No. 7-8

| Size in. | Pressure Rating psi | Dimensions in Inches | | | | Weight in Lbs (Min. Length) |
|----------|---------------------|----------------------|-----------|-----------|-------|-----------------------------|
| | | T | L Minimum | L Maximum | C | Flg & Flare |
| 4 | 250 | .52 | 8 | 8 | 9.00 | 40 |
| 6 | 250 | .55 | 8 | 8 | 11.00 | 65 |
| 8 | 250 | .60 | 10 | 10 | 13.50 | 105 |
| 10 | 250 | .68 | 10 | 10 | 16.00 | 145 |
| 12 | 250 | .75 | 12 | 12 | 19.00 | 210 |
| 14 | 250 | .66 | 12 | 36 | 21.00 | 240 |
| 16 | 250 | .70 | 14 | 36 | 23.50 | 310 |
| 18 | 250 | .75 | 14 | 36 | 25.00 | 370 |
| 20 | 250 | .80 | 13 | 36 | 27.50 | 435 |
| 24 | 250 | .89 | 18 | 66 | 32.00 | 680 |
| 30 | 250 | 1.03 | 15 | 66 | 38.75 | 960 |
| 36 | 250 | 1.15 | 14 | 66 | 46.00 | 1265 |
| 42 | 250 | 1.28 | 12 | 72 | 53.00 | 1260 |
| 48 | 250 | 1.42 | 18 | 72 | 59.50 | 2375 |

† This fitting is sometimes referred to as "bell mouth."

* 54" and 60" castings have wall thicknesses that are per AWWA C153. All other wall thicknesses are per AWWA C100.

** Contact AMERICAN for 64" Flare dimensions.

Flare castings or fabrications can be furnished in a variety of lengths and with wall collars when specified. Flange or mechanical joint bell to be installed flush with the wall should be specified "tap for studs."

The addition of a wall collar to flare castings may affect the minimum length of the casting.

Other joints can be furnished in lieu of flanges or MJ bells in most sizes.

Since above fittings are not included in AWWA C110, L and C dimensions above should be specified on engineering drawings.

See general notes on page 7-1.



AMERICAN Ductile Iron Specials Outlet/Tapping Saddles

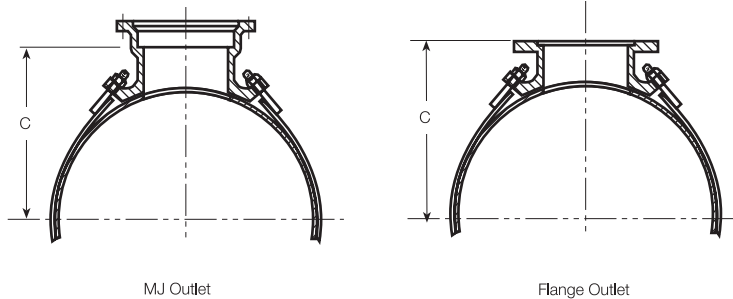

A saddle is furnished with AWWA C110 flange or mechanical joint outlet and can be installed on pipe with hole already machine cut, or torch cut at shop or job site. Saddle can thus be used on 12"–54" pipe for providing outlet as pipeline is being installed or in pipeline already installed. For a saddle in sizes 4"–12" with AWWA C110 flange connection on the branch, the flange is counterbored per MSS (Manufacturers' Standardization Society) SP-60 dimensions, making assembly possible with a tapping machine, tapping valve or a stan-

ard C110 flange. The inside diameter of the outlet is 1/4" greater than the nominal, enabling a full-size opening to be made in pipe wall. Counterbore dimensions are as tabulated below in Table No. 7-13.

| Size of Flange in. | Counterbore | |
|--------------------|-------------|--------------|
| | Depth in. | Diameter in. |
| 4 | .250 | 5.015 |
| 6 | .312 | 7.015 |
| 8 | .312 | 9.015 |
| 10 | .312 | 11.015 |
| 12 | .312 | 13.015 |

Table No. 7-9

| Size in. | O.D. of Parent Pipe in. | C in. | No. of Straps | Weight in Pounds | | |
|----------|-------------------------|-------|---------------|------------------|---------------|-------|
| | | | | Saddle Casting | Straps & Nuts | Total |
| 12 x 4 | 13.20 | 12.85 | 3 | 45 | 15 | 60 |
| 12 x 6 | 13.20 | 12.85 | 3 | 62 | 14 | 75 |
| 14 x 4 | 15.30 | 13.90 | 3 | 45 | 17 | 60 |
| 14 x 6 | 15.30 | 13.90 | 3 | 62 | 16 | 80 |
| 16 x 4 | 17.40 | 14.95 | 3 | 45 | 19 | 65 |
| 16 x 6 | 17.40 | 14.95 | 3 | 62 | 18 | 80 |
| 16 x 8 | 17.40 | 14.95 | 4 | 89 | 24 | 115 |
| 18 x 4 | 19.50 | 16.00 | 3 | 45 | 22 | 65 |
| 18 x 6 | 19.50 | 16.00 | 3 | 62 | 21 | 85 |
| 18 x 8 | 19.50 | 16.00 | 4 | 89 | 26 | 115 |
| 20 x 4 | 21.60 | 17.05 | 3 | 45 | 23 | 170 |
| 20 x 6 | 21.60 | 17.05 | 3 | 62 | 23 | 185 |
| 20 x 8 | 21.60 | 17.05 | 4 | 89 | 29 | 120 |
| 20 x 10 | 21.60 | 17.05 | 5 | 120 | 35 | 155 |
| 24 x 4 | 25.80 | 19.15 | 3 | 45 | 27 | 70 |
| 24 x 6 | 25.80 | 19.15 | 3 | 62 | 27 | 90 |
| 24 x 8 | 25.80 | 19.15 | 4 | 89 | 35 | 125 |
| 24 x 10 | 25.80 | 19.15 | 5 | 120 | 42 | 160 |
| 24 x 12 | 25.80 | 19.15 | 7 | 151 | 58 | 210 |

See notes at end of Table.



AMERICAN Ductile Iron Specials Outlet/Tapping Saddles

Table No. 7-9—Continued

| Size in. | O.D. of Parent Pipe in. | C in. | No. of Straps | Weight in Pounds | | |
|----------|-------------------------|-------|---------------|------------------|---------------|-------|
| | | | | Saddle Casting | Straps & Nuts | Total |
| 30 x 4 | 32.00 | 22.00 | 3 | 45 | 34 | 80 |
| 30 x 6 | 32.00 | 22.00 | 3 | 62 | 34 | 95 |
| 30 x 8 | 32.00 | 22.00 | 4 | 89 | 43 | 130 |
| 30 x 10 | 32.00 | 22.00 | 5 | 120 | 53 | 175 |
| 30 x 12 | 32.00 | 22.00 | 7 | 151 | 72 | 225 |
| 36 x 4 | 38.30 | 25.25 | 3 | 45 | 40 | 185 |
| 36 x 6 | 38.30 | 25.25 | 3 | 62 | 40 | 100 |
| 36 x 8 | 38.30 | 25.25 | 4 | 89 | 52 | 140 |
| 36 x 10 | 38.30 | 25.25 | 5 | 120 | 64 | 185 |
| 36 x 12 | 38.30 | 25.25 | 7 | 151 | 88 | 240 |
| 42 x 4 | 44.50 | 28.25 | 3 | 45 | 46 | 190 |
| 42 x 6 | 44.50 | 28.25 | 3 | 62 | 46 | 110 |
| 42 x 8 | 44.50 | 28.25 | 4 | 89 | 60 | 150 |
| 42 x 10 | 44.50 | 28.25 | 5 | 120 | 74 | 195 |
| 42 x 12 | 44.50 | 28.25 | 7 | 151 | 102 | 255 |
| 48 x 4 | 50.80 | 31.50 | 3 | 145 | 53 | 100 |
| 48 x 6 | 50.80 | 31.50 | 3 | 162 | 52 | 115 |
| 48 x 8 | 50.80 | 31.50 | 4 | 189 | 69 | 160 |
| 48 x 10 | 50.80 | 31.50 | 5 | 120 | 85 | 205 |
| 48 x 12 | 50.80 | 31.50 | 7 | 151 | 117 | 270 |
| 54 x 4 | 57.56* | 34.55 | 3 | 145 | 59 | 105 |
| 54 x 6 | 57.56* | 34.55 | 3 | 162 | 58 | 120 |
| 54 x 8 | 57.56* | 34.55 | 4 | 189 | 77 | 165 |
| 54 x 10 | 57.56* | 34.55 | 5 | 120 | 95 | 215 |
| 54 x 12 | 57.56* | 34.55 | 7 | 151 | 132 | 285 |

Weights are for saddle with MJ bell or AWWA C110 flange; weights do not include any MJ or flange joint materials. Saddles listed are rated 250 psi working pressure. Contact AMERICAN for higher pressure applications.
 Straps are alloy steel, 1/4" X 1 1/2" in cross section and are fabricated with 3/4" threaded ends. Sealing of saddle is provided by a positively confined "O-Ring" SBR rubber gasket, circular in cross section and made of molded rubber approximately 70 durometer hardness.
 Saddles to fit some other diameters can be furnished upon request. Order should specify diameter of parent pipe. Outlet can be furnished tapped for studs when specified.
 Maximum size outlet normally furnished for tapping 12"-14" pipe is 6"; for 16"-18" pipe is 8"; for 20" pipe is 10"; and for 24"-54" pipe is 12".
 On special order some outlets 14" -18" can be furnished for low pressure service on 30"-54" pipe.
 See general notes on page 7-1.
 *Prior to 1988, 54" AMERICAN pipe had an O.D. of 57.10". Installers should measure the O.D. of existing 54" pipe prior to ordering so that proper strap lengths can be furnished.

For recommended minimum installation distance (X) from face of Fastite bell to center of saddle, see Table No. 7-10.

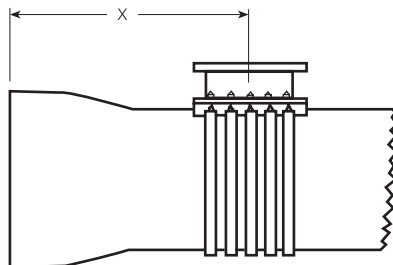

Table No. 7-10

| Size in. | "X" Min. |
|----------|----------|
| 12 x 6 | 12 |
| 14 x 6 | 14 |
| 16 x 8 | 14 |
| 18 x 8 | 16 |
| 20 x 10 | 16 |
| 24 x 12 | 18 |
| 30 x 12 | 18 |
| 36 x 12 | 18 |
| 42 x 12 | 20 |
| 48 x 12 | 20 |
| 54 x 12 | 20 |



AMERICAN Ductile Iron Specials Welded-on Outlets for Ductile Iron Pipe

AMERICAN regularly furnishes pipe with welded-on outlets for proven effectiveness and simplicity in layout and installation. Outlets can readily be located at variable positions along the pipeline, and rotation* of the pipe before it is assembled in the line can often position the outlet at any desired angle. This section provides detailed tabular data for 90° lateral and tangential welded-on outlets. Lateral outlets from 45°-90° in 15° increments from the parent pipe axis are also standardly available in some sizes with some additional outlet size restrictions. (Contact AMERICAN for details.)

JOINTS. The outlets are fabricated from centrifugally cast ductile iron pipe, manufactured and tested in accordance with ANSI/AWWA C151/A21.51. They may be furnished with any of AMERICAN's bell ends such as Fastite, MJ, Flex-Ring, or Lok-Ring. They can also be furnished with plain ends. The parent pipe can also be furnished with any type of joints.

THICKNESSES. Minimum nominal thicknesses for both parent and outlet pipe are shown in the following tables. The outlets are rated 200 to 250 PSI working pressure, depending on size, as noted in Table No. 7-11. Contact AMERICAN for higher pressure applications.

This is a shop fabricated product and is not intended for field fabrication. Welded-on outlets for ductile pipe are produced with qualified procedures and welders as per guidelines contained in ANSI/AWS D11.2, Guide for Welding Iron Castings. Joint materials are furnished with Fastite, MJ, Flex-Ring, and Lok-Ring bells. Parent and outlet pipe are normally furnished cement lined in accordance with ANSI/AWWA C104/A21.4. Contact AMERICAN if ends or linings other than cement linings are desired.

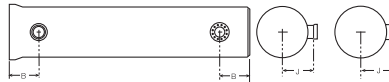

Table No. 7-11

| Parent Pipe Diameter in. | Maximum Outlet Diameter** in. | Minimum Nominal Thickness Parent Pipe in. | Standard "J" Dimension† Center-Socket Bell Outlet in. | Standard "J" Dimension† Center-Face Flange Outlet in. | Outlet Diameter** in. | Minimum Nominal Thickness-Outlet Pipe in. | Rated Water Working Pressure of Outlet (psi) | Min. Distance Outlet to Parent Pipe End in. †B†† |
|--------------------------|-------------------------------|---|---|---|-----------------------|---|--|--|
| — | — | — | — | — | 4 | 0.32 | 250 | 14-1/2 |
| 10 | 6 | 0.38 | 11 | 14-1/2 | 6 | 0.34 | 250 | 15-1/2 |
| 12 | 8 | 0.40 | 12 | 16 | 8 | 0.36 | 250 | 16-1/2 |
| 14 | 8 | 0.42 | 14 | 17 | 8 | 0.36 | 250 | 16-1/2 |
| 16 | 10 | 0.43 | 15 | 18 | 10 | 0.38 | 250 | 17-1/2 |
| 18 | 12 | 0.44 | 15-1/2 | 19-1/2 | 12 | 0.40 | 250 | 20 |
| 20 | 14 | 0.45 | 17 | 20-1/2 | 14 | 0.42 | 250 | 23 |
| 24 | 16 | 0.47 | 19 | 23 | 16 | 0.43 | 250 | 26 |
| — | — | — | — | — | 18 | 0.44 | 250 | 29 |
| 30 | 20 | 0.51 | 23 | 27 | 20 | 0.45 | 250 | 32-1/2 |
| 36 | 24 | 0.58 | 26 | 30-1/2 | 24 | 0.47 | 250 | 39 |
| 42 | 30 | 0.65 | 30 | 35 | 30 | 0.51 | 250 | 48 |
| 48 | 30 | 0.72 | 34 | 38-1/2 | 30 | 0.51 | 250 | 48 |
| 54 | 30 | 0.81 | 37 | 42 | 30 | 0.51 | 250 | 48 |
| 54 | 36 | 0.81 | 37 | 42 | 36 | 0.58 | 200 | 48 |
| 60 | 30 | 0.83 | 41 | 44 | 30 | 0.51 | 250 | 48 |
| 60 | 36 | 0.83 | 41 | 44 | 36 | 0.58 | 200 | 48 |
| 64 | 30 | 0.87 | 42 | 46 | 30 | 0.51 | 250 | 48 |
| 64 | 36 | 0.87 | 42 | 46 | 36 | 0.58 | 200 | 48 |

* Do not attempt to lift or rotate outlet pipes by attaching to or exerting force on the outlet or any branch piping attached thereto. Likewise, do not attach and suspend heavy piping items, etc., from outlet branch.

** The purpose of the 18" outlet diameter line is to provide this data when these standard outlets are applied on 30" and larger parent pipes only. Larger-diameter outlets may be available for some pressure and service applications. Contact AMERICAN for details.

† "J" dimensions are approximate and are the same for all different outlet sizes on a particular parent pipe size. Contact AMERICAN if different dimensions are required. Flanges used on outlets meet ASME B16.1 Class 125 requirements and may be welded on or threaded on.

†† Minimum "B" dimensions are dependent on outlet diameter and are not directly related to parent pipe diameter. For example, a "B" dimension for 6" outlets on all sizes of parent pipe (including 10") is 15 1/2", etc. Nominal thickness of 4"-54" diameter parent pipe and outlet pipe correspond to Special Class 53. Nominal thicknesses of

60" and 64" parent pipe correspond to Pressure Class 350 as shown in ANSI/AWWA C151/A21.51.

System design and installation should be such so as to avoid beam loads or impacts on the outlets. It is particularly important in underground service to use flexible joints (e.g., Flex-Ring or Fast-Grip) for outlet piping, to allow for at least some incidental movement between the parent and outlet piping. It should be noted that AWWA Manual M41 and the Appendix to ANSI/AWWA C115/A21.15 state that underground use of the flanged joint is generally not recommended because of the rigidity of the joint, and AMERICAN concurs with this guidance. Flexible outlet pipe joints should not be modified to make them rigid, nor should they be installed fully deflected.

This is a shop fabricated product and is not intended for field fabrication.

Contact AMERICAN for any applications of any flanged welded-on outlets involving connecting piping, such as pump suction and discharge headers, etc.



AMERICAN Ductile Iron Specials Tangential Welded-On Outlets for Ductile Iron Pipe

AMERICAN can furnish tangential welded-on outlets in certain diameters. Pipe with tangential outlets can often be positioned* with the outlets on bottom for blow offs or on top for air release. **Flanged and grooved joints are not available for tangential outlets.** Minimum pressure classes and location of outlets are the same as for regular welded-on outlets. This is a shop fabricated product and is not intended for field fabrication. Parent and outlet pipe are normally furnished cement lined in accordance with ANSI/AWWA C104/A21.4. Contact AMERICAN if ends or linings other than cement linings are desired.

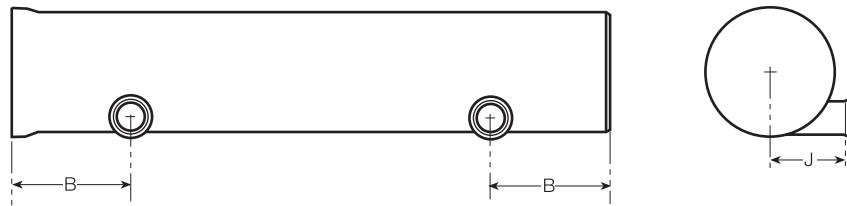

Table No. 7-12

| Parent Pipe Diameter in. | Outlet Diameter in. | Minimum Nominal Thickness* Parent/Outlet Pipe in. | Rated Water Working Pressure psi | Minimum "B" Location Outlet to Parent Pipe End in. | Standard "J" Dimension Center to Socket in. |
|--------------------------|---------------------|---|----------------------------------|--|---|
| 8 | 4 | 0.36/0.32 | 250 | 14-1/2 | 11-1/2 |
| 10 | 4 | 0.38/0.32 | 250 | 14-1/2 | 12-1/2 |
| 10 | 6 | 0.38/0.34 | 250 | 15-1/2 | 12-1/2 |
| 12 | 4 | 0.40/0.32 | 250 | 14-1/2 | 13-1/2 |
| 12 | 6 | 0.40/0.34 | 250 | 15-1/2 | 13-1/2 |
| 12 | 8 | 0.40/0.36 | 250 | 16-1/2 | 13-1/2 |
| 14 | 4 | 0.42/0.32 | 250 | 14-1/2 | 14 |
| 14 | 6 | 0.42/0.34 | 250 | 15-1/2 | 14-1/2 |
| 14 | 8 | 0.42/0.36 | 250 | 16-1/2 | 14-1/2 |
| 16 | 4 | 0.43/0.32 | 250 | 14-1/2 | 15 |
| 16 | 6 | 0.43/0.34 | 250 | 15-1/2 | 15-1/2 |
| 16 | 8 | 0.43/0.36 | 250 | 16-1/2 | 15-1/2 |
| 16 | 10 | 0.43/0.38 | 250 | 17-1/2 | 15-1/2 |
| 18 | 4 | 0.44/0.32 | 250 | 14-1/2 | 15-1/2 |
| 18 | 6 | 0.44/0.34 | 250 | 15-1/2 | 16-1/2 |
| 18 | 8 | 0.44/0.36 | 250 | 16-1/2 | 16-1/2 |
| 18 | 10 | 0.44/0.38 | 250 | 17-1/2 | 17 |
| 18 | 12 | 0.44/0.40 | 250 | 20 | 17 |
| 20 | 4 | 0.45/0.32 | 250 | 14-1/2 | 16 |
| 20 | 6 | 0.45/0.34 | 250 | 15-1/2 | 17 |
| 20 | 8 | 0.45/0.36 | 250 | 16-1/2 | 17-1/2 |
| 20 | 10 | 0.45/0.38 | 250 | 17-1/2 | 18 |
| 20 | 12 | 0.45/0.40 | 250 | 20 | 18 |
| 20 | 14 | 0.45/0.42 | 250 | 23 | 18 |

* Do not attempt to lift or rotate outlet pipes by attaching to or exerting force on the outlet or any branch piping attached thereto. Likewise, don't attach and suspend heavy piping items, etc., from outlet branch.



**AMERICAN Ductile Iron Specials
Tangential Welded-On Outlets
for Ductile Iron Pipe**

Table No. 7-12 - Continued

| Parent Pipe Diameter in. | Outlet Diameter in. | Minimum Nominal Thickness* Parent/Outlet Pipe in. | Rated Water Working Pressure psi | Minimum "B" Location Outlet to Parent Pipe End in. | Standard "J" Dimension Center to Socket in. |
|--------------------------|---------------------|---|----------------------------------|--|---|
| 24 | 4 | 0.47/0.32 | 250 | 14-1/2 | 17 |
| 24 | 6 | 0.47/0.34 | 250 | 15-1/2 | 18-1/2 |
| 24 | 8 | 0.47/0.36 | 250 | 16-1/2 | 19-1/2 |
| 24 | 10 | 0.47/0.38 | 250 | 17-1/2 | 20 |
| 24 | 12 | 0.47/0.40 | 250 | 20 | 20 |
| 24 | 14 | 0.47/0.42 | 250 | 23 | 20 |
| 24 | 16 | 0.47/0.43 | 250 | 26 | 20 |
| 30 | 4 | 0.51/0.32 | 250 | 14-1/2 | 18-1/2 |
| 30 | 6 | 0.51/0.34 | 250 | 15-1/2 | 20-1/2 |
| 30 | 8 | 0.51/0.36 | 250 | 16-1/2 | 21-1/2 |
| 30 | 10 | 0.51/0.38 | 250 | 17-1/2 | 22-1/2 |
| 30 | 12 | 0.51/0.40 | 250 | 20 | 23 |
| 30 | 14 | 0.51/0.42 | 250 | 23 | 23-1/2 |
| 30 | 16 | 0.51/0.43 | 250 | 26 | 23-1/2 |
| 30 | 18 | 0.51/0.44 | 250 | 29 | 23-1/2 |
| 30 | 20 | 0.51/0.45 | 250 | 32-1/2 | 23-1/2 |
| 36 | 4 | 0.58/0.32 | 250 | 14-1/2 | 20 |
| 36 | 6 | 0.58/0.34 | 250 | 15-1/2 | 22 |
| 36 | 8 | 0.58/0.36 | 250 | 16-1/2 | 24 |
| 36 | 10 | 0.58/0.38 | 250 | 17-1/2 | 25 |
| 36 | 12 | 0.58/0.40 | 250 | 20 | 25-1/2 |
| 36 | 14 | 0.58/0.42 | 250 | 23 | 26-1/2 |
| 36 | 16 | 0.58/0.43 | 250 | 26 | 26-1/2 |
| 36 | 18 | 0.58/0.44 | 250 | 29 | 26-1/2 |
| 36 | 20 | 0.58/0.45 | 250 | 32-1/2 | 26-1/2 |
| 36 | 24 | 0.58/0.47 | 250 | 39 | 26-1/2 |
| 42 | 4 | 0.65/0.32 | 250 | 14-1/2 | 21-1/2 |
| 42 | 6 | 0.65/0.34 | 250 | 15-1/2 | 23-1/2 |
| 42 | 8 | 0.65/0.36 | 250 | 16-1/2 | 25-1/2 |
| 42 | 10 | 0.65/0.38 | 250 | 17-1/2 | 27 |
| 42 | 12 | 0.65/0.40 | 250 | 20 | 28 |
| 42 | 14 | 0.65/0.42 | 250 | 23 | 28-1/2 |
| 42 | 16 | 0.65/0.43 | 250 | 26 | 29 |
| 42 | 18 | 0.65/0.44 | 250 | 29 | 29-1/2 |
| 42 | 20 | 0.65/0.45 | 250 | 32-1/2 | 29-1/2 |
| 42 | 24 | 0.65/0.47 | 250 | 39 | 30 |
| 42 | 30 | 0.65/0.51 | 250 | 48 | 30 |
| 48 | 4 | 0.72/0.32 | 250 | 14-1/2 | 22-1/2 |
| 48 | 6 | 0.72/0.34 | 250 | 15-1/2 | 25 |
| 48 | 8 | 0.72/0.36 | 250 | 16-1/2 | 27 |
| 48 | 10 | 0.72/0.38 | 250 | 17-1/2 | 28-1/2 |
| 48 | 12 | 0.72/0.40 | 250 | 20 | 30 |
| 48 | 14 | 0.72/0.42 | 250 | 23 | 31 |
| 48 | 16 | 0.72/0.43 | 250 | 26 | 31-1/2 |
| 48 | 18 | 0.72/0.44 | 250 | 29 | 32 |
| 48 | 20 | 0.72/0.45 | 250 | 32-1/2 | 32-1/2 |
| 48 | 24 | 0.72/0.47 | 250 | 39 | 33 |
| 48 | 30 | 0.72/0.51 | 250 | 48 | 34 |



AMERICAN Ductile Iron Specials
Tangential Welded-On Outlets
for Ductile Iron Pipe

Table No. 7-12 - Continued

| Parent Pipe Diameter in. | Outlet Diameter in. | Minimum Nominal Thickness* Parent/Outlet Pipe in. | Rated Water Working Pressure psi | Minimum "B" Location Outlet to Parent Pipe End in. | Standard "J" Dimension Center to Socket in. |
|--------------------------|---------------------|---|----------------------------------|--|---|
| 54 | 4 | 0.81/0.32 | 250 | 14-1/2 | 23-1/2 |
| 54 | 6 | 0.81/0.34 | 250 | 15-1/2 | 26 |
| 54 | 8 | 0.81/0.36 | 250 | 16-1/2 | 28-1/2 |
| 54 | 10 | 0.81/0.38 | 250 | 17-1/2 | 30 |
| 54 | 12 | 0.81/0.40 | 250 | 20 | 31-1/2 |
| 54 | 14 | 0.81/0.42 | 250 | 23 | 33 |
| 54 | 16 | 0.81/0.43 | 250 | 26 | 34 |
| 54 | 18 | 0.81/0.44 | 250 | 29 | 34-1/2 |
| 54 | 20 | 0.81/0.45 | 250 | 32-1/2 | 35-1/2 |
| 54 | 24 | 0.81/0.47 | 250 | 39 | 36 |
| 54 | 30 | 0.81/0.51 | 250 | 48 | 37-1/2 |
| 54 | 36 | 0.81/0.58 | 200 | 48 | 37-1/2 |
| 60 | 4 | 0.83/0.32 | 250 | 14-1/2 | 25 |
| 60 | 6 | 0.83/0.34 | 250 | 15-1/2 | 28 |
| 60 | 8 | 0.83/0.36 | 250 | 16-1/2 | 30-1/2 |
| 60 | 10 | 0.83/0.38 | 250 | 17-1/2 | 32 |
| 60 | 12 | 0.83/0.40 | 250 | 20 | 34 |
| 60 | 14 | 0.83/0.42 | 250 | 23 | 35 |
| 60 | 16 | 0.83/0.43 | 250 | 26 | 36 |
| 60 | 18 | 0.83/0.44 | 250 | 29 | 37 |
| 60 | 20 | 0.83/0.45 | 250 | 32-1/2 | 38 |
| 60 | 24 | 0.83/0.47 | 250 | 39 | 39 |
| 60 | 30 | 0.83/0.51 | 250 | 48 | 39-1/2 |
| 60 | 36 | 0.83/0.58 | 200 | 48 | 39-1/2 |
| 64 | 4 | 0.87/0.32 | 250 | 14-1/2 | 25-1/2 |
| 64 | 6 | 0.87/0.34 | 250 | 15-1/2 | 28-1/2 |
| 64 | 8 | 0.87/0.36 | 250 | 16-1/2 | 31 |
| 64 | 10 | 0.87/0.38 | 250 | 17-1/2 | 33 |
| 64 | 12 | 0.87/0.40 | 250 | 20 | 35 |
| 64 | 14 | 0.87/0.42 | 250 | 23 | 36-1/2 |
| 64 | 16 | 0.87/0.43 | 250 | 26 | 37-1/2 |
| 64 | 18 | 0.87/0.44 | 250 | 29 | 38-1/2 |
| 64 | 20 | 0.87/0.45 | 250 | 32-1/2 | 39-1/2 |
| 64 | 24 | 0.87/0.47 | 250 | 39 | 40-1/2 |
| 64 | 30 | 0.87/0.51 | 250 | 48 | 41-1/2 |
| 64 | 36 | 0.87/0.58 | 200 | 48 | 41-1/2 |

* Nominal thickness of 4"-54" diameter parent pipe correspond to Special Class 53. Nominal thickness of 60" and 64" parent pipe correspond to Pressure Class 350.



AMERICAN Ductile Iron Specials Ductile Iron Trenchless Pipe

By its nature, ductile iron pipe possesses tremendous columnar and tensile strength, which makes it a superior material for trenchless applications. AMERICAN offers two joints designed for use in direct jacking, trenchless pipeline replacement, pipe bursting, and microtunneling installation. Fastite joint push-bar pipe allows the Fastite Joint to be used in trenchless applications using direct jacking or pushing. Flex-Ring® joint pipe with its positive, flexible joint restraint has been used extensively in pipe pulling applications using horizontal directional drilling and some pipe bursting installation methods. With spigots ahead, the low profile Flex-Ring® assembles quickly and offers a smooth transition during pipe pull-back. AMERICAN offers a Flex-Ring® pulling bell assembly specifically designed for this installation method.



Pulling Bell

Push-Bar pipe employs an economical adaptation of the premier AMERICAN Fastite joint to transfer jacking loads from the pipe barrel directly to the face of the bell. It consists of a high-strength, alloy steel ring, the "push-bar," shop welded to the standard Fastite pipe spigot. This ring is made of the same material that has been used successfully in AMERICAN's Lok-Ring and other restrained joints for more than 40 years. A cushioning compression ring, made of compressible wood products, fits between the push-bar and the pipe bell for added assurance of load distribution. The pipe comes in standard 20' or less standard nominal laying lengths and carries the standard Fastite joint pressure ratings. During installation, Fastite joint push-bar pipe is jacked or pushed with the spigots ahead. This allows for any debris remaining from the pipe bursting or pipe jacking operation to flow smoothly over the bell of the Fastite joint.

Flex-Ring joint pipe and allowable pulling loads are covered in Tables 7-13 and 7-1. See above picture of Flex-Ring pulling bell assembly at left.

Cement-mortar lining per ANSI/AWWA C104/A21.4 and asphalt exterior coating per ANSI/AWWA C151/A21.51 are standard for Flex-Ring and push-bar pipe. Other linings and coatings are available for specific service conditions.



AMERICAN Ductile Iron Flex-Ring® Joint Pipe Standard Dimensions and Pressure Ratings

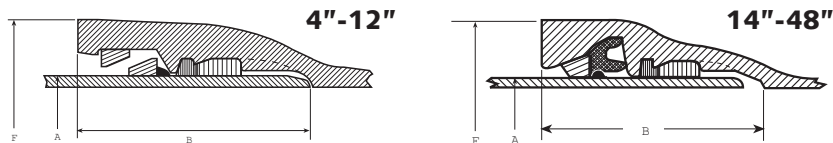

Table No. 7-13

4"-12"

| Size in. | Working Pressure* psi | Nominal Laying Length** ft. | A O.D. in. | B Socket Depth in. | F Bell O.D.† in. | Allowable Pulling Load lb.†† | Allowable Deflection degree | Offset per 20' Length in. | Radius of Curve^ ft. | Empty Pipe Buoyancy in Water (lb/ft)^^^ |
|----------|-----------------------|-----------------------------|------------|--------------------|------------------|------------------------------|-----------------------------|---------------------------|----------------------|---|
| 4 | 350 | 20 | 4.80 | 5.62 | 7.06 | 10,000 | 5 | 21 | 230 | -5 |
| 6 | 350 | 20 | 6.90 | 5.62 | 9.19 | 20,000 | 5 | 21 | 230 | -2 |
| 8 | 350 | 20 | 9.05 | 5.74 | 11.33 | 30,000 | 5 | 21 | 230 | 3 |
| 10 | 350 | 20 | 11.10 | 6.72 | 13.56 | 45,000 | 5 | 21 | 230 | 11 |
| 12 | 350 | 20 | 13.20 | 6.72 | 15.74 | 60,000 | 5 | 21 | 230 | 19 |

* Working pressure is the maximum pressure rating of the joint and is based on its capability to resist thrust due to internal pressure. If higher working pressure is required, contact AMERICAN.

** Laying length is nominal 20'. Where exact lengths are required, contact AMERICAN. Minimum laying lengths for Flex-Ring & Flex-Ring end pipe is 1'-0" and for Flex-Ring End & Flex-Ring end pipe is 2'-0".

† Dimensions subject to change at our option. Contact AMERICAN if smaller or exact dimensions are required.

†† Intended for horizontal directional drilling (HDD) applications. Flex-Ring pipe may be available for greater pulling loads than indicated in the tabulated values. Contact AMERICAN when higher pulling loads are required.

^ Approximate radius of curve produced by a succession of 20' lengths of pipe fully deflected.

^^ Based on weight of empty (full of air) Pressure Class 350 Flex-Ring pipe with standard cement lining immersed in water. Positive numbers indicate such pipe will float.

Table No. 7-14

14"-48"

| Size in. | Working Pressure* psi | Nominal Laying Length** ft. | A O.D. in. | B Socket Depth in. | F Bell O.D.† in. | Allowable Pulling Load lb.†† | Allowable Deflection degree | Offset per 20' Length in. | Radius of Curve^ ft. | Empty Pipe Buoyancy in Water (lb/ft)^^^ |
|----------|-----------------------|-----------------------------|------------|--------------------|------------------|------------------------------|-----------------------------|---------------------------|----------------------|---|
| 14 | 350 | 20 | 15.30 | 7.38 | 19.31 | 75,000 | 4 | 17 | 285 | 27 |
| 16 | 350 | 20 | 17.40 | 7.38 | 21.08 | 95,000 | 3 3/4 | 16 | 305 | 38 |
| 18 | 350 | 20 | 19.50 | 8.20 | 23.70 | 120,000 | 3 3/4 | 16 | 305 | 52 |
| 20 | 350 | 20 | 21.60 | 8.20 | 25.37 | 150,000 | 3 1/2 | 15 | 327 | 69 |
| 24 | 350 | 20 | 25.80 | 8.96 | 29.88 | 210,000 | 3 | 12 | 380 | 104 |
| 30 | 250 | 20 | 32.00 | 9.63 | 36.34 | 220,000 | 2 1/2 | 10 | 458 | 175 |
| 36 | 250 | 20 | 38.30 | 9.63 | 43.10 | 310,000 | 2 | 8 | 570 | 266 |
| 42 | 250 | 20 | 44.50 | 10.84 | 49.92 | 390,000 | 2 | 8 | 570 | 359 |
| 48 | 250 | 20 | 50.80 | 12.37 | 56.36 | 500,000 | 2 | 8 | 570 | 484 |
| 54 | 250 | 20 | 57.56 | 12.74 | 63.90 | 650,000 | 1 1/2 | 8 | 570 | 632 |

* Working pressure is the maximum pressure rating of the joint and is based on its capability to resist thrust due to internal pressure. If higher working pressure is required, contact AMERICAN. Pressure rating of the joint is limited by the pressure rating of the parent pipe.

** Laying length is nominal 20'. Where exact lengths are required, contact AMERICAN.

† Dimensions subject to change at our option. Contact AMERICAN if smaller or exact dimensions are required.

†† Intended for horizontal directional drilling (HDD) applications. The tabulated values are based on Pressure Class pipe thickness of the "Working Pressure" shown. Contact AMERICAN when it may be desirable to use lesser pressure class pipe or when higher pulling loads are required. Flex-Ring pipe may be available for greater pulling loads than indicated in the tabulated values.

^ Approximate radius of curve produced by a succession of 20' lengths of pipe fully deflected.

^^ Based on weight of empty (full of air) Pressure Class 350 Flex-Ring pipe with standard cement lining immersed in water. Positive numbers indicate such pipe will float.

Minimum Laying Lengths

| Size in. | Flex-Ring & Flex-Ring End | Flex-Ring End & Flex-Ring End |
|----------|---------------------------|-------------------------------|
| 14 | 1'-6" | 2'-0" |
| 16 | 1'-6" | 2'-0" |
| 18 | 1'-6" | 2'-0" |
| 20 | 1'-6" | 2'-0" |
| 24 | 2'-0" | 2'-6" |
| 30 | 2'-0" | 2'-6" |
| 36 | 2'-0" | 2'-6" |
| 42 | 2'-0" | 3'-0" |
| 48 | 2'-6" | 3'-0" |
| 54 | 3'-0" | 3'-6" |



AMERICAN DUCTILE IRON PIPE

AMERICAN Ductile Iron Specials
AMERICAN Fastite Joint Push-Bar Pipe

ANSI/AWWA C151/A21.51 and AMERICAN Standard

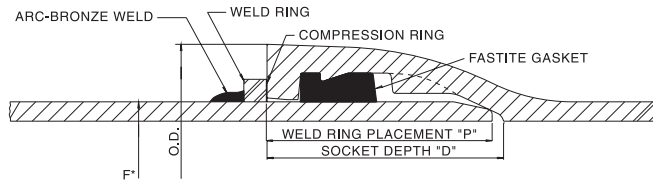
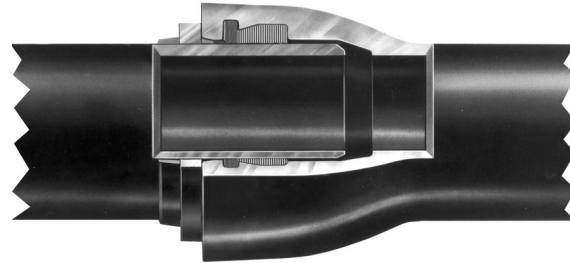

Table No. 7-15

| Pipe Size in. | Standard Nominal Laying Length | Pipe O.D. in. | F* Bell O.D. in. | Weld Ring Size | P in. | D in. | Rated Push** (lb. x 1000) |
|---------------|--------------------------------|---------------|------------------|---------------------|-------|-------|---------------------------|
| 4 | 20 | 4.80 | 6.40 | 1/2" sq. | 3.13 | 3.31 | 54 |
| 6 | 20 | 6.90 | 8.60 | 1/2" sq. | 3.25 | 3.38 | 78 |
| 8 | 20 | 9.05 | 10.96 | 1/2" sq. | 3.63 | 3.75 | 102 |
| 10 | 20 | 11.10 | 13.12 | 1/2" sq. | 3.63 | 3.75 | 125 |
| 12 | 20 | 13.20 | 15.22 | 1/2" sq. | 3.63 | 3.75 | 150 |
| 14 | 20 | 15.30 | 17.61 | 1/2" sq. | 5.00 | 5.23 | 260 |
| 16 | 20 | 17.40 | 19.74 | 1/2" sq. | 5.00 | 5.23 | 296 |
| 18 | 20 | 19.50 | 22.16 | 1/2" sq. | 5.38 | 5.50 | 312 |
| 20 | 20 | 21.60 | 24.28 | 1/2" sq. | 5.38 | 5.50 | 345 |
| 24 | 20 | 25.80 | 28.50 | 1/2" sq. | 5.38 | 5.50 | 413 |
| 30 | 20 | 32.00 | 34.95 | 5/8" sq. | 6.38 | 6.50 | 545 |
| 36 | 20 | 38.30 | 41.37 | 5/8" sq. | 6.38 | 6.50 | 650 |
| 42 | 20 | 44.50 | 48.27 | 3/4" x 1 1/4" rect. | 7.38 | 7.50 | 818 |
| 48 | 20 | 50.80 | 54.71 | 3/4" x 1 1/4" rect. | 7.88 | 8.00 | 934 |
| 54 | 20 | 57.56 | 61.65 | 3/4" x 1 1/4" rect. | 8.38 | 8.50 | 1,058 |
| 60 | 20 | 61.61 | 65.80 | 3/4" x 1 1/4" rect. | 8.62 | 8.75 | 1,132 |
| 64 | 20 | 65.67 | 70.04 | 3/4" x 1 1/4" rect. | 8.88 | 9.00 | 1,206 |

* Dimensions subject to change at our option. Contact AMERICAN if exact dimensions required.

**Allowable axial compression loads for the Fastite push-bar joint in straight alignment. Contact AMERICAN if higher pushing loads are required.

See Section 3 for pipe classes and pressure ratings



Long-Span and Piping Supports

The beam strength of ductile iron pipe, along with the capability of certain AMERICAN joints, allows the installation of clear spans of up to 48' or more in sizes 6" - 64". This was made possible due to the advent of AMERICAN's unique Toruseal® gaskets** in the 1970s.

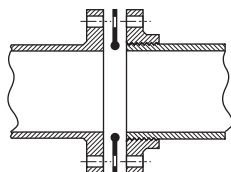

Shown below are sketches of three cases of long-span or pipe-on-supports situations. Case #1 shows traditional pipe-on-supports installations where one support is provided for each length of pipe. Cases #2 and #3 show long-span pipe assemblies that use AMERICAN's Toruseal® gaskets. Other pipe assemblies using other AMERICAN joints may be possible depending upon circumstances. Notes under each case apply to that case. General notes are shown at the end.

*Contact AMERICAN on long-span requirements involving 4" pipe.

**See Sections 6 and 8 for details on Toruseal Gaskets.

Case #1

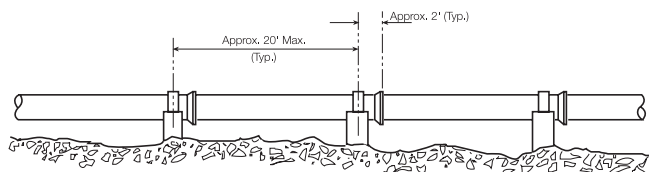

Case #1 uses 20' or less lengths of Fastite, MJ, or other push-on restrained pipe. (See page 7-29 General Note 3.) This length is normally subject to normal manufacturing and trim (cut pipe) variations, with some pipe allowed up to two feet shorter than full length. Where exact length pipe is required, say to fit existing pier spacings, etc., contact AMERICAN.

Minimum pressure classes of all sizes of ductile iron pipe are more than adequate to support the weight of the pipe and the water it contains in Case #1 installations when analyzed and installed in accordance with the suggestions in the Ductile Iron Pipe Research Association's procedure for "Design for Ductile Iron Pipe on Supports." This procedure is available from AMERICAN.



Long-Span and Piping Supports

Case #2

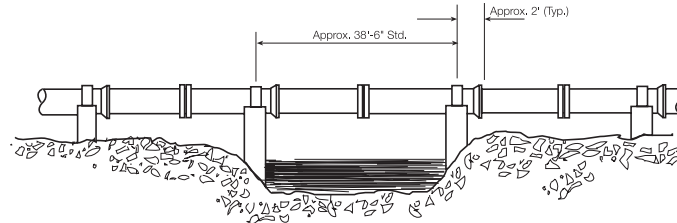

Case #2 uses 19'-3" lengths of flange plain end and flange bell (Fastite, MJ, or other push-on restrained) pipe. (MJ pipe is not available over 12" in diameter.) Since Case #2 uses flanged pipe joints, minimum nominal thicknesses shown in AWWA C115 are required.

Case #3

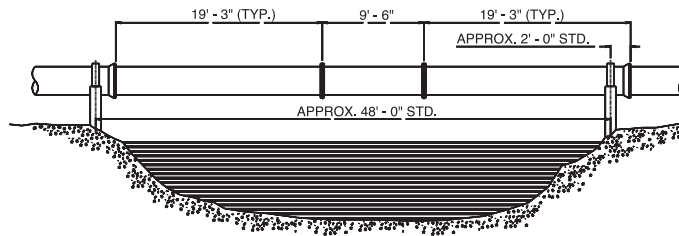

Case #3 uses 19'-3" lengths of flange bell and flange plain end pipe with a 9'-6" flange-flange pipe in the center. This can result in more mid-span deflection than Case #2 and, therefore, it is normally used only in 18" and larger sizes.

Since Case #3 uses flanged pipe joints, minimum nominal thicknesses for fabricated flanged pipe shown in AWWA C115 are required.



LONG SPAN AND PIPING SUPPORTS

GENERAL NOTES

1. Principles presented in the DIPRA publication "Design of Ductile Iron Pipe on Supports" can be used to calculate the maximum localized stress due to support reaction and to approximate the maximum beam-bending stress near mid-span of these systems. This publication can be obtained from AMERICAN.

2. Small-diameter pipe systems with very long unsupported pipe spans can exhibit visible mid-span deflection, or "sag." While this deflection results in no structural problems, the designer may consider means to reduce or eliminate midspan deflection if aesthetic or other concerns are anticipated in the application.

3. Push-on or push-on restrained joint pipe is normally a better choice than mechanical joint pipe due to more tolerance for thermal expansion and contraction, movement effects, and other aspects. Mechanical joints are not available from AMERICAN for ductile iron pipe over 12".

4. Where pipeline bends adjacent to crossings are externally restrained for restraint of axial pressure thrust, or where there are no bends adjacent to crossings to result in such thrusts, it is common to install push-on or mechanical pipe joints with a slight axial "gap" (1/8"-1/4") between the spigot and the back of the socket, and with the pipe sections firmly strapped to shaped pier supports located immediately behind the pipe bells as indicated. This is appropriate for normal anticipated thermal expansion and contraction of individual pipe sections and is easy to accomplish in the field by assembling the joints to metal contact condition and then "backing them out" slightly. Slight rebating deflection (or "wiggling") of the joint can produce the desired results, with field marking of the relative position of the spigot to the bell face to gauge results.

5. It is generally recommended that effective lateral restraint (means of assuring lateral stability of joints) be provided for the joints of all pipe-on-support installations, particularly in pressure pipelines and in other cases where lateral or columnar forces may exist to deflect joints or to dislodge the pipeline from the supports. Unstabilized, single rod or other hangers may not be desirable for pressure or other pipelines.

6. Contact AMERICAN where other design factors are a consideration. Systems where crossing pipe is subject to axial thrust forces or movements from bends, etc., long bridge crossings, large or concentrated thermal expansion-contraction effects, pipe-on-rollers, etc., are applications that may involve special design concerns.

7. The piping layouts as per Cases 2-3 consider the possibility of projects with sizable numbers of exact length repetitive pipe "spans." Where lesser numbers of spans are involved on candidate projects, it may be practical and more economical to provide slightly longer "standard spans," say by furnishing longer laying length intermediate flanged pipe (see Sec. 8) in lieu of the 19'-3" lengths depicted in these cases, etc. Contact AMERICAN if this is necessary or desirable.

Section 8

AMERICAN Flanged Pipe





AMERICAN Flanged Pipe

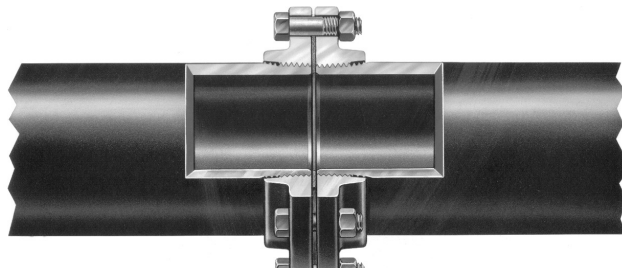

The principal standards covering Flanged Pipe are ANSI/AWWA C115/A21.15 and ANSI/AWWA C110/A21.10. These and other standards are referenced throughout this Section either by the full ANSI/AWWA designation or by only the AWWA numbering, such as AWWA C115.

AMERICAN produces 4" - 64" ductile iron flanged pipe with threaded flanges for water or other liquids in accordance with AWWA C115. Maximum length of flanged pipe is 17'6", 19'0", 19'6", or 20'0", depending on size; any length less than maximum can be furnished down to minimum practical lengths, varying also with pipe size. Flanges generally are threaded on all flanged pipe, except for short lengths of pipe which may be produced statically with integrally cast flanges as shown in Table Nos. 8-9 and 8-10; static castings are manufactured in accordance with applicable requirements of AWWA C110.

Flanged pipe is generally specified for aboveground service for air, water, sewage, oil and other liquids where rigid, restrained joints are needed. It is widely used in industrial piping systems, water treatment plants and sewage treatment plants, and for other interior piping.

Long runs of flanged pipe should normally include design provisions for thermal expansion and contraction, such as flexible joints or couplings at strategic intervals.

Pipe may be furnished with one end flanged and the other end with Fastite bell, mechanical joint bell, restrained joint bell, plain end, grooved or shouldered end, or with other type end as may be required.

The underground use of the flanged joint is generally not recommended due to

the rigidity of the joint as noted in appendices of appropriate ANSI/AWWA standards.

Flanged pipe is rated for a maximum working pressure of at least 250 psi as specified in the tables in this Section. The AWWA C110 and C115 flanges (as well as the flanges faced and drilled per ANSI B16.1 Class 250) are also rated for maximum water working pressure of at least 250 psi. The flanges faced and drilled per ANSI B16.1 Class 250 are special; they do not match other flanges and are infrequently furnished. AMERICAN furnishes these only as a transition from equipment with these flanges to regular AWWA C110 or C115 flanges. These flanges faced and drilled per ANSI B16.1 Class 250 are shown in Table Nos. 8-11, 8-12 and 8-13 which are shaded to signify their special nature. AMERICAN flanged pipe in sizes 24" and smaller is rated for 350 psi working pressure only when AMERICAN Toruseal® gaskets are used. In some cases other sizes of flanged pipe have been supplied for working pressures greater than 250 psi, again when joined with AMERICAN Toruseal® gaskets. Check AMERICAN for details.

Coatings and Linings

The standard outside coating for flanged pipe is a one-mil-thick asphaltic paint, but other outside coatings per Section 11 can be furnished when specified.



AMERICAN DUCTILE IRON PIPE

While other linings are available as described in Section 11, cement lining, per AWWA C104, is usually furnished in flanged piping. Where AMERICAN is given the option, flanged pipe is normally furnished cement lined depending on availability.

A rust preventive coating is applied to the machined faces of the flanges; this coating may be removed prior to installation.

Pipe Barrel and Flanges

Ductile iron pipe barrels conform to the requirements of AWWA C151. All flanges furnished by AMERICAN for threading on ductile iron pipe are ductile iron in accordance with AWWA C115. (AMERICAN recommends only ductile iron flanges for strength and safety, though AWWA C115 currently allows both ductile iron and gray iron flanges.)

Flanges conform to the chemical and physical properties specified for ductile iron fittings in AWWA C110.

The minus thickness tolerances of the pipe barrels are shown below.

Table No. 8-1

| Pipe Size in. | Minus Tolerance AWWA C151 in. |
|------------------|-------------------------------------|
| 4"–8" | 0.05 |
| 10"–12" | 0.06 |
| 14"–42" | 0.07 |
| 48" | 0.08 |
| 54"–64" | 0.09 |

Pipe barrels and flanges have tapered pipe threads (NPT) in accordance with ANSI B2.1 adapted to the ductile iron pipe outside diameters. The flange is threaded onto the pipe and machine tightened until the pipe end projects beyond the face of the flange; it is then machined to give a flush finish of the pipe end and flange and to ensure that the flange face is perpendicular to the axis of the pipe. The flange is designed so that a shroud substantially covers the working threads of the pipe for thread protection. Prior to assembly of the flange on the pipe, a commercial-grade thread compound is applied to the threads to ensure leak-free fabrication.

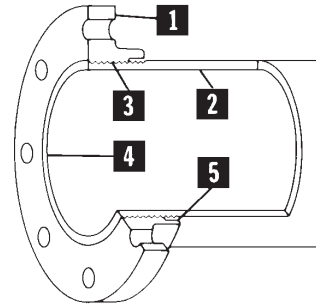

1—Ductile iron flange; 2—Ductile iron pipe barrel; 3—AMERICAN Standard Pipe Threads, ANSI B2.1, adapted to ductile iron outside diameters; 4—Pipe end and barrel machined simultaneously to a flush finish; and 5—Shroud.

AMERICAN Flanged Pipe is shop fabricated in accordance with AWWA C115 and threading at the job site is not recommended. Flanges furnished on pipe are not interchangeable in the field and generally cannot be removed after fabrication without damaging the pipe and/or flange threads. If installation conditions require assembly of the flange on the job, the flange may be factory assembled to a "hand-tight" condition. This permits removal and re-assembly at the job site at which time suitable thread compound must be used. "Hand-tight" flanges should be limited to 16" and smaller sizes because of the difficulty in tightening larger flanges at the job site.

JOINT MATERIALS

Joint materials are normally furnished for all mechanical joint bell openings on pipe or fittings. With the exception of AMERICAN Toruseal® gaskets specifically recommended for superior performance, flanged joint materials are not normally furnished by AMERICAN, although they are generally available from stock. See Table Nos. 8-2 in this section and 8-3 in Details and Accessories.

Since flanged bolts are not generally furnished by AMERICAN, the following is given for information only.



Bolts and Nuts

Size, length and number of bolts and nuts are shown in Table Nos. 8-3 (Details and Accessories-AWWA C110 or C115 flange) and 8-11 (Details and Accessories-flange faced and drilled per ANSI B16.1 Class 250). Bolts are specified in ANSI B18.2.1 and nuts are specified in ANSI B18.2.2. Bolts and nuts of low-carbon steel conforming to ASTM A307 are specified in the Appendix of AWWA C110 and C115 for flanged pipe when rubber gaskets are used. Nuts of regular or heavy hex design are used according to customer specifications. Also, per the Appendix of AWWA C110 and C115, high-strength bolts should not be used when a gray iron flange is involved in the connection.

lengths of pipe) or with any underground flanges* that could be subjected to undesirable beam loading. Toruseal® gaskets are normally furnished of high-quality black, molded SBR rubber with required properties per ANSI/AWWA C111/A21.11. Standard Toruseal® SBR rubber gaskets are ANSI/NSF Standard 61 certified for contact with potable water. Other type rubber is available on special order. AMERICAN Toruseal® gaskets meet the description of “specially designed gaskets” shown in the appendices of AWWA C110, C111, and C115, and “special gaskets” shown in the body of AWWA C111.

*As noted in the appendices of appropriate ANSI/AWWA standards, the use of flanged joints underground is generally not recommended because of the rigidity of the joint.



NSF 61 certified Toruseal® Gasket

AMERICAN Toruseal® Flange Gasket

The AMERICAN Toruseal® flange gasket is available for improved joint performance. It is vastly superior to conventional full-face or ring gaskets. Although recommended for all normal water and sewer service, it especially must be used in demanding services such as very large diameter flanged piping, specially designed long-span installations (i.e. spans involving 2 or 3

Gaskets

AMERICAN Toruseal® gaskets are recommended for AWWA standard flanged joints in normal water and sewage service. The ANSI B16.21 standard specifies the inside of 3”-12” non-metallic full-face and ring gaskets to be greater (the same as standard steel pipe outside diameters) than nominal. Any flat gaskets used for ductile iron flanged pipe must have “nominal” inside diameters as shown in the appendix of ANSI/AWWA C115/A21.15, not the larger inside diameters per ANSI B16.21. **The larger I.D. gaskets per ANSI B16.21 are not recommended by AMERICAN.**

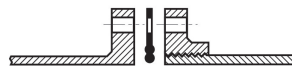

AMERICAN Toruseal® Flange Gasket

Full-Face — Nominal 1/8” Thickness — Dual Raised Torus Bulbs

Table No. 8-2

| Pipe Size in. | Pressure Rating* psi | Gasket Weight lbs | Approx. Bolt Torque** ft.-lbs | Pipe Size in. | Pressure Rating* psi | Gasket Weight lbs | Approx. Bolt Torque** ft.-lbs |
|---------------|----------------------|-------------------|-------------------------------|---------------|----------------------|-------------------|-------------------------------|
| 4 | 350 | 0.3 | 100 | 24 | 350 | 1.6 | 400 |
| 6 | 350 | 0.3 | 150 | 30 | 250 | 2.1 | 400 |
| 8 | 350 | 0.5 | 150 | 36 | 250 | 2.7 | 500 |
| 10 | 350 | 0.6 | 200 | 42 | 250 | 3.5 | 500 |
| 12 | 350 | 0.8 | 200 | 48 | 250 | 4.0 | 500 |
| 14 | 350 | 0.9 | 250 | 54 | 250 | 4.3 | 600 |
| 16 | 350 | 1.1 | 250 | 60 | 250 | 6.4 | 600 |
| 18 | 350 | 1.1 | 300 | 64 | 250 | 9.1 | 600 |
| 20 | 350 | 1.3 | 300 | - | - | - | - |

Notes:

*Pressure rating designated is maximum water working pressure and is based on the 350 psi allowable rating of 24” and smaller flanges in C111 and the 250 psi maximum rating of other sizes of C110 or C115 flanges. Contact AMERICAN on higher pressure or temperature requirements.

**Bolt torque applicable only to flanged joints with Toruseal® gaskets.

Clean flange faces and faced pipe ends thoroughly prior to installation. Do not use joint or gasket compounds with Toruseal® gaskets (assemble joints dry).

For use with standard flange bolts. Holes match AWWA C110, C111, and C115 flange drilling. They also match certain flange drilling classes of AWWA C207 and ANSI B16.1 and B16.42 flanges.

Toruseal® gaskets may be used with steel pipe flanges in the 14”-54” sizes in some cases. Check AMERICAN for details, or when connecting to any flange configured differently than flanges per AWWA C110 or C115.



AMERICAN Flanged Pipe Details and Accessories

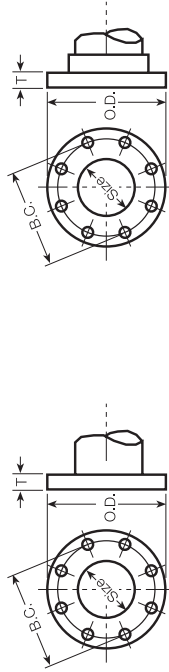

Cast-On Flange ANSI/AWWA C110/A21.10
Threaded-On Flange ANSI/AWWA C115/A21.15

Table No. 8-3

| Size in. | O.D. Flange in. | B.C. Bolt Circlelet in. | Thickness† in. | Bolt Hole Dia. in. | BOLTS AND STUDS | | | | Approx. Weight per Bolt lbs. |
|----------|-----------------|-------------------------|----------------|--------------------|-----------------|-----------------|-----------------|------------------|------------------------------|
| | | | | | No. per Joint | Bolt Size†† in. | Stud Size†† in. | Threads per inch | |
| 4 | 9.00 | 7.50 | .94 | 3/4 | 8 | 5/8 X 3 1/2 | 5/8 X 3 | 11 | .35 |
| 6 | 11.00 | 9.50 | 1.00 | 7/8 | 8 | 3/4 X 3 1/2 | 3/4 X 3 1/2 | 10 | .5 |
| 8 | 13.50 | 11.75 | 1.12 | 7/8 | 8 | 3/4 X 3 1/2 | 3/4 X 3 1/2 | 10 | .5 |
| 10 | 16.00 | 14.25 | 1.19 | 1 | 12 | 7/8 X 4 | 7/8 X 4 | 9 | .8 |
| 12 | 19.00 | 17.00 | 1.25 | 1 | 12 | 7/8 X 4 | 7/8 X 4 | 9 | .8 |
| 14 | 21.00 | 18.75 | 1.38 | 1 1/8 | 12 | 1 X 4 1/2 | 1 X 4 1/2 | 8 | 1.2 |
| 16 | 23.50 | 21.25 | 1.44 | 1 1/8 | 16 | 1 X 4 1/2 | 1 X 4 1/2 | 8 | 1.2 |
| 18 | 25.00 | 22.75 | 1.56 | 1 1/4 | 16 | 1 1/8 X 5 | 1 1/8 X 5 | 7 | 1.8 |
| 20 | 27.50 | 25.00 | 1.69 | 1 1/4 | 20 | 1 1/8 X 5 | 1 1/8 X 5 | 7 | 1.8 |
| 24 | 32.00 | 29.50 | 1.88 | 1 3/8 | 20 | 1 1/4 X 5 1/2 | 1 1/4 X 5 1/2 | 7 | 2.4 |
| 30 | 38.75 | 36.00 | 2.12 | 1 3/8 | 28 | 1 1/4 X 6 1/2 | 1 1/4 X 6 1/2 | 7 | 2.7 |
| 36 | 46.00 | 42.75 | 2.38 | 1 5/8 | 32 | 1 1/2 X 7 | 1 1/2 X 7 | 6 | 5.1 |
| 42 | 53.00 | 49.50 | 2.62 | 1 5/8 | 36 | 1 1/2 X 7 1/2 | 1 1/2 X 7 1/2 | 6 | 5.4 |
| 48 | 59.50 | 56.00 | 2.75 | 1 5/8 | 44 | 1 1/2 X 8 | 1 1/2 X 8 | 6 | 5.6 |
| 54 | 66.25 | 62.75 | 3.00 | 2 | 44 | 1 3/4 X 8 1/2 | 1 3/4 X 8 1/2 | 5 | 8.3 |
| 60 | 73.00 | 69.25 | 3.12 | 2 | 52 | 1 3/4 X 9 | 1 3/4 X 9 | 5 | 8.7 |
| *64 | 80.00 | 76.00 | 3.38 | 2 | 52 | 1 3/4 X 9 | 1 3/4 X 9 | 5 | 8.7 |

*The dimensions of 64" flange correspond with applicable dimensions of 66" Class E flange in ANSI/AWWA C207, and 64" ductile iron flanges can be connected to those flanges.

†Bolt circle and thickness tolerances are per AWWA C115.

††Bolts are hex head machine bolts with regular or heavy hex nuts as specified. Studs with one hex nut each are required for tapped flanges. Bolts, studs and nuts are low-carbon steel per ASTM A307, Grade B; threads are ANSIB1, 1 Coarse Thread Series, Class 2A external and Class 2B internal. Recommended studs are the same length as corresponding bolt length with "lap end" threaded approximately the same length as flange thickness.

Facing: Flanges are plain-faced without projection and are furnished smooth or with shallow serrations.

Back Facing: Flanges may be back-faced or spot-faced for compliance with the flange thickness tolerance.

Flanges: The flanges are adequate for water service of 250 psi working pressure or 350 psi in 4"-24" sizes when employing "Orusetal" gasket seats. The bolt circle and bolt holes match those of ANSI B16.1 Class 125 flanges and ANSI B16.5 Class 150 flanges. The flanges do not match and cannot be joined with the ANSI B16.1 Class 150 flanges or with other type flanges. Drilling of flanges can be rotated when required; for those sizes with an even number of bolt holes in each quadrant, pipe can be rotated 45° with standard drilling.

See Section 6 for dimensions of flanges larger than 64".



AMERICAN Flanged Pipe
Companion Flanges for Use
on Ductile Iron Pipe
ANSI/AWWA C115/A21.15

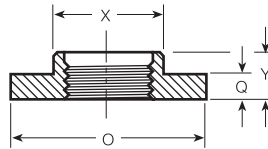

Ductile Companion Flange

Table No. 8-4

| Parent Pipe Size in. | Pipe O.D. | AWWA C115 | | | |
|----------------------|-----------|----------------------|-----------------|----------------|------------------------|
| | | O Dia. of Flange in. | Q Thickness in. | X Dia. Hub in. | Y Length incl. Hub in. |
| 4 | 4.80 | 9.00 | .94 | 6.00 | 1.88 |
| 6 | 6.90 | 11.00 | 1.00 | 7.78 | 2.06 |
| 8 | 9.05 | 13.50 | 1.12 | 10.01 | 2.25 |
| 10 | 11.10 | 16.00 | 1.19 | 12.31 | 2.44 |
| 12 | 13.20 | 19.00 | 1.25 | 14.75 | 2.68 |
| 14 | 15.30 | 21.00 | 1.38 | 16.59 | 2.87 |
| 16 | 17.40 | 23.50 | 1.44 | 18.94 | 3.06 |
| 18 | 19.50 | 25.00 | 1.56 | 20.38 | 3.31 |
| 20 | 21.60 | 27.50 | 1.69 | 22.62 | 3.50 |
| 24 | 25.80 | 32.00 | 1.88 | 26.91 | 3.93 |
| 30 | 32.00 | 38.75 | 2.12 | 33.31 | 4.50 |
| 36 | 38.30 | 46.00 | 2.38 | 39.62 | 5.12 |
| 42 | 44.50 | 53.00 | 2.62 | 46.00 | 5.75 |
| 48 | 50.80 | 59.50 | 2.75 | 52.31 | 6.38 |
| 54 | 57.56 | 66.25 | 3.00 | 58.75 | 7.00 |
| 60 | 61.61 | 73.00 | 3.12 | 63.76 | 7.00 |
| 64 | 65.67 | 80.00 | 3.38 | 70.32 | 7.00 |

Hub diameter and length are AMERICAN Design. See Table No. 8-3 for data on bolt holes and bolt circle. When ordering Companion Flanges for Ductile Iron Pipe specify the outside diameter of the pipe. "X" and "Y" dimensions may vary depending on foundry equipment.



AMERICAN Flanged Pipe
AMERICAN Ductile Iron Flanged Pipe
ANSI/AWWA C115/A21.15

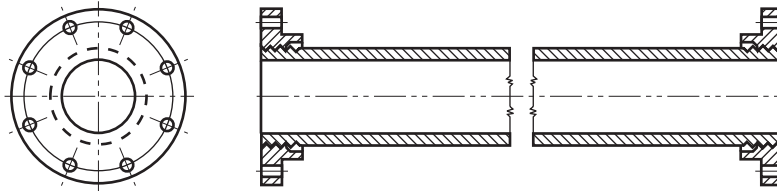

Flange and Flange

Table No. 8-5

| Size in. | Pressure* Rating psi | Nominal Wall Thickness in. | Pipe O.D. in. | Minimum Length** in. | Maximum Length** ft.-in. | Weight in Pounds | | |
|----------|----------------------|----------------------------|---------------|----------------------|--------------------------|--------------------|------------|-------------------------------------|
| | | | | | | Per Foot Plain End | One Flange | Per Maximum Length with Two Flanges |
| 4 | 350† | .32 | 4.80 | 4 1/2 | 20'-0" | 13.8 | 13 | 300 |
| 6 | 350† | .34 | 6.90 | 4 1/2 | 20'-0" | 21.4 | 17 | 460 |
| 8 | 350† | .36 | 9.05 | 4 1/2 | 20'-0" | 30.1 | 27 | 655 |
| 10 | 350† | .38 | 11.10 | 6 | 20'-0" | 39.2 | 38 | 860 |
| 12 | 350† | .40 | 13.20 | 6 | 20'-0" | 49.2 | 59 | 1100 |
| 14 | 350† | .42 | 15.30 | 7 | 20'-0" | 60.1 | 70 | 1340 |
| 16 | 350† | .43 | 17.40 | 7 | 20'-0" | 70.1 | 90 | 1580 |
| 18 | 350† | .44 | 19.50 | 7 | 20'-0" | 80.6 | 88 | 1790 |
| 20 | 350† | .45 | 21.60 | 7 | 20'-0" | 91.5 | 112 | 2060 |
| 24 | 350† | .47 | 25.80 | 8 | 20'-0" | 114.4 | 155 | 2600 |
| 30 | 250 | .51 | 32.00 | 12 | 19'-6" | 154.4 | 245 | 3500 |
| 36 | 250 | .58 | 38.30 | 14 | 19'-6" | 210.3 | 354 | 4810 |
| 42 | 250 | .65 | 44.50 | 18 | 19'-6" | 274.0 | 512 | 6370 |
| 48 | 250 | .72 | 50.80 | 18 | 19'-6" | 346.6 | 632 | 8020 |
| 54 | 250 | .81 | 57.56 | 20 | 19'-6" | 441.9 | 716 | 10050 |
| 60 | 250 | .83 | 61.61 | 20 | 19'-6" | 485.0 | 1113 | 11680 |
| 64 | 250 | .87 | 65.67 | 21 | 19'-0" | 542.0 | 1824 | 13950 |

*Pressure rating designated is maximum water working pressure. Contact AMERICAN on higher pressure requirements.

**Check AMERICAN if longer or shorter lengths required.

†This rating is only applicable to flanged joints utilizing AMERICAN Toruseal® gaskets as per page 8-3.

Pipe is available with greater wall thickness than shown. Thicknesses above correspond to Special Class 53 for 4"-54" diameters, and Pressure Class 350 for 60" and 64" diameters as shown in AWWA C151.

Any length between minimum and maximum shown can be furnished.

Tolerance on length is ±0.12 in.

Standard drilling is with bolt holes aligned, straddling a common centerline. Special drilling can be furnished on request.

Where required, specify flanges "Tap for Studs."

The bolt circle and bolt holes of AWWA C115 flanges, AWWA C110 flanges and ANSI B16.1 Class 125 flanges are identical, and these flanges can be joined. AWWA C115 and AWWA C110 flanges are rated for 250-350 psi water working pressure depending on size and specified gasketing system.



AMERICAN Flanged Pipe
AMERICAN Ductile Iron Flanged Pipe
ANSI/AWWA C115/A21.15

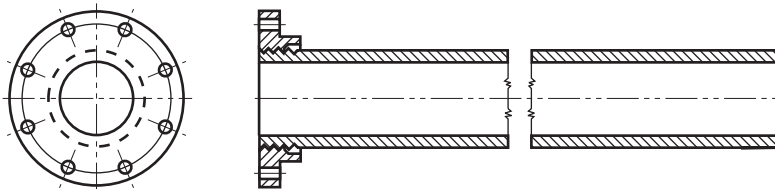

Flange and Plain End

Table No. 8-6

| Size in. | Pressure* Rating psi | Nominal Wall Thickness in. | Pipe O.D. in. | Minimum Length** in. | Maximum Length** ft.-in. | Weight in Pounds | | |
|----------|----------------------|----------------------------|---------------|-------------------------------|--------------------------|--------------------|------------|------------------------------------|
| | | | | | | Per Foot Plain End | One Flange | Per Maximum Length with One Flange |
| 4 | 350† | .32 | 4.80 | 1 ³ / ₄ | 20'-0" | 13.8 | 13 | 285 |
| 6 | 350† | .34 | 6.90 | 2 | 20'-0" | 21.4 | 17 | 445 |
| 8 | 350† | .36 | 9.05 | 2 ¹ / ₂ | 20'-0" | 30.1 | 27 | 630 |
| 10 | 350† | .38 | 11.10 | 2 ¹ / ₂ | 20'-0" | 39.2 | 38 | 820 |
| 12 | 350† | .40 | 13.20 | 2 ¹ / ₂ | 20'-0" | 49.2 | 59 | 1045 |
| 14 | 350† | .42 | 15.30 | 2 ³ / ₄ | 20'-0" | 60.1 | 70 | 1270 |
| 16 | 350† | .43 | 17.40 | 3 | 20'-0" | 70.1 | 90 | 1490 |
| 18 | 350† | .44 | 19.50 | 3 | 20'-0" | 80.6 | 88 | 1700 |
| 20 | 350† | .45 | 21.60 | 3 | 20'-0" | 91.5 | 112 | 1950 |
| 24 | 350† | .47 | 25.80 | 3 ³ / ₄ | 20'-0" | 114.4 | 155 | 2450 |
| 30 | 250 | .51 | 32.00 | 8 | 19'-6" | 154.4 | 245 | 3260 |
| 36 | 250 | .58 | 38.30 | 10 | 19'-6" | 210.3 | 354 | 4450 |
| 42 | 250 | .65 | 44.50 | 10 | 19'-6" | 274.0 | 512 | 5850 |
| 48 | 250 | .72 | 50.80 | 10 | 19'-6" | 346.6 | 632 | 7390 |
| 54 | 250 | .81 | 57.56 | 12 | 19'-6" | 441.9 | 716 | 9330 |
| 60 | 250 | .83 | 61.61 | 12 | 19'-6" | 485.0 | 1113 | 10570 |
| 64 | 250 | .87 | 65.67 | 12 | 19'-0" | 542.0 | 1824 | 12120 |

*Pressure rating designated is maximum water working pressure. Contact AMERICAN on higher pressure requirements.

**Check AMERICAN if longer or shorter lengths required. All minimum lengths assume a "no-gauge" plain end (no joint will be made at the plain end).

†This rating is only applicable to flanged joints utilizing AMERICAN Toruseal® gaskets as per page 8-3.

Plain ends to be assembled in a joint (MJ, Fastite, coupling, etc.) must be ordered gauged for the specific joint.

Pipe is available with greater wall thickness than shown. Thicknesses above correspond to Special Class 53 for 4"-54" diameters, and Pressure Class 350 for 60" and 64" diameters as shown in AWWA C151.

Any length between minimum and maximum shown can be furnished.

Tolerance on length is ±0.25 in.

Where required, specify flanges "Tap for Studs."

The bolt circle and bolt holes of AWWA C115 flanges, AWWA C110 flanges and ANSI B16.1 Class 125 flanges are identical, and these flanges can be joined. AWWA C115 and AWWA C110 flanges are rated for 250-350 psi water working pressure depending on size and specified gasketing system.



AMERICAN Flanged Pipe
AMERICAN Ductile Iron Flanged Pipe
ANSI/AWWA C115/A21.15 and AMERICAN Standard

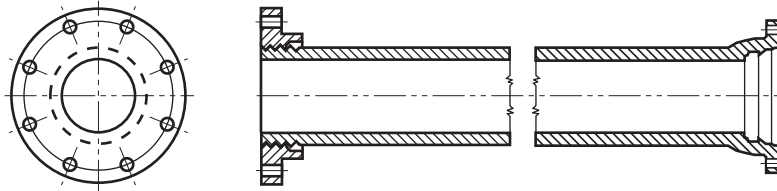

Flange and MJ

Table No. 8-7

| Size in. | Pressure Rating psi* | Nominal Wall Thickness in. | Pipe O.D. in. | Minimum Laying Length** in. | Maximum Laying Length** ft.-in. | Weight in Pounds | | | |
|----------|----------------------|----------------------------|---------------|---------------------------------|---------------------------------|--------------------|--------|---------|----------------|
| | | | | | | Per Foot Plain End | Flange | MJ Bell | Maximum Length |
| 4 | 350† | .32 | 4.80 | 113 ¹ / ₂ | 19'-6" | 13.8 | 13 | 14 | 295 |
| 6 | 350† | .34 | 6.90 | 113 ¹ / ₂ | 19'-6" | 21.4 | 17 | 19 | 455 |
| 8 | 350† | .36 | 9.05 | 113 ¹ / ₂ | 19'-6" | 30.1 | 27 | 25 | 640 |
| 10 | 350† | .38 | 11.10 | 116 | 19'-6" | 39.2 | 38 | 31 | 835 |
| 12 | 350† | .40 | 13.20 | 116 | 19'-6" | 49.2 | 59 | 38 | 1055 |

*Pressure rating designated is maximum water working pressure. Contact AMERICAN on higher pressure requirements.

**Check AMERICAN if longer or shorter lengths required.

†This rating is only applicable to flanged joints utilizing AMERICAN Toruseal® gaskets as per page 8-3.

14"-64" pipe is not available with integrally cast MJ Bell. See Table 8-8 for Flange and Fastite Pipe.

Pipe is available with greater wall thickness than shown. Thicknesses above correspond to Special Class 53.

Any length between minimum and maximum shown can be furnished.

Tolerance on length is ±0.25 in.

If specified, bolt holes both ends can be drilled, straddling a common centerline.

Where required, specify flanges or MJ Bells "Tap for Studs."

The bolt circle and bolt holes of AWWA C115 flanges, AWWA C110 flanges and ANSI B16.1 Class 125 flanges are identical, and these flanges can be joined. AWWA C115 and AWWA C110 flanges are rated for 250-350 psi water working pressure depending on size and specified gasketing system.



AMERICAN Flanged Pipe
AMERICAN Ductile Iron Flanged Pipe
ANSI/AWWA C115/A21.15 and AMERICAN Standard

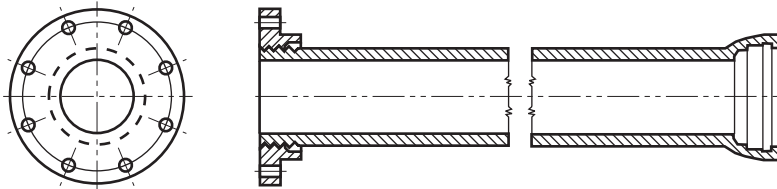

Flange and Fastite

Table No. 8-8

| Size in. | Pressure Rating psi* | Nominal Wall Thickness in. | Pipe O.D. in. | Minimum Laying Length** in. | Maximum Laying Length** ft.-in. | Weight in Pounds | | | |
|----------|----------------------|----------------------------|---------------|-----------------------------|---------------------------------|--------------------|--------|--------------|----------------|
| | | | | | | Per Foot Plain End | Flange | Fastite Bell | Maximum Length |
| 4 | 350† | .32 | 4.80 | 2½ | 19'-6" | 13.8 | 13 | 10 | 290 |
| 6 | 350† | .34 | 6.90 | 2½ | 19'-6" | 21.4 | 17 | 15 | 450 |
| 8 | 350† | .36 | 9.05 | 3 | 19'-6" | 30.1 | 27 | 21 | 635 |
| 10 | 350† | .38 | 11.10 | 2 | 19'-6" | 39.2 | 38 | 27 | 830 |
| 12 | 350† | .40 | 13.20 | 2 | 19'-6" | 49.2 | 59 | 32 | 1050 |
| 14 | 350† | .42 | 15.30 | 2¾ | 19'-6" | 60.1 | 70 | 57 | 1300 |
| 16 | 350† | .43 | 17.40 | 2¾ | 19'-6" | 70.1 | 90 | 64 | 1520 |
| 18 | 350† | .44 | 19.50 | 3 | 19'-6" | 80.6 | 88 | 73 | 1735 |
| 20 | 350† | .45 | 21.60 | 3 | 19'-6" | 91.5 | 112 | 81 | 1980 |
| 24 | 350† | .47 | 25.80 | 2¾ | 19'-6" | 114.4 | 155 | 96 | 2480 |
| 30 | 250 | .51 | 32.00 | 12 | 19'-6" | 154.4 | 245 | 164 | 3420 |
| 36 | 250 | .58 | 38.30 | 14 | 19'-6" | 210.3 | 354 | 214 | 4670 |
| 42 | 250 | .65 | 44.50 | 14 | 19'-6" | 274.0 | 512 | 289 | 6140 |
| 48 | 250 | .72 | 50.80 | 16 | 19'-6" | 346.6 | 632 | 354 | 7745 |
| 54 | 250 | .81 | 57.56 | 16 | 19'-6" | 441.9 | 716 | 439 | 9770 |
| 60 | 250 | .83 | 61.61 | 16 | 19'-6" | 485.0 | 1113 | 819 | 11390 |
| 64 | 250 | .87 | 65.67 | 16 | 19'-6" | 542.0 | 1824 | 932 | 13320 |

*Pressure rating designated is maximum water working pressure. Contact AMERICAN on higher pressure requirements.

**Check AMERICAN if longer or shorter lengths required.

†This rating is only applicable to flanged joints utilizing AMERICAN Toruseal® gaskets as per page 8-3.

Pipe is available with greater wall thickness than shown. Thicknesses above correspond to Special Class 53 for 4"-54" diameters, and Pressure Class 350 for 60" and 64" diameters as shown in AWWA C151.

Any length between minimum and maximum shown can be furnished.

Tolerance on length is ±0.25 in.

Where required, specify flanges "Tap for Studs."

The bolt circle and bolt holes of AWWA C115 flanges, AWWA C110 flanges and ANSI B16.1 Class 125 flanges are identical, and these flanges can be joined. AWWA C115 and AWWA C110 flanges are rated for 250-350 psi water working pressure depending on size and specified gasketing system.



AMERICAN Flanged Pipe Short Lengths Statically Cast Ductile Iron Spools Minimum Lengths

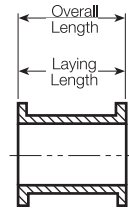

Flange and Flange

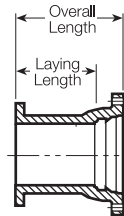

Flange and MJ

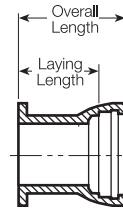

Flange and Fastite

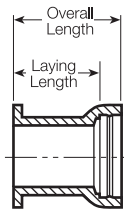

Flange and Lok-Ring

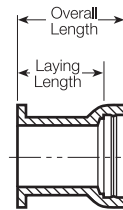

Flange and Flex-Ring

Table No. 8-9

| Size in. | Minimum Lengths | | | | | | | | | |
|-------------|--------------------------------|--------------------------------|------------------|-------------------------------------|------------------|-------------------------------------|-------------------|-------------------------------------|--------------------|-------------------------------------|
| | Flange & Flange | | Flange & MJ | | Flange & Fastite | | Flange & Lok-Ring | | Flange & Flex-Ring | |
| | Laying Length | Overall Length | Laying Length | Overall Length | Laying Length | Overall Length | Laying Length | Overall Length | Laying Length | Overall Length |
| 30 | 18 ³ / ₄ | 18 ¹ / ₄ | 0'-10" | 1'-12 ¹ / ₂ " | 0'-10" | 1'-13 ¹ / ₄ " | N/A | N/A | 0'-10" | 1'-7 ³ / ₈ " |
| 36 | 18 ³ / ₄ | 18 ³ / ₄ | 0'-10" | 1'-12 ¹ / ₂ " | 0'-10" | 1'-13 ¹ / ₄ " | N/A | N/A | 0'-10" | 1'-7 ³ / ₈ " |
| 42 | 10 ¹ / ₄ | 10 ¹ / ₄ | 0'-10" | 1'-12 ¹ / ₂ " | 0'-10" | 1'-15 ¹ / ₂ " | N/A | N/A | 0'-10" | 1'-8 ⁷ / ₈ " |
| 48 | 10 ¹ / ₂ | 10 ¹ / ₂ | 0'-10" | 1'-12 ¹ / ₂ " | 0'-10" | 1'-16 ¹ / ₂ " | N/A | N/A | 0'-10" | 1'-10 ³ / ₈ " |
| 54 | 12 ¹ / ₂ | 12 ¹ / ₂ | N/A | N/A | 0'-10" | 1'-16 ¹ / ₂ " | 0'-10" | 1'-18 ¹ / ₂ " | N/A | N/A |
| 60 | 12 ¹ / ₂ | 12 ¹ / ₂ | N/A | N/A | 0'-10" | 1'-16 ³ / ₄ " | 0'-10" | 1'-18 ¹ / ₂ " | N/A | N/A |
| 64 | 12 ¹ / ₂ | 12 ¹ / ₂ | N/A | N/A | 0'-10" | 1'-17 ¹ / ₂ " | 0'-10" | 1'-18 ¹ / ₂ " | N/A | N/A |

Flanges are AWWA C110.
 Shorter lengths are furnished as Flange Fillers. See Section 6, Table No. 6-18.
 All sizes and lengths of Flange and Plain End, MJ and Plain End, Fastite and Plain End, and Plain End and Plain End Pipe are generally fabricated from centrifugally cast pipe.
 Some sizes of pipe in shorter lengths than shown above can be furnished statically cast by special pattern adaptation.
 Statically cast flanged spools are made of ductile iron and are pressure rated 250 psi. Contact AMERICAN on higher pressure or longer/shorter length requirements.



AMERICAN Flanged Pipe Short Lengths Statically Cast Ductile Iron Spools Maximum Lengths

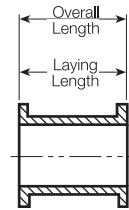

Flange and Flange

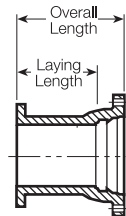

Flange and MJ

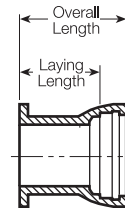

Flange and Fastite

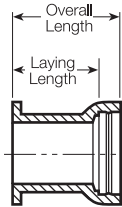

Flange and Lok-Ring

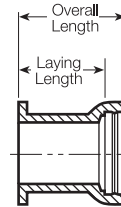

Flange and Flex-Ring

Table No. 8-10

| Size in. | Maximum Lengths | | | | | | | | | |
|-------------|------------------|-------------------|------------------|------------------------------------|------------------|-------------------------------------|-------------------|-------------------------------------|--------------------|-------------------------------------|
| | Flange & Flange | | Flange & MJ | | Flange & Fastite | | Flange & Lok-Ring | | Flange & Flex-Ring | |
| | Laying Length | Overall Length | Laying Length | Overall Length | Laying Length | Overall Length | Laying Length | Overall Length | Laying Length | Overall Length |
| 30 | 1'-6" | 1'-6" | 3'-0" | 3'-4 ¹ / ₂ " | 3'-0" | 3'-15 ¹ / ₄ " | N/A | N/A | 3'-0" | 3'-19 ³ / ₈ " |
| 36 | 1'-6" | 1'-6" | 3'-0" | 3'-4 ¹ / ₂ " | 3'-0" | 3'-15 ¹ / ₄ " | N/A | N/A | 3'-0" | 3'-19 ³ / ₈ " |
| 42 | 1'-6" | 1'-6" | 3'-0" | 3'-4 ¹ / ₂ " | 3'-0" | 3'-17 ¹ / ₂ " | N/A | N/A | 5'-8" | 6'-16 ³ / ₈ " |
| 48 | 1'-6" | 1'-6" | 3'-0" | 3'-4 ¹ / ₂ " | 3'-0" | 3'-18 ¹ / ₂ " | N/A | N/A | 5'-8" | 6'-18 ³ / ₈ " |
| 54 | 2'-0" | 2'-0" | N/A | N/A | 3'-0" | 3'-18 ¹ / ₂ " | 3'-0" | 3'-10 ¹ / ₂ " | N/A | N/A |
| 60 | 2'-0" | 2'-0" | N/A | N/A | 3'-0" | 3'-18 ³ / ₄ " | 3'-0" | 3'-10 ¹ / ₂ " | N/A | N/A |
| 64 | 2'-0" | 2'-0" | N/A | N/A | 3'-0" | 3'-19 ¹ / ₂ " | 3'-0" | 3'-10 ¹ / ₂ " | N/A | N/A |

Flanges are AWWA C110.

Longer lengths of Flange and Flange, Flange and MJ, Flange and Fastite, Flange and Lok-Ring, and Flange and Flex-Ring Pipe than shown above are normally fabricated from centrifugally cast pipe. Lengths shorter than the maximum shown above may also be fabricated from centrifugally cast pipe.

All sizes and lengths of Flange and Plain End, MJ and Plain End, Fastite and Plain End, and Plain End and Plain End Pipe are generally fabricated from centrifugally cast pipe.

To determine weight of any statically cast pipe with various joint combinations and lengths, use data in Section 7, Table No. 7-3.

Some sizes of pipe in longer lengths than shown above can be furnished statically cast by special pattern adaptation.

Statically cast flanged spools are made of ductile iron and are pressure rated 250 psi. Contact AMERICAN on higher pressure requirements.



AMERICAN DUCTILE IRON PIPE

**AMERICAN Flanged Pipe
Flex-Ring X Flange Adapter**

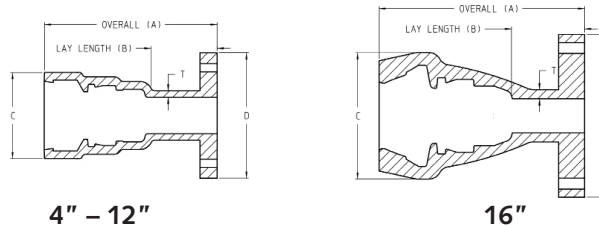

Table No. 8-11

| Size | Laying Length (B) | Overall Length (A) | T | Flex-Ring Bell (C) | Flange Diameter (D) | Weight |
|------|-------------------|--------------------|------|--------------------|---------------------|--------|
| 4 | 4.00 | 9.71 | 0.34 | 7.18 | 9.00 | 45 |
| 6 | 4.00 | 9.71 | 0.36 | 9.20 | 11.00 | 65 |
| 8 | 4.00 | 9.83 | 0.38 | 11.35 | 13.50 | 80 |
| 10 | 4.00 | 10.74 | 0.40 | 13.75 | 16.00 | 125 |
| 12 | 4.00 | 10.74 | 0.42 | 16.37 | 19.00 | 165 |
| 16 | 4.00 | 11.38 | 0.50 | 21.49 | 23.50 | 260 |

Notes:

1. All dimensions are in inches.
2. Casting manufactured in accordance with ANSI/AWWA C153/A21.53.
3. Material ductile iron as specifies by ANSI/AWWA C153/A21.53.
4. Marking per ANSI/AWWA C153/A21.53.
5. Flanges per AWWA/ANSI C110/A21.10 and ASME B16.1 Class 125.

**AMERICAN Flanged Pipe
Ductile Iron Welded Flange
Class 125 Welded Flange Dimensions**

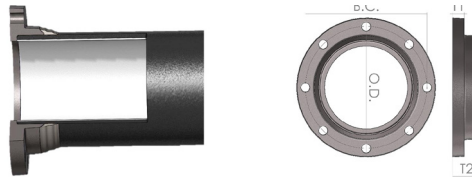

Welded flanges may be used on flanged outlets and pipes in sizes 4-inch through 36-inch. The ductile iron class 125 flange is produced in accordance with the requirements of ANSI/AWWA C115/A21.15 and ASME B16.1. Class 250 ductile iron flanges can be furnished upon request. Class 125 welded flanges are rated for 250 psi working pressure. Class 125 welded flanges 4-inch through 24-inch are rated up to a maximum working pressure of 350 psi when a Toruseal gasket is used. In performance evaluations, for both pressure testing and long-span moment loaded testing, all welded flanges currently offered perform equal to or better than threaded flanges. The AWS weld wire designation used in fabrication is ENiFeT3-CI. Stooddy Castweld Ni55 is the current approved wire.

This information covers the specification requirements for purchased ductile iron weld-on flanges in accordance with the latest revisions of ANSI/AWWA C115/A21.15, C110/A21.10, and/or ASME B16.1, as applicable.

Material, Metallurgical, and Mechanical Requirements

Weld-on flanges shall be made of ductile iron conforming to the mechanical

requirements of C110/A21.10 and ASTM A536, ductile iron grade 65-45-12. Ductile iron grades 70-50-05 and 60-40-12 may be allowed with approval by the purchaser. The ductile iron shall meet the chemical requirements shown in ANSI/AWWA C110/A21.10, Section 5.5.2 and/or ANSI/AWWA C153/A21.53, Section 5.3 (phosphorous <0.08%). Hollow-back flanges are not acceptable.



Table No. 8-12

| Size in. | O.D. Flange in. | B.C. Bolt Circle in. | T1: Flange Thickness in. | T2: Overall Thickness in. | Bolt Hole Diameter in. | Number of Bolt Holes | Approx. Weight Pounds |
|----------|-----------------|----------------------|--------------------------|---------------------------|------------------------|----------------------|-----------------------|
| 4 | 9.00 | 7.50 | .94 | 2.56 | 0.750 | 8 | 15 |
| 6 | 11.00 | 9.50 | 1.01 | 2.64 | 0.875 | 8 | 19 |
| 8 | 13.50 | 11.75 | 1.12 | 2.68 | 1.000 | 8 | 28 |
| 10 | 16.00 | 14.25 | 1.19 | 2.80 | 1.000 | 12 | 40 |
| 12 | 19.00 | 17.00 | 1.25 | 2.93 | 1.125 | 12 | 59 |
| 14 | 21.00 | 18.75 | 1.38 | 3.11 | 1.125 | 12 | 69 |
| 16 | 23.50 | 21.25 | 1.44 | 3.31 | 1.125 | 16 | 87 |
| 18 | 25.00 | 22.75 | 1.57 | 3.44 | 1.125 | 16 | 85 |
| 20 | 27.50 | 25.00 | 1.69 | 3.56 | 1.125 | 20 | 108 |
| 24 | 32.00 | 29.50 | 1.88 | 3.81 | 1.375 | 20 | 145 |
| 30 | 38.75 | 36.00 | 2.12 | 3.93 | 1.375 | 28 | 210 |
| 36 | 46.00 | 42.75 | 2.38 | 4.05 | 1.625 | 32 | 301 |

Casting Surface Quality

Castings shall conform to the Surface Finish Number, or a lower number, according to MSS SP-112 Quality Standard for Evaluation of Cast Surface Finishes.

OD Surface Finishes: External Surfaces of castings shall conform to Surface Finish Number 5 with the allowance that a maximum of 30% of the total surface area may conform to Number 7.

Protruding Metal: Protruding extra metal, including, but not limited to, flash at parting lines and core assembly joints, chaplets, gate and riser pads and core-surface burn-in, shall be ground flush with the surrounding surfaces such that the final ring is capable to pass the relevant sized go/no-go cross section gauge.

Voids, shrinkage, inclusions, and porosity: Voids, Shrinkage, Inclusions, and Porosity located on cast surfaces shall be acceptable according to the Definition of Surface Quality by Visual Examination for Types II, III, IV, and VII, in MSS SP-55.

Grind Marks: Grind marks shall be acceptable according to the Definition of Surface Quality by Visual Examination for Type VIIIa in MSS SP-55.

Fabrication

Machined surfaces shall be free of any voids, protruding metal, inclusions, or porosity. The repair of defects by plugging or welding is not allowed on castings and machined surfaces.

Coatings and Linings

Coatings and linings shall be as specified on the purchase order. A rust preventative coating shall be applied to the machined faces of the flanges. The coating must be easily removable by a solvent prior to welding.

Markings

The flange manufacturer's mark, country where cast, flange size, and the letters "DI" shall be cast or stamped with metal die on the back face of the flanges. In addition, "B16.1" and the relevant class designation number shall be cast or stamped on the flanges per the requirements listed in ASME B16.1, section 5.2 unless otherwise specified by the customer.

Referenced Documents

- ANSI/AWWA C115/A21.15-11 "Flanged Ductile-Iron Pipe with Ductile-Iron or Gray-Iron Threaded Flanges"
- ANSI/AWWA C151/A21.51-17 "Ductile-Iron Pipe, Centrifugally Cast"
- ANSI/AWWA C110/A21.10-12 "Ductile-Iron and Gray-Iron Fittings"
- ANSI/ASME B1.20.1 "Pipe Threads, General Purpose, Inch" (2013)
- ANSI/AWWA C104/A21.04-16 "Cement-Mortar Lining for Ductile-Iron Pipe and Fittings"
- ISO 2531:2009 "Ductile iron pipes, fittings, accessories and their joints for water applications"
- ISO 7005-2:1988 "Metallic flanges — Part 2: Cast iron flanges"
- MSS SP 9 2018 "Spot Facing for Bronze, Iron, and Steel Flanges" (2018)



AMERICAN Flanged Pipe—Flange Details and Accessories

Faced and Drilled Per ANSI B16.1 Class 25

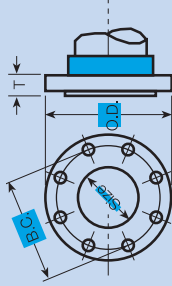

Threaded-On Flange
Faced and Drilled Per ANSI B16.1 Class 250

Table No. 8-12

| Size in. | O.D. Flange in. | B.C. Bolt Circle in. | T Thickness in. | Dia. of Raised Face in. | Bolt Hole Dia. in. | BOLTS AND STUDS | | | | Size Ring Gasket in. |
|-------------|-----------------------|----------------------------|-----------------------|-------------------------------|--------------------------|------------------|-------------------|-------------------|---------------------|----------------------------|
| | | | | | | No. per Joint | Bolt Size* in. | Stud Size* in. | Threads per inch | |
| 4 | 10.00 | 7.88 | 1.25 | 6.94 | 1 7/8 | 8 | 1 3/4 x 13 3/4 | 1 3/4 x 13 3/4 | 10 1/2 | 14 x 17 1/8 |
| 6 | 12.50 | 10.62 | 1.44 | 9.69 | 1 7/8 | 12 | 1 3/4 x 14 1/2 | 1 3/4 x 14 1/2 | 10 1/2 | 16 x 19 7/8 |
| 8 | 15.00 | 13.00 | 1.62 | 11.94 | 1 1/2 | 12 | 1 7/8 x 14 1/2 | 1 7/8 x 14 1/2 | 19 1/2 | 18 x 12 1/8 |
| 10 | 17.50 | 15.25 | 1.88 | 14.06 | 1 1/8 | 16 | 1 1/2 x 15 1/2 | 1 1/2 x 15 1/4 | 18 1/2 | 10 x 14 1/4 |
| 12 | 20.50 | 17.75 | 2.00 | 16.44 | 1 1/4 | 16 | 1 1/8 x 15 1/2 | 1 1/4 x 15 1/2 | 17 1/2 | 12 x 16 5/8 |
| 14 | 23.00 | 20.25 | 2.12 | 18.94 | 1 1/4 | 20 | 1 1/8 x 16 1/2 | 1 1/8 x 16 1/2 | 17 1/2 | 14 x 19 1/8 |
| 16 | 25.50 | 22.50 | 2.25 | 21.06 | 1 3/8 | 20 | 1 1/4 x 16 1/2 | 1 1/4 x 16 1/2 | 17 1/2 | 16 x 21 1/4 |
| 18 | 28.00 | 24.75 | 2.38 | 23.31 | 1 3/8 | 24 | 1 1/4 x 16 1/2 | 1 1/4 x 16 1/2 | 17 1/2 | 18 x 23 1/2 |
| 20 | 30.50 | 27.00 | 2.50 | 25.56 | 1 3/8 | 24 | 1 1/4 x 17 1/2 | 1 1/4 x 17 1/2 | 17 1/2 | 20 x 25 3/4 |
| 24 | 36.00 | 32.00 | 2.75 | 30.31 | 1 5/8 | 24 | 1 1/2 x 17 1/2 | 1 1/2 x 17 1/2 | 16 1/2 | 24 x 30 1/2 |
| 30 | 43.00 | 39.25 | 3.00 | 37.19 | 2 1/2 | 28 | 1 3/4 x 18 1/2 | 1 3/4 x 18 1/2 | 15 1/2 | 30 x 37 1/2 |
| 36 | 50.00 | 46.00 | 3.38 | 43.69 | 2 1/4 | 32 | 2 1/2 x 19 1/2 | 2 1/2 x 19 1/2 | 14 1/2 | 36 x 44 1/2 |
| 42 | 57.00 | 52.75 | 3.69 | 50.44 | 2 1/4 | 36 | 2 1/2 x 10 1/2 | 2 1/2 x 10 1/2 | 14 1/2 | 42 x 50 3/4 |
| 48 | 65.00 | 60.75 | 4.00 | 58.44 | 2 1/4 | 40 | 2 1/2 x 11 1/2 | 2 1/2 x 10 3/4 | 14 1/2 | 48 x 58 3/4 |

*Bolts are hex head machine bolts with regular or heavy hex nuts as specified. Studs with one hex nut each are required for tapped flanges. Bolts, studs and nuts are low-carbon steel per ASTM A307; threads are ANSI B1.1 Coarse Thread Series, Class 2A external and Class 2B internal. Recommended studs are the same length as corresponding bolt length with "tap end" threaded approximately the same length as flange thickness.

Facing: Flanges have a 0.06" raised face and are furnished with shallow serrations. Flanges may be furnished with a flat face upon special request.

Back Facing: Flanges may be back-faced or spot-faced for compliance with the flange thickness tolerance.

Flanges: The flanges are adequate for water service of 250 psi working pressure. The bolt circle and bolt holes do not match those of AWWA C115 or C110 flanges. Drilling of flanges can be rotated when required; for those sizes with an even number of bolt holes in each quadrant, pipe can be rotated 45° with standard drilling.



AMERICAN Flanged Pipe
Companion Flanges for Use
on Ductile Iron Pipe
Faced and Drilled Per ANSI B16.1 Class 250

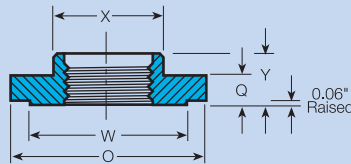

Table No. 8-13

| Size in. | Pipe O.D. in. | Flanges Faced and Drilled Per ANSI B16.1 Class 250 | | | | |
|----------|---------------|--|-----------------|---------------------------|-------------------|------------------------|
| | | O Dia. of Flange in. | Q Thickness in. | W Dia. of Raised Face in. | X Dia. of Hub in. | Y Length incl. Hub in. |
| 4 | 4.80 | 10.00 | 1.25 | 6.94 | 6.00 | 2.12 |
| 6 | 6.90 | 12.50 | 1.44 | 9.69 | 8.50 | 2.31 |
| 8 | 9.05 | 15.00 | 1.62 | 11.94 | 10.78 | 2.50 |
| 10 | 11.10 | 17.50 | 1.88 | 14.06 | 12.81 | 2.68 |
| 12 | 13.20 | 20.50 | 2.00 | 16.44 | 15.13 | 2.93 |
| 14 | 15.30 | 23.00 | 2.12 | 18.94 | 17.50 | 3.12 |
| 16 | 17.40 | 25.50 | 2.25 | 21.06 | 19.56 | 3.31 |
| 18 | 19.50 | 28.00 | 2.38 | 23.31 | 21.75 | 3.56 |
| 20 | 21.60 | 30.50 | 2.50 | 25.56 | 24.00 | 3.75 |
| 24 | 25.80 | 36.00 | 2.75 | 30.31 | 28.50 | 4.18 |
| 30 | 32.00 | 43.00 | 3.00 | 37.19 | 35.00 | 4.75 |
| 36 | 38.30 | 50.00 | 3.38 | 43.69 | 41.25 | 5.37 |
| 42 | 44.50 | 57.00 | 3.69 | 50.44 | 48.50 | 6.00 |
| 48 | 50.80 | 65.00 | 4.00 | 58.44 | 56.55 | 6.63 |

Flanges faced and drilled per ANSI B16.1 Class 250 have a 0.06" raised face; they do not match AWWA C110 or C115 flanges. Flanges may be furnished with a flat face upon special request.
 Hub diameter and length are AMERICAN Design. See Table No. 8-11 for data on bolt holes and bolt circle.
 When ordering Companion Flanges for Ductile Iron Pipe specify the outside diameter of the pipe.



AMERICAN Flanged Pipe
AMERICAN Ductile Iron Flanged Pipe
Flanges Faced & Drilled
ANSI/AWWA C115/A21.15 & ANSI B16.1 Class 250

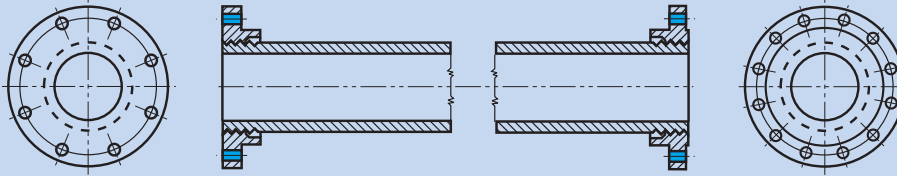

Flange and Flange
 C115 to B16.1 Class 250 Transition Pipe

Table No. 8-14

| Size in. | Pressure Rating** psi | Nominal Wall Thickness in. | Pipe O.D. in. | Minimum Laying Length in.* | Maximum Laying Length ft.-in. | Weight in Pounds | | | |
|----------|-----------------------|----------------------------|---------------|----------------------------|-------------------------------|--------------------|-------------|------------------|-----------------------|
| | | | | | | Per Foot Plain End | C115 Flange | B16.1 250 Flange | Min. Length Total Wt. |
| 4 | 250 | .32 | 4.80 | 6 | 19'-6" | 13.8 | 13 | 20 | 40 |
| 6 | 250 | .34 | 6.90 | 6 | 20'-0" | 21.4 | 17 | 32 | 60 |
| 8 | 250 | .36 | 9.05 | 6 | 20'-0" | 30.1 | 27 | 49 | 91 |
| 10 | 250 | .38 | 11.10 | 8 | 20'-0" | 39.2 | 38 | 68 | 132 |
| 12 | 250 | .40 | 13.20 | 8 | 20'-0" | 49.2 | 59 | 99 | 191 |
| 14 | 250 | .42 | 15.30 | 10 | 20'-0" | 60.1 | 70 | 127 | 247 |
| 16 | 250 | .43 | 17.40 | 10 | 20'-0" | 70.1 | 90 | 157 | 305 |
| 18 | 250 | .44 | 19.50 | 10 | 20'-0" | 80.6 | 88 | 194 | 349 |
| 20 | 250 | .45 | 21.60 | 10 | 20'-0" | 91.5 | 112 | 239 | 427 |
| 24 | 250 | .47 | 25.80 | 10 | 20'-0" | 114.4 | 155 | 358 | 608 |
| 30 | 250 | .51 | 32.00 | 12 | 19'-6" | 154.4 | 245 | 508 | 907 |
| 36 | 250 | .58 | 38.30 | 14 | 19'-6" | 210.3 | 354 | 697 | 1296 |
| 42 | 250 | .65 | 44.50 | 18 | 19'-6" | 274.0 | 512 | 1010 | 1933 |
| 48 | 250 | .72 | 50.80 | 18 | 19'-6" | 346.6 | 632 | 1545 | 2697 |

*The minimum lengths shown may not allow clearance in all cases for installation of bolts between flanges, requiring bolt clearance from the other direction. Very short (shorter than the minimums as per above table) fabricated steel adapters are also available for connecting AWWA C115 flanged pipe or AWWA C110 fittings to ANSI B16.1 Class 250 flanged items. Contact AMERICAN for details.

Pressure rating designated is maximum water working pressure.
 Flanges faced and drilled per ANSI B16.1 Class 250 have 0.06" raised face; they do not match AWWA C110 or C115 flanges. Flanges may be furnished with a flat face upon special request.

Pipe is available with greater wall thickness than shown.
 Tolerance on length for Flange and Flange pipe is ±0.12 in.
 Standard drilling is with bolt holes aligned, straddling a common centerline. Class 250 is special drilling and all connecting equipment must have flanges faced and drilled per ANSI B16.1 Class 250.
 Where required, specify flanges "Tap for Studs."

Section 9

AMERICAN Restrained Joint Pipe





AMERICAN Restrained Joint Pipe

The principal standards relating to applicable features of AMERICAN Restrained Joint Pipe and Fittings are ANSI/AWWA C151/A21.51, ANSI/AWWA C110/A21.10, ANSI/AWWA C111/A21.11 and ANSI/AWWA C153/A21.53. These and other standards are referenced throughout this Section either by the full ANSI/AWWA designation or by only the AWWA numbering, such as AWWA C151.

In many piping installations, the restraining of forces due to internal pressure at fittings, valves, or dead ends is a major consideration. In most underground piping, the restraining of such forces is normally accomplished by concrete reaction blocking, which generally provides the most economical and practical means of pipeline restraint.

In some situations concrete reaction blocking is not practical. For such projects*, AMERICAN has developed pipe joints that provide restraint against external forces or against separation due to internal pressure. Restrained joints are provided in all sizes 4" through 64" as shown below and described in this Section.

4"-12" Flex-Ring® Joint



Fast-Grip® Joint



14"-54" Flex-Ring® Joint



Lok-Ring® Joint



Field Flex-Ring® Joint



MJ Coupled Joint

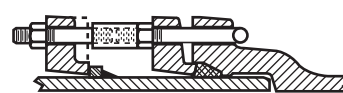

The following joints provide restraint but are not generally furnished primarily for the restraining feature:

Flange Joint—See Sections 6 and 8.

Flex-Lok Joint—See Section 10.

Grooved Joint—See Section 2.

Shouldered Joint—See Section 2.

*To determine the number of joints to be restrained in a given situation, see "Thrust Restraint Design for Ductile Iron Pipe" published by the Ductile Iron Pipe Research Association.



AMERICAN Amarillo Fast-Grip® Gasket

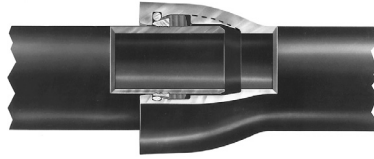

AMERICAN has been in the business of bright ideas for over 110 years. The bright yellow Amarillo Fast-Grip® gasket is just the latest example of a water works innovation that benefits our customers and the public. Designed to the same specifications as the previous generation of Fast-Grips, the Amarillo model gives you added confidence that you've selected the proper gasket for the Fastite bell, that the gasket seated properly during installation and that it's an AMERICAN product — made in America, The Right Way.

The restraint provided by the patented* AMERICAN Amarillo Fast-Grip® gasket is due to the development of wedging action between pairs of high-strength stainless steel elements spaced around the gasket. The outer metal element acts as a bearing member for the wedge-shaped inner element which has sharp teeth on its inner surface for gripping the spigot.

Because of the wedging design utilized, the force between the spigot and the socket of the joint is essentially constant at any given pressure thrust regardless of the "tightness" or "looseness" of the joint fit or the joint deflection.

Amarillo Fast-Grip gaskets are suitable for an allowable water working pressure of 350 psi for 4"-18"*** pipe and 250 psi for 20" and 24"*** sizes. The 30" size is suitable for a 150 psi water working pressure. The joint has a maximum allowable deflection of 5° in the 4"-12", 4° in the 14", 3° in the 16"-24", and 2 1/2° in the 30" size.

Proof-of-design tests have confirmed that the joints are capable of restraining deadend thrust of two or more times the rated working pressure, as applicable. These tests were accomplished with the joints in both straight alignment and at the maximum rated deflection.

The Amarillo Fast-Grip gasket has the same basic shape as AMERICAN's Fastite® gasket, so it can be used in any 4"-30" standard Fastite pipe or fitting socket. The gasket rubber is standard SBR which meets all the material requirements of ANSI/AWWA C111/A21.11.

When they are available on the jobsite, AMERICAN's 16"-30" Flex-Ring® fittings may also be used with the Fast-Grip gasket.

The Fast-Grip gasket is Underwriters Laboratories listed and Factory Mutual approved for use in Fastite or Flex-Ring sockets with Fastite plain ends in all sizes 4"-16". The UL listing and FM approvals apply to all pressure classes and special thickness classes of ductile iron pipe.

In addition to the positive restraint achieved, Amarillo Fast-Grip gaskets offer ergonomically friendly advantages compared to other restrained joints for fittings and pipe requiring bolts, lugs, segments, wrenches, etc. Joints can easily be assembled with current tools and methods used for many years in the assembly of standard Fastite joints. Assembly and disassembly instructions follow.

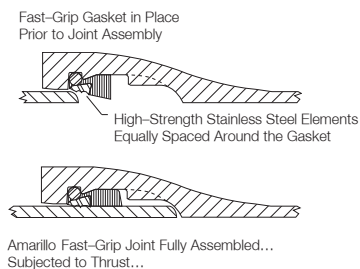

* U.S. Patent No. 5,067,751.

** Because the pressure rating of the joint cannot exceed that of the pipe, the 350 psi rating for 14"-18" sizes and the 250 psi rating for 24" size are limited by the pressure class of pipe with which they are used. For example, an 18" Fast-Grip gasket used with Pressure Class 250 pipe would carry a rating of 250 psi instead of 350 psi. Contact AMERICAN for higher working pressure applications.



AMERICAN Amarillo Fast-Grip® Gasket

Assembly Instructions

Assembling pipe and fitting joints using Amarillo Fast-Grip gaskets is simple. It is very similar to the assembly of Fastite joints shown in Section 2. Amarillo Fast-Grip gaskets may be used in lieu of standard Fastite gaskets in the bells of Fastite and Flex-Ring joint pipe and fittings where easy, field-adaptable restraint is desired.

1. Cleaning of Socket and Spigot

Clean the socket and plain end thoroughly, removing any mud, sand, gravel, ice, frozen material, or other matter that could prevent a proper joint seal. Material in the gasket grooves may cause the gasket to protrude into the path of the entering spigot. Therefore, **it is important that all joint recesses be kept clean during insertion of the gasket and assembly of the joint to prevent gasket dislodgment and/or subsequent leakage.**



2. Placement of Gasket

Wipe the gasket clean. After flexing one or more "loops" in the gasket, insert the gasket in the gasket recess of the socket with the large sealing end of the gasket toward the rear of the socket. The center of the gasket loops should be positioned between tooth locations. Press the gasket into the mating socket recesses, so the metal-carrying retainer end of the gasket is seated completely and uniformly in the socket groove. Take care that no gasket loops or bulges protrude into the path of the entering pipe spigot. In extremely cold weather conditions, gaskets should be warmed before installing. (One way to keep gaskets warm is to keep them in a truck or heated vehicle cab until they are ready to be used.)



Incorrect

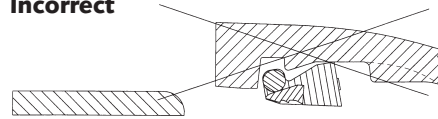

Incorrect

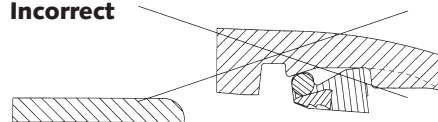

Incorrect

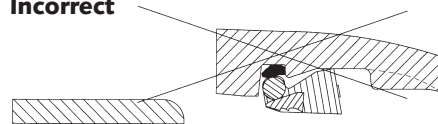

Correct

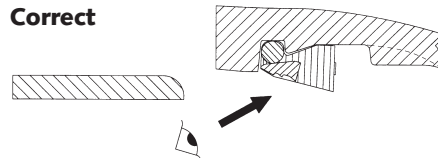



AMERICAN Amarillo Fast-Grip® Gasket

Assembly Instructions—Continued

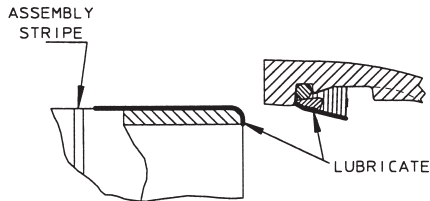

3. Lubrication of the Joint

With a clean brush, apply a liberal amount of regular Fastite lubricant completely **over the end of the pipe, the spigot radius, and the outer surface of the pipe up to the assembly stripe.** Also apply lubricant completely over the exposed inner surface of the gasket. AMERICAN supplies an extra 10% of lubricant to be used with the Amarillo Fast-Grip joints to ensure ease of assembly. **Use only lubricant provided by AMERICAN.** For underwater conditions, special AMERICAN underwater lubricant is recommended and is available upon request.

4. Initial Placement of Bevel End Into Socket

The spigot end of the pipe should be in reasonably straight alignment before it is placed into the socket. Center the spigot in the gasket so it makes firm and even contact with the inner surface of the gasket. Do not place pipe spigot in socket while in a substantially deflected position.



5. Complete Assembly of Plain End Into Socket

For 4" -18" sizes, simply push the bevel end into the bell until it contacts the rear of the socket. Desired joint deflection may then be set.



If the joint is to be deflected less than 2 1/4° for 20", 1 3/4° for 24", and 1° for 30", simply push the pipe spigot until it contacts the back of the socket and deflect. If the joint is to be deflected greater than these amounts, push the pipe spigot into the bell (while in straight alignment) only until the leading edge of the factory-applied yellow assembly stripe is even with the face of the bell. The desired deflection up to the maximum may then be set.

Abnormal joint assembly loads or behavior, such as unexplained exposure of the assembly stripe outside the bell, may indicate improper cleaning, gasket insertion, spigot placement, or lubrication. In any joint assembly, **a thin feeler gauge passed between the bell and spigot all around the assembled joint can be used to confirm correct gasket placement. (See figure below.)** Any joint with apparent problems should be disassembled and corrected before filling and testing the pipeline. (See Disassembly Instructions.)

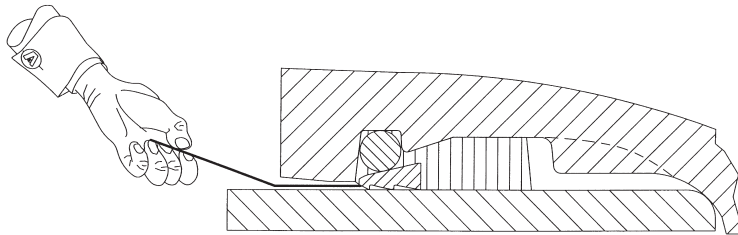



AMERICAN Amarillo Fast-Grip® Gasket

Assembly Instructions—Continued

Field-Cut Pipe

When pipe is cut in the field, the cut end must be properly prepared prior to assembly. In 16" and larger sizes, the ordering and use of a few select pipes that have been "gauged full length" at the factory should be considered when field cuts are anticipated.

Using a portable grinder or other suitable device, place an approximately 3/8"- to 5/8"-long smooth assembly chamfer or bevel on the outside end of the pipe. This bevel should make an angle of 30-40° with the axis of the pipe. Care should be taken to ensure that all corners are rounded and no sharp edges remain that might damage or dislodge the gasket.

If deflection greater than 2 1/4°, 1 3/4°, and 1° is required for 20", 24", and 30" field-cut

pipe, respectively, place an assembly mark on the pipe, respectively, as shown. The spigot should be inserted into the bell during assembly only until the mark becomes even with the bell face. Spigot insertion to the field-applied assembly mark will result in a space between the spigot and the back of the socket.

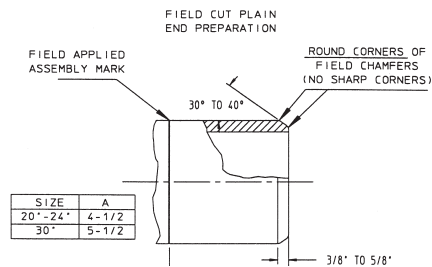

Allowable Joint Deflection for 4"-30" Fastitex Ductile Iron Pipe with Amarillo Fast-Grip Gaskets

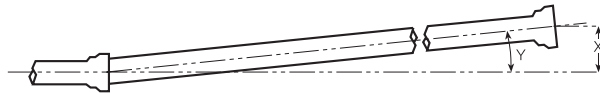

| Size In. | Nominal Laying Length ft. | Maximum Recommended Deflection | |
|----------|---------------------------|--------------------------------|--------------------|
| | | X Offset per 20' Length (in.) | Y Deflection Angle |
| 4 | 20 | 21 | 5° |
| 6 | 20 | 21 | 5° |
| 8 | 20 | 21 | 5° |
| 10 | 20 | 21 | 5° |
| 12 | 20 | 21 | 5° |
| 14 | 20 | 17 | 4° |
| 16 | 20 | 12 | 3° |
| 18 | 20 | 12 | 3° |
| 20 | 20 | 12 | 3° |
| 24 | 20 | 12 | 3° |
| 30 | 20 | 10 | 2 1/2° |

† Allowable deflection for Flex-Ring sockets with Amarillo Fast-Grip gaskets is the same as above for Fastite.



AMERICAN Amarillo Fast-Grip® Gasket

Assembly Instructions—Continued

Disassembly Instructions

Amarillo Fast-Grip gasket joints may normally be disassembled if required. Disassembly kits, consisting of a steel shim holder and special high-strength steel disassembly shims, are required for this operation and are available from AMERICAN. For easier disassembly of a joint that has been subjected to separating thrust or movement, first push the spigot back into the rear of the socket to “unwedge” the teeth.



Using gloves to protect hands from sharp edges, insert a shim fully into the groove in the shim holder.

Starting at the bottom of the joint, carefully drive the disassembly shim past the gasket between the outside of the spigot and the gasket by striking the holder with a hammer. Remove the holder from the shim, and progressively place other shims in this manner all around the joint.

Shims should be in contact with one another to ensure all teeth are disengaged from the spigot. Overlapping of some shims may be required to dislodge all teeth. After all shims are in place, pull or jack the spigot out of the socket.



Very tight joints may have to be separated by cutting pipe. The reuse of Fast-Grip gaskets after disassembly is not advised.

Joint Extension After Installation

The Amarillo Fast-Grip gasket locking mechanism is activated by relative movement

between the spigot and socket. The joint thus allows for movement, joint take-up, and substantial flexibility after installation. Joints may be extended after assembly to minimize joint take-up in test or service and for further assurance of correct joint locking. This may be accomplished by pulling or jacking the spigot away from the socket until firm resistance is encountered. This will not prevent proper joint deflection. In vertical applications such as exposed risers, standard (weld bead) Flex-Ring joints that also should be effectively extended and braced in original installation are recommended instead of Fast-Grip gaskets.

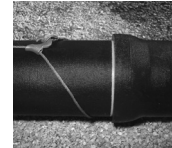

In most underground installations, including most restrained bend locations, joint take-up is advantageous in that increased thrust-resisting soil forces are generated. Also, expansion and contraction due to temperature variations may be accommodated without excessive stress in the pipe members. The amount of joint take-up or line movement in buried restrained pipelines is substantially limited by the surrounding soil. Therefore, system security and safety is maximized by filling and testing restrained sections of pipelines after backfilling.

In any application where axial movement may be undesirable, such as some exposed piping applications, or certain connections of restrained pipe sections at angles to rigid piping, special provisions, including effective joint extension, may be necessary to control unacceptable pipeline movement. Depending on job conditions and restrained pipe length, cumulative joint take-up can be substantial, particularly in exposed or unburied piping applications.



AMERICAN Fast-Grip® Gasket

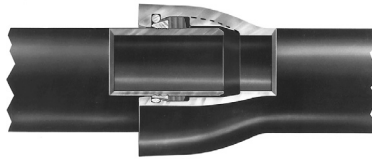

American Fast-Grip gaskets have been proven to be a superior field-adaptable method of restraining 4"-30" ductile iron pipe or fittings for water service.

The restraint provided by the patented* AMERICAN Fast-Grip® gasket is due to the development of wedging action between pairs of high-strength stainless steel elements spaced around the gasket. The outer metal element acts as a bearing member for the wedge-shaped inner element which has sharp teeth on its inner surface for gripping the spigot.

Because of the wedging design utilized, the force between the spigot and the socket of the joint is essentially constant at any given pressure thrust regardless of the "tightness" or "looseness" of the joint fit or the joint deflection.

Fast-Grip gaskets are suitable for an allowable water working pressure of 350 psi for 4"-18" pipe and 250 psi for 20" and 24" sizes. The 30" size is suitable for a 150 psi working pressure. The joint has a maximum allowable deflection of 5° in the 4"-12", 4° in the 14", 3° in the 16"-24", and 2 1/2° in the 30" size.

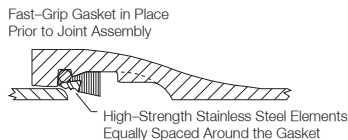

Proof-of-design tests have confirmed that the joints are capable of restraining deadend thrust of two or more times the rated working pressure,

as applicable. These tests were accomplished with the joints in both straight alignment and at the maximum rated deflection.

The Fast-Grip gasket has the same basic shape as AMERICAN's Fastite® gasket, so it can be used in any 4"-30" standard Fastite pipe or fitting socket. The gasket rubber is standard SBR*** which meets all the material requirements of ANSI/AWWA C111/A21.11.

Fastite**** fittings per ANSI/AWWA C110/A21.10 or C153/A21.53 are available in 18"-30" sizes. When they are available on the jobsite, AMERICAN's 16"-30" Flex-Ring® fittings may also be used with the Fast-Grip gasket.

The Fast-Grip gasket is Underwriters Laboratories listed and Factory Mutual approved for use in Fastite or Flex-Ring sockets with Fastite plain ends in all sizes 4"-16". The UL listing and FM approvals apply to all pressure classes and special thickness classes of ductile iron pipe.

In addition to the positive restraint achieved, Fast-Grip gaskets offer ergonomically friendly advantages compared to other restrained joints for fittings and pipe requiring bolts, lugs, segments, wrenches, etc. Joints can easily be assembled with current tools and methods used for many years in the assembly of standard Fastite joints. Assembly and disassembly instructions follow.



* U.S. Patent No. 5,067,751.

** Because the pressure rating of the joint cannot exceed that of the pipe, the 350 psi rating for 14"-18" sizes and the 250 psi rating for 24" size are limited by the pressure class of pipe with which they are used. For example, an 18" Fast-Grip gasket used with Pressure Class 250 pipe would carry a rating of 250 psi instead of 350 psi. Contact AMERICAN for higher working pressure applications.

*** Contact AMERICAN if other types of rubber are required.

**** Contact AMERICAN for the availability of fitting plain ends.



AMERICAN Fast-Grip® Gasket

Assembly Instructions

Assembling pipe and fitting joints using Fast-Grip gaskets is simple. It is very similar to the assembly of Fastite joints shown in Section 2. Fast-Grip gaskets may be used in lieu of standard Fastite gaskets in the bells of Fastite and Flex-Ring joint pipe and fittings where easy, field-adaptable restraint is desired.



1. Cleaning of Socket and Spigot

Clean the socket and plain end thoroughly, removing any mud, sand, gravel, ice, frozen material, or other matter that could prevent a proper joint seal. Material in the gasket grooves may cause the gasket to protrude into the path of the entering spigot. Therefore, **it is important that all joint recesses be kept clean during insertion of the gasket and assembly of the joint to prevent gasket dislodgment and/or subsequent leakage.**

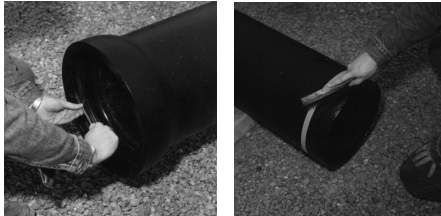

2. Placement of Gasket

Wipe the gasket clean. After flexing one or more "loops" in the gasket, insert the gasket in the gasket recess of the socket with the large sealing end of the gasket toward the rear of the socket. The center of the gasket loops should be positioned between tooth locations. Press the gasket into the mating socket recesses, so the metal-carrying retainer end of the gasket is seated completely and uniformly in the socket groove. Take care that no gasket loops or bulges protrude into the path of the entering pipe spigot. In extremely cold weather conditions,



gaskets should be warmed before installing. (One way to keep gaskets warm is to keep them in a truck or heated vehicle cab until they are ready to be used.)

Incorrect

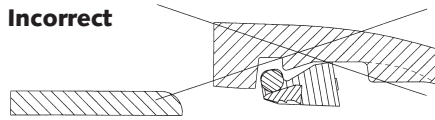

Incorrect

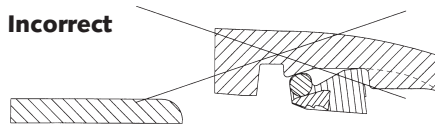

Incorrect

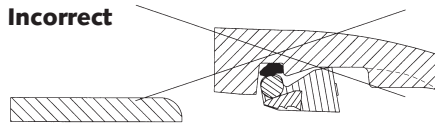

Correct

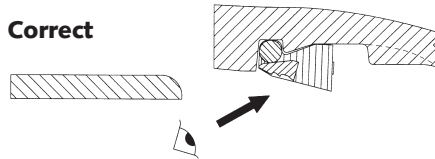



AMERICAN Fast-Grip® Gasket

Assembly Instructions—Continued

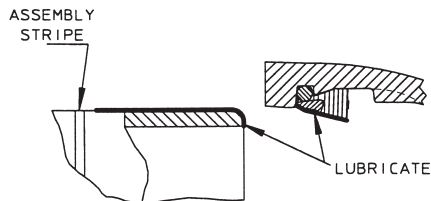

3. Lubrication of the Joint

With a clean brush, apply a liberal amount of regular Fastite lubricant completely **over the end of the pipe, the spigot radius, and the outer surface of the pipe up to the assembly stripe.** Also apply lubricant completely over the exposed inner surface of the gasket. AMERICAN supplies an extra 10% of lubricant to be used with the Fast-Grip joints to ensure ease of assembly. **Use only lubricant provided by AMERICAN.** For underwater conditions, special AMERICAN underwater lubricant is recommended and is available upon request.

4. Initial Placement of Bevel End Into Socket

The spigot end of the pipe should be in reasonably straight alignment before it is placed into the socket. Center the spigot in the gasket so it makes firm and even contact with the inner surface of the gasket. Do not place pipe spigot in socket while in a substantially deflected position.



5. Complete Assembly of Plain End Into Socket

For 4"-18" sizes, simply push the bevel end into the bell until it contacts the rear of the socket. Desired joint deflection may then be set.



If the joint is to be deflected less than 2 1/4° for 20", 1 3/4° for 24", and 1° for 30", simply push the pipe spigot until it contacts the back of the socket and deflect. If the joint is to be deflected greater than these amounts, push the pipe spigot into the bell (while in straight alignment) only until the leading edge of the factory-applied yellow assembly stripe is even with the face of the bell. The desired deflection up to the maximum may then be set.

Abnormal joint assembly loads or behavior, such as unexplained exposure of the assembly stripe outside the bell, may indicate improper cleaning, gasket insertion, spigot placement, or lubrication. In any joint assembly, **a thin feeler gauge passed between the bell and spigot all around the assembled joint can be used to confirm correct gasket placement. (See figure below.)** Any joint with apparent problems should be disassembled and corrected before filling and testing the pipeline. (See Disassembly Instructions.)

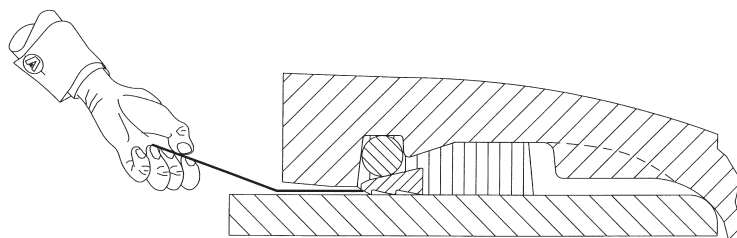



AMERICAN Fast-Grip® Gasket

Assembly Instructions—Continued

Field-Cut Pipe

When pipe is cut in the field, the cut end must be properly prepared prior to assembly. In 16" and larger sizes, the ordering and use of a few select pipes that have been "gauged full length" at the factory should be considered when field cuts are anticipated.

Using a portable grinder or other suitable device, place an approximately 3/8"- to 5/8"- long smooth assembly chamfer or bevel on the outside end of the pipe. This bevel should make an angle of 30-40° with the axis of the pipe. **Care should be taken to ensure that all corners are rounded and no sharp edges remain that might damage or dislodge the gasket.**

If deflection greater than 2 1/4", 1 3/4", and 1" is required for 20", 24", and 30" field-cut

pipe, respectively, place an assembly mark on the spigot as shown. The spigot should be inserted into the bell during assembly only until the mark becomes even with the bell face. Spigot insertion to the field-applied assembly mark will result in a space between the spigot and the back of the socket.

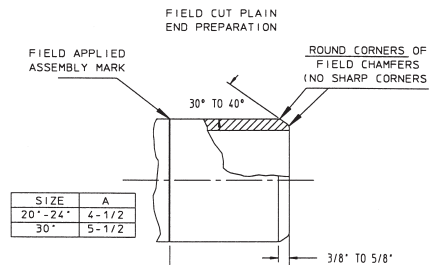

Allowable Joint Deflection for 4"-30" Fastite† Ductile Iron Pipe with Fast-Grip Gaskets

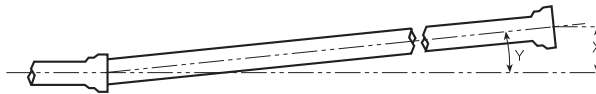

| Size In. | Nominal Laying Length ft. | Maximum Recommended Deflection | |
|----------|---------------------------|--------------------------------|--------------------|
| | | X Offset per 20' Length (in.) | Y Deflection Angle |
| 4 | 18 | 19 | 5° |
| 6 | 20 | 21 | 5° |
| 8 | 20 | 21 | 5° |
| 10 | 20 | 21 | 5° |
| 12 | 20 | 21 | 5° |
| 14 | 20 | 17 | 4° |
| 16 | 20 | 12 | 3° |
| 18 | 20 | 12 | 3° |
| 20* | 20 | 12 | 3° |
| 24* | 20 | 12 | 3° |
| 30* | 20 | 10 | 2 1/2° |

† Allowable deflection for Flex-Ring sockets with Fast-Grip gaskets is the same as above for Fastite.

* Allowable deflection for 20", 24", and 30" Fastite AWWA C110 fitting joints with Fast-Grip gaskets 2 1/4", 1 3/4", and 1", respectively.

Assembly of Fittings

Pipe and fittings joints can be easily assembled with current tools and methods used for many years in the assembly of Fastite joints. A line of "assembly yokes" and associated rigging for 4"-16" sizes are available that allow easy assembly

of fitting configurations, such as 90° bends, etc. Field rigging for larger-sized fitting assemblies can normally be accomplished with common grab chains, wire rope choker cables, etc. as per photographs in Section 4.



AMERICAN Fast-Grip® Gasket

Assembly Instructions—Continued

*Fast-Grip gasketed joints requiring a particular orientation (such as with bends) should be assembled in the intended service position. In some instances, this may be accomplished more easily by first assembling the bend on a pipe above the trench. The jointed bend and pipe may then be lowered (orienting as required) and assembled into place. **Relative rotation of joint members to one another after assembly is not recommended as it could cause damage or leakage.***

See Push-On Fittings Assembly Instructions in Section 4.

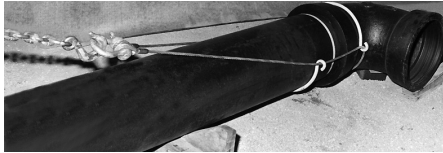

Disassembly Instructions

Fast-Grip gasket joints may normally be disassembled if required. Disassembly kits, consisting of a steel shim holder and special high-strength steel disassembly shims, are required for this operation and are available from AMERICAN. For easier disassembly of a joint that has been subjected to separating thrust or movement, first push the spigot back into the rear of the socket to “unwedge” the teeth.

Using gloves to protect hands from sharp edges, insert a shim fully into the groove in the shim holder.

Starting at the bottom of the joint, carefully drive the disassembly shim past the gasket between the outside of the spigot and the gasket by striking the holder with a hammer. Remove the holder from the shim, and progressively place other shims in this manner all around the joint.

Shims should be in contact with one another to ensure all teeth are disengaged from the spigot. Overlapping of some shims may be required to dislodge all teeth. After all shims are in place, pull or jack the spigot out of the socket.



Very tight joints may have to be separated by cutting pipe. The reuse of Fast-Grip gaskets after disassembly is not advised.

Joint Extension After Installation

The Fast-Grip gasket locking mechanism is activated by relative movement between the spigot and socket. The joint thus allows for movement, joint take-up, and substantial flexibility after installation. Joints may be extended after assembly to minimize joint take-up in test or service and for further assurance of correct joint locking.

This may be accomplished by pulling or jacking the spigot away from the socket until firm resistance is encountered. This will not prevent proper joint deflection. In vertical applications such as exposed risers, standard (weld bead) Flex-Ring joints that also should be effectively extended and braced in original installation are recommended instead of Fast-Grip gaskets.

In most underground installations, including most restrained bend locations, joint take-up is advantageous in that increased thrust-resisting soil forces are generated. Also, expansion and contraction due to temperature variations may be accommodated without excessive stress in the pipe members. The amount of joint take-up or line movement in buried restrained pipelines is substantially limited by the surrounding soil. Therefore, system security and safety is maximized by filling and testing restrained sections of pipelines after backfilling.

In any application where axial movement may be undesirable, such as some exposed piping applications, or certain connections of restrained pipe sections at angles to rigid piping, special provisions, including effective joint extension, may be necessary to control unacceptable pipeline movement. Depending on job conditions and restrained pipe length, cumulative joint take-up can be substantial, particularly in exposed or unburied piping applications.





AMERICAN Ductile Iron Flex-Ring® Joint Pipe

Centrifugally Cast for Water, Sewage, or Other Liquids

4"-12" Flex-Ring® Joint

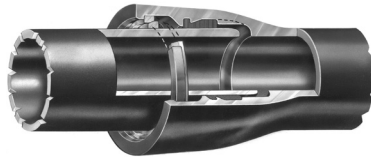

AMERICAN Flex-Ring® Restrained Joint Ductile Iron pipe, utilizing the sealing features of the time-proven Fastite® Joint and a boltless restrained connection, provides flexible, easily assembled, positive restraint against endwise separation due to thrust.

The patented Flex-Ring Joint is designed for a working pressure equal to that of the pipe or up to 350 psi in sizes 4"-24" and up to 250 psi in sizes 30" through 48". The joint has been thoroughly factory tested to withstand dead-end thrust resulting from more than twice those working pressures.

Flex-Ring® joint pipe with its positive, flexible joint restraint may also be used in trenchless applications such as **horizontal directional drilling** and pipe bursting. With spigot ahead, the low-profile Flex-Ring® bell assembles quickly and offers a smooth transition during pipe pull-back. AMERICAN offers a Flex-Ring® pulling bell assembly specifically designed for this installation method.



Pulling Bell Assembly

14"-54" Flex-Ring® Joint

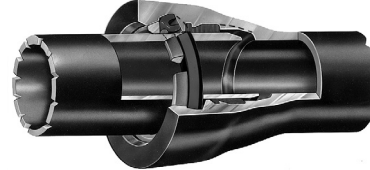

For 4"-12" sizes, a beveled ductile iron, welded-on retainer ring and a yellow painted ductile iron split flex-ring, assembled behind the retainer ring, provide the means of restraint. After the plain end of the pipe is assembled into the Flex-Ring bell, the split flex-ring is inserted and springs into the socket locking groove. The flex-ring is securely positioned behind the welded-on retainer ring and in the socket locking groove on the inside of the pipe bell. This provides the flexible restraint.

For 14"-54" sizes, a shop-applied weld bead and a rubber-backed ring, containing yellow painted ductile iron segments, provide the means of restraint. As the plain end of the pipe is fully assembled into the bell, the ductile iron segments automatically close on the pipe behind the weld bead. The enclosure of the segments between the weld bead, spigot, and the sloped inner lip of the bell provides the flexible restraint.

The Flex-Ring Joint can be safely deflected after assembly to the limits shown in Table Nos. 9-1 and 9-2. This liberal deflection facilitates installation, decreases the number of necessary fittings, and accommodates settlement.

The Flex-Ring Joint is Underwriters Laboratories listed and Factory Mutual approved in sizes 4"-12". This UL listing and FM approval applies to all pressure classes and special thickness classes of ductile iron pipe. The only joint components needed to assemble the Flex-Ring Joint are a gasket and a single ring.



AMERICAN Ductile Iron Flex-Ring® Joint Pipe

Centrifugally Cast for Water, Sewage, or Other Liquids

No loose lugs, heavy wedges, rubber tubes, etc. are necessary. Also, there is no need to orient bells to ensure proper installation, though for convenience, most installers orient the split locking ring ends in 4"-12" sizes away from the very bottom of the joints. Just follow the simple instructions shown on the following pages, and positive restraint is ensured.

Flex-Rings, Flex-Ring segments, and retainer rings are manufactured of ductile iron compatible with pipe. Welds and weld beads (if used) are nickel-iron, proven desirably cathodic to the ductile iron pipe, and welding is performed using welders qualified to produce high-quality, dependable welds.

Fittings for use with 16"- 48" Flex-Ring pipe are ductile iron and meet or exceed the applicable performance and manufacturing requirements of ANSI /AWWA C110/A21.10 or ANSI/AWWA C153/A21.53. These are rated

for the same working pressures shown for like fittings in C110 and C153. Fittings in these sizes are also available in both bell-bell and bell-Flex-Ring spigot configurations for installation versatility and economy.

AMERICAN Flex-Ring® pipe and fittings are normally furnished with standard asphaltic coating outside and cement lined in accordance with ANSI/AWWA C104/A21.4. Special coatings and linings can be furnished when specified.

Field closures or other restraint can normally be securely made by using AMERICAN's Fast-Grip® gasket, which is available in 4"-30" sizes. (See page 9-2 for details of the Fast-Grip gasket.)The Fast-Grip® gasket restraint closure is UL listed and FM approved for use in Flex-Ring and Fastite bells in 4"-16" sizes. Field closures or other restraint in 14"-36" sizes can also be made in Flex-Ring bells only by using AMERICAN's Field Flex-Ring®. (See page 9-16.)



AMERICAN DUCTILE IRON PIPE

AMERICAN Ductile Iron Flex-Ring® Joint Pipe
Standard Dimensions and Pressure Ratings

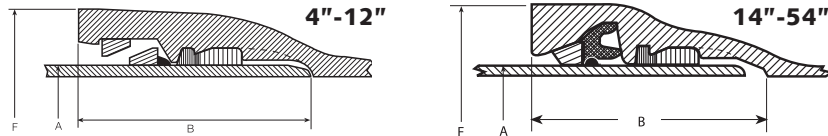

Table No. 9-1 **4"-12"**

| Size in. | Working Pressure* psi | Nominal Laying Length** ft. | A O.D. in. | B Socket Depth in. | F Bell O.D.† in. | Allowable Pulling Load lb.†† | Allowable Deflection degree | Offset per 20' Length in. | Radius of Curve^ ft. | Empty Pipe Buoyancy in Water (lb/ft)^^^ |
|----------|-----------------------|-----------------------------|------------|--------------------|------------------|------------------------------|-----------------------------|---------------------------|----------------------|---|
| 4 | 350 | 20 | 4.80 | 5.62 | 7.06 | 10,000 | 5 | 21 | 230 | -5 |
| 6 | 350 | 20 | 6.90 | 5.62 | 9.19 | 20,000 | 5 | 21 | 230 | -2 |
| 8 | 350 | 20 | 9.05 | 5.74 | 11.33 | 30,000 | 5 | 21 | 230 | 3 |
| 10 | 350 | 20 | 11.10 | 6.72 | 13.56 | 45,000 | 5 | 21 | 230 | 11 |
| 12 | 350 | 20 | 13.20 | 6.72 | 15.74 | 60,000 | 5 | 21 | 230 | 19 |

* Working pressure is the maximum pressure rating of the joint and is based on its capability to resist thrust due to internal pressure. If higher working pressure is required, check AMERICAN.

** Laying length is nominal 20'. Where exact lengths are required, contact AMERICAN. Minimum laying lengths for Flex-Ring & Flex-Ring End pipe is 1'-0" and for Flex-Ring End & Flex-Ring End pipe is 2'-0".

† Dimensions subject to change at our option. Check AMERICAN if smaller or exact dimensions are required.

†† Intended for Horizontal Directional Drilling (HDD) applications, so these pulling loads are for a fully deflected position. Flex-Ring pipe may be available for greater pulling loads than indicated in the tabulated values. **Contact AMERICAN when higher pulling loads are required.**

^ Approximate radius of curve produced by a succession of 20' lengths of pipe fully deflected.

^^ Based on weight of empty (full of air) Pressure Class 350 Flex-Ring pipe with standard cement lining immersed in water. Positive numbers indicate such pipe will float.

Table No. 9-2 **14"-54"**

| Size in. | Working Pressure* psi | Nominal Laying Length** ft. | A O.D. in. | B Socket Depth in. | F Bell O.D.† in. | Allowable Pulling Load lb.†† | Allowable Deflection degree | Offset per 20' Length in. | Radius of Curve^ ft. | Empty Pipe Buoyancy in Water (lb/ft)^^^ |
|----------|-----------------------|-----------------------------|------------|--------------------|------------------|------------------------------|-----------------------------|---------------------------|----------------------|---|
| 14 | 350 | 20 | 15.30 | 7.38 | 19.31 | 75,000 | 4 | 17 | 285 | 27 |
| 16 | 350 | 20 | 17.40 | 7.38 | 21.08 | 95,000 | 3 3/4 | 16 | 305 | 38 |
| 18 | 350 | 20 | 19.50 | 8.20 | 23.70 | 120,000 | 3 3/4 | 16 | 305 | 52 |
| 20 | 350 | 20 | 21.60 | 8.20 | 25.37 | 150,000 | 3 1/2 | 15 | 327 | 69 |
| 24 | 350 | 20 | 25.80 | 8.96 | 29.88 | 210,000 | 3 | 12 | 380 | 104 |
| 30 | 250 | 20 | 32.00 | 9.63 | 36.34 | 220,000 | 2 1/2 | 10 | 458 | 175 |
| 36 | 250 | 20 | 38.30 | 9.63 | 43.10 | 310,000 | 2 | 8 | 570 | 266 |
| 42 | 250 | 20 | 44.50 | 10.84 | 49.92 | 390,000 | 2 | 8 | 570 | 359 |
| 48 | 250 | 20 | 50.80 | 12.37 | 56.36 | 500,000 | 2 | 8 | 570 | 484 |
| 54 | 250 | 20 | 57.56 | 12.74 | 63.90 | 650,000 | 1 1/2 | 8 | 570 | 632 |

* Working pressure is the maximum pressure rating of the joint and is based on its capability to resist thrust due to internal pressure. If higher working pressure is required, check AMERICAN. Pressure rating of the joint is limited by the pressure rating of the parent pipe.

** Laying length is nominal 20'. Where exact lengths are required, contact AMERICAN. See below for minimum laying lengths for 14"-48" Flex-Ring.

† Dimensions subject to change at our option. Check AMERICAN if smaller or exact dimensions are required.

†† Intended for Horizontal Directional Drilling (HDD) applications, so these pulling loads are for a fully deflected position. The tabulated values are based on Pressure Class 350 pipe thickness. **Contact AMERICAN when it may be desirable to use lesser pressure class pipe or when higher pulling loads are required.** Flex-Ring pipe may be available for greater pulling loads than indicated in the tabulated values.

^ Approximate radius of curve produced by a succession of 20' lengths of pipe fully deflected.

^^ Based on weight of empty (full of air) Pressure Class 350 Flex-Ring pipe with standard cement lining immersed in water. Positive numbers indicate such pipe will float.

Minimum Laying Lengths

| Size in. | Flex-Ring & Flex-Ring End | Flex-Ring End & Flex-Ring End |
|----------|---------------------------|-------------------------------|
| 14 | 1'-6" | 2'-0" |
| 16 | 1'-6" | 2'-0" |
| 18 | 1'-6" | 2'-0" |
| 20 | 1'-6" | 2'-0" |
| 24 | 2'-0" | 2'-6" |
| 30 | 2'-0" | 2'-6" |
| 36 | 2'-0" | 2'-6" |
| 42 | 2'-0" | 3'-0" |
| 48 | 2'-6" | 3'-0" |
| 54 | 3'-0" | 3'-6" |



AMERICAN Ductile Iron Flex-Ring® Joint Pipe
Assembly Instructions
4"-12"

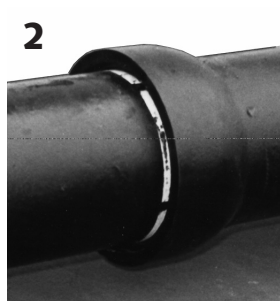

Prior to joint assembly, remove the packing material holding the split flex-ring onto the pipe. (See "Field Assembly of Flex-Ring" if split flex-ring is shipped separately.) Thoroughly clean the socket locking groove as well as the Fastite gasket recess and pipe plain end. In accordance with standard Fastite joint assembly instructions, insert the gasket and lubricate the pipe plain end, bevel, and inside surface of the gasket. With the pipe in essentially straight alignment, assemble the plain end into the Flex-Ring socket until the spigot stripe disappears into the bell. The orientation of the spigot stripe relative to the bell face is an indication of pipe alignment.

1. Tap the flex-ring into the socket beginning with one end of the flex-ring and progressing around the joint as shown in Photo 1. This

operation is made easier by holding one end of the flex-ring inside the bell as the remainder of the ring is caulked into the socket. Correct seating is generally ensured by a snapping noise as the flex-ring springs into position. This should be accompanied by visual or tactile inspection (the flex-ring is painted yellow to aid in this inspection). (Note: When a visual inspection to determine the flex-ring position is not practical, such as in an underwater installation, a feeler gauge can be used to ensure the correct positioning of the flex-ring in the socket locking groove. It may be necessary to move the entering pipe slightly to improve alignment if the ring does not readily spring into the socket locking groove.)

2. The completed joint.



This bridge crossing illustrates design/construction advantages, including the deflection capabilities of AMERICAN Flex-Ring Joint Pipe.



AMERICAN Ductile Iron Flex-Ring® Joint Pipe Assembly Instructions 4"-12"



FIELD ASSEMBLY OF FLEX-RING

If the split flex-ring is shipped separately, assemble it onto the pipe spigot by spreading the Flex-Ring ends as shown above. Be sure that the flex-ring is oriented so that the small end is toward the pipe plain end.



DISASSEMBLY OF 4"-12" FLEX-RING

If disassembly of the joint is required, it may be accomplished by inserting pins or nails into the drilled holes furnished in the flex-ring ends and compressing the flex-ring firmly onto the pipe as shown above. If desired, steel pins can be field welded onto the ends of common adjustable pliers, if such a disassembly tool is more desirable to the user. If axial movement or joint extension has occurred in the joint prior to disassembly, it may be necessary to move the spigot completely to the rear of the socket in straight alignment to allow the Flex-Ring to be compressed for removal.

THE FOLLOWING INFORMATION PERTAINS TO 4"-54" JOINTS:

NOTE: The AMERICAN Flex-Ring Joint allows for joint take-up and flexibility after installation. In most underground installations, including most restrained bend locations, this feature is advantageous in that increased thrust-resisting soil forces are generated. Also, expansion and contraction due to temperature variations may be accommodated without excessive stress in the pipe members.

In any application where axial or lateral movement may be undesirable, such as certain bridge crossings, certain exposed or unburied piping applications, or certain connections of restrained pipe sections to rigid piping, special provisions, including effective joint extension, may be necessary to control unacceptable pipe-

line movement. (See also Section 7, Pipe-On-Supports, etc.)

Depending on job conditions and restrained pipe length, cumulative joint take-up can be substantial, particularly in exposed or unburied piping applications. In this regard, joints may be extended after assembly to minimize further joint take-up in test or service. This will not prevent proper joint deflection.

The amount of joint take-up or line movement in buried restrained pipelines is substantially limited by the surrounding soil. Therefore, system security and safety is maximized by filling and testing restrained sections of pipelines after back-filling as recommended by ANSI/AWWA C600, [Installation of Ductile Iron Water Mains and Their Appurtenances](#) and AWWA M41.



AMERICAN Ductile Iron Flex-Ring® Joint Pipe Assembly Instructions 14"-54"

1) Cleaning and Fastite gasket insertion

Thoroughly clean the socket restraining groove (nearest the bell end), the Fastite gasket recess, and the pipe plain end, removing dirt, sand, ice, mud, or any other material which could prevent the proper placement of the Fastite gasket and flex-ring. As in normal Fastite joint assembly, insert the gasket into the gasket socket groove

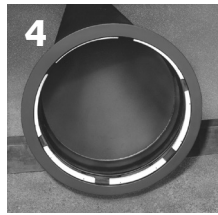
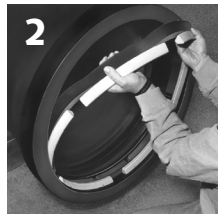

(1). Important: A Fastite gasket must also be used, because the rubber-backed flex-ring does not perform any sealing function. 2) Placement of the flex-ring in socket and joint lubrication

Remove the flex-ring from its container and place it in the socket restraining groove in gasket-like fashion (Photo 2). The yellow restraining segments of the flex-ring must be oriented toward the entering spigot. This may be done by first placing the flex-ring in the socket groove by forming one or more inward or lateral loops in the rubber backed ring (Photo 3). Work all inward or lateral loops fully outward and planar such that each metal segment fits reasonably flush against the

wedging surface of the socket, and no rubber bulges or twists remain (Photo 4).

Lubricate the inside surface of the gasket and the first four inches of the spigot including the beveled nose end of the pipe. Do not allow the lubricated spigot end of the pipe to contact the ground prior to insertion.

3) Initial placement of Flex-Ring spigot end into socket

With the spigot in reasonably straight alignment and centered within the flex-ring (Photo 5),

insert the spigot until it contacts the back of the socket per normal Fastite joint assembly procedure. (See Section 2 for additional detail on Fastite assembly procedures.) When

the weld bead is in proper assembled position fully beyond the yellow Flex-Ring segments, every segment will be trapped firmly between the weld bead, the spigot, and the wedging surface of the socket.

Verify the correct positioning of the yellow Flex-Ring segments by visual inspection (or by "feeler" gauge if installed in conditions of poor visibility).

The segments will normally snap directly into the correct assembled position. However, if any segment should not come down firmly onto the pipe at any location, deflect the pipe slightly in that direction, thereby allowing the segment to seat itself correctly.

After joint assembly, the joint may be extended and then deflected within the range of allowable joint deflection for the size of pipe being assembled.

4) Assembly of fittings

Flex-Ring pipe and fitting joints can generally be assembled with the same tools and methods used for many years with Fastite joints. When using a field-cut pipe to locate a fitting, it may be advantageous to use an uncut flex-ring spigot end (with factory weld bead) and a standard Flex-Ring in the fitting socket rather than using a field-cut plain end and Field Flex-Ring with

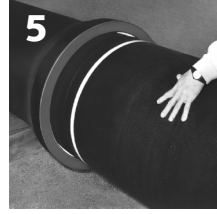



AMERICAN Ductile Iron Flex-Ring® Joint Pipe Assembly Instructions 14"-54"

black-toothed gripping segments. A Field Flex-Ring and cut pipe plain end may then be used in the nearest pipe socket on either side of the fitting. When possible, the use of standard flex-ring with yellow segments and factory spigots with weld beads in the sockets of a fitting may allow easier orientation or rotation of the fitting relative to the pipe after assembly, if this is needed. (See Section 4 for additional detail on the assembly of Fastite fittings.)

5) Joint extension after installation

The 14" - 54" Flex-Ring locking mechanism allows approximately one inch of free axial movement and also provides substantial flexibility after installation. However, the joints may be extended after assembly to minimize this joint takeup in test or service conditions.

In most underground installations (including most restrained bend locations), joint take-up is advantageous in that increased thrust-resisting forces are generated. Also, expansion and contraction due to temperature variations may be accommodated without excessive stress in pipe members. The amount of joint take-up or line movement in buried restrained pipelines is substantially limited by the surrounding soil. There-

fore, system security and safety is maximized by filling and testing restrained sections of pipelines **after** backfilling as recommended by ANSI/AWWA C600, Installation of Ductile Iron Water Mains and Their Appurtenances and AWWA M41.

In any application where axial or lateral movement may be undesirable, such as certain bridge crossings, certain exposed or unburied piping applications, or certain connections of restrained pipe sections to rigid piping, special provisions, including effective joint extension, may be necessary to control unacceptable pipeline movement.

Depending on job conditions and restrained pipe length, cumulative joint take-up can obviously be substantial, particularly in exposed piping applications. Where joint pre-extension is necessary in a piping system, it may be accomplished by pulling or jacking the spigot away from the socket until firm resistance is encountered. This will not limit joint flexibility. See "Restrained Joint Pipe Assembly Extension Procedure" in this section of the Pipe Manual for more information concerning joint extension.



The versatile performance capabilities of AMERICAN Flex-Ring Joint Pipe are perfectly suited for projects containing a variety of conditions such as the hilly, rocky terrain shown in this photo.



AMERICAN Ductile Iron Flex-Ring® Joint Pipe Disassembly Instructions for 14"-54" Flex-Ring Joints

Flex-Ring joints may be disassembled if required using sharp wedges and 3/16"-1/4" thick disassembly shims. Flex-Ring disassembly sets are available from AMERICAN and are suggested for disassembly. These disassembly sets include two sharp steel starter wedges and an appropriate number of "L"-shaped shims. The wedges are used to start the separation of the yellow Flex-Ring joint locking segments outward from the spigot while it is in the bell of an already assembled joint. The "L"-shaped shims are then hammered between the spigot and each locking segment. The thicker shims lift the locking segments entirely away from the spigot when fully inserted, and allow the spigot weld bead to pass under the locking segments generally located as shown in Figs. 1 and 2. Step-by-step instructions follow:

1. First straighten the joint as much as possible and push or pull the spigot back into the bell until it "bottoms out" in the rear of the socket. (Fig. 3)

2. Hammer a starter wedge under a yellow locking segment until an approximately 1/8" gap is seen between the segment and the spigot. (Fig. 4)

3. Hammer a second wedge (if necessary to start the shims) under the other end of the locking segment as in step 2.

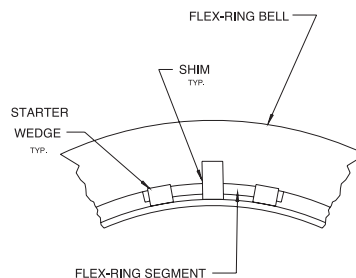

Figure 1
Starter shim and wedge arrangement for 14", 18", and 20" sizes.

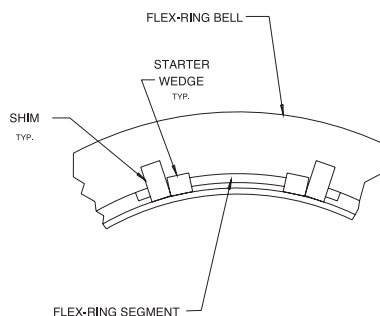

Figure 2
Shim and wedge arrangement for 16", 24", 30", 42", 48", and 54" sizes.

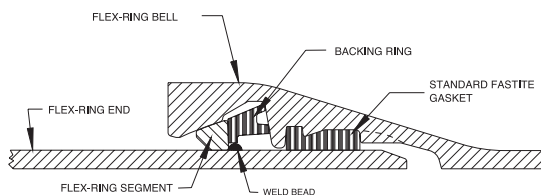

Figure 3

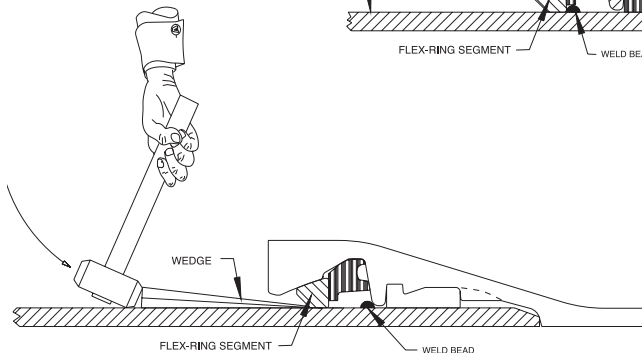

Figure 4

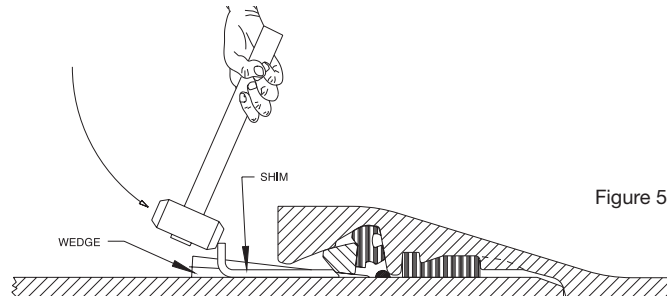

Figure 5

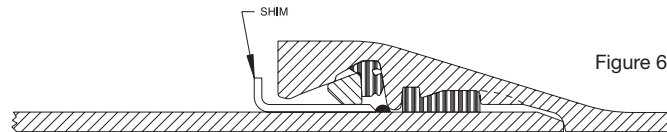

Figure 6

4. With a large hammer (such as a six pounder) vigorously drive one or two “L”-shaped shims under the locking segment until the ends of the shims firmly contact the spigot weld bead. (Fig. 5) Shims and wedges can be safely and firmly held against the pipe as they are hammered using a block of wood or a board. Safety precautions such as the wearing of safety glasses and keeping clear of the hammer during striking should always be taken to avoid injury.

5. Remove the starter wedges from between the locking segment and spigot, leaving the shim(s) in place. (Fig. 6) Note that the wedges are reused for each locking segment.

6. Drive wedges and shims under all locking segments as shown in steps 2-5. (See photo.) Check to be sure that the inner surface of all segments will not interfere with the spigot weld bead during joint separation after inserting shims.

7. Separate the joint. During joint separation, it is generally best to pull the spigot straight out of the socket. Extreme back and forth deflecting motions of the spigot during joint separation can cause shims to fall out of the joint and/or relocking to occur. If the joint does not readily come apart, check to see if one or more of the segments is in locking contact with the spigot weld bead. If so, push or deflect the spigot back in that location and add or replace shims as required.



Disassembly kits accompanied by instructions for use can be furnished by AMERICAN upon request.



AMERICAN Ductile Iron Flex-Ring® Joint Pipe Field Flex-Ring®

4-inch, 6-inch, 8-inch and 12-inch



The AMERICAN Field Flex-Ring is a field adaptable restrained joint utilizing a grooved fabricated end in conjunction with a corrosion-resistant, high-strength, low-alloy (HSLA) steel Field Ring. AMERICAN Field Flex-Ring® Restrained Joint Ductile Iron Pipe, utilizing the sealing features of the time-proven Fastite® Joint and a one-bolt restrained connection, provides flexible, easily assembled and positive restraint against endwise separation due to thrust.

The AMERICAN Field Flex-Ring is an integral part of the AMERICAN Flex-Ring Joint restraint system on 4-, 6-, 8- and 12-inch ductile iron Flex-Ring Pipe and fittings as an easy, one-bolt field adaptable way of restraining field connections, which also does not require a factory or field weldment. Where field cuts are anticipated, the AMERICAN Field Flex-Ring may be used to restrain joints with any suitable ductile iron plain end or cut pipe for water service in lieu of a standard Flex-Ring Joint spigot with a factory welded-on ring.

The AMERICAN Field Flex-Ring is designed to restrain joints using the Flex-Ring sockets with the same allowable working

pressures and deflection capabilities as the standard Flex-Ring Joint. (See Table 9-1.) Field Flex-Rings may be used with a minimum 53 thickness class ductile iron pipe with a maximum working pressure of 350 psi. Restrained joints using the AMERICAN Field Flex-Ring have been thoroughly factory tested to withstand dead end thrust resulting from more than twice the rated working pressure.

For the 4-, 6-, 8- and 12-inch sizes, the restraint is provided by wedging action between the beveled corrosion-resistant, high-strength, low-alloy (HSLA) steel Field Ring and a yellow painted ductile iron split Flex-Ring assembled behind the retainer ring. Once the grooved fabricated end is created and the Field Ring is installed, the Field-Flex Ring spigot end behaves identically to the Flex-Ring spigot end. After the spigot end of the Field Flex-Ring pipe is assembled into the Flex-Ring bell, the split Flex-Ring is inserted and springs into the socket locking groove. The Flex-Ring is securely positioned behind the bolt-on retainer ring and in the socket locking groove on the inside of the pipe bell, providing the flexible restraint.





AMERICAN Ductile Iron Flex-Ring® Joint Pipe Field Flex-Ring® 4-inch, 6-inch, 8-inch and 12-inch Assembly Instructions

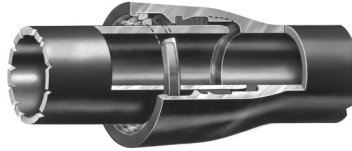

AMERICAN Field FLEX-RING® Spigot Rings are intended for use with AMERICAN Flex-Ring® Ductile Iron Pipe, 4-, 6-, 8- and 12-inch, for thickness classes 53 through 56 per ANSI/AWWA C151/A21.51 having a pressure rating of 350 psi.

Field-Cut Joint

Measure the pipe diameter at the desired cut distance to ensure it meets the ANSI/AWWA C111/A21.11 tolerances. Cutting the pipe can be performed using abrasive wheels, torch or milling cutter. When the cut end is to be assembled in a Flex-Ring® bell, an adequately smooth (without sharp edges) bevel should be ground or filed on the cut edge to prevent damage to or dislodgement of the gasket during assembly (Figure 1). If desired, a thin field assembly line may be drawn in marker or paint, with the line located from the spigot end the same distance as the far edge of factory-applied assembly stripe.

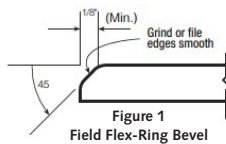

Groove Pipe

Several types of grooving machines are available that operate hydraulically, pneumatically, electrically, or are self-powered by a gasoline engine. The grooving machine will normally cut pipe from 4- to 64-inch diameter. The set-up time for this cutter is usually less than ten minutes; it requires a minimum clearance of 12 inches and has a cutting speed of approximately one minute per inch of pipe diameter. The grooving machine should be installed to provide the cut edge at the designated distance from the spigot end as shown in Table 1. The groove should be cut as a standard AWWA C606 groove as seen in Figure 2.

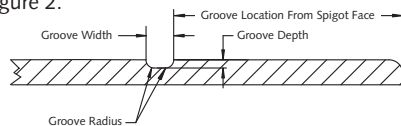

Table No. 9-3

| Field Groove Dimensions | | | | |
|-------------------------|----------------------------------|---------------------------|---------------------------|---------------|
| Size | Groove Location From Spigot Face | Groove Width | Groove Depth | Groove Radius |
| 4-inch | 4.06 inches (+0.10/-0.03) | 0.38 inches (+0.03/-0.02) | 0.12 inches (+0.03/-0.02) | 0.120 inches |
| 6-inch | 4.06 inches (+0.10/-0.03) | 0.38 inches (+0.03/-0.02) | 0.13 inches (+0.02/-0.03) | 0.120 inches |
| 8-inch | 4.18 inches (+0.06/-0.06) | 0.50 inches (+0.03/-0.02) | 0.15 inches (+0.02/-0.05) | 0.145 inches |
| 12-inch | 4.75 inches (+0.09/-0.04) | 0.50 inches (+0.03/-0.02) | 0.15 inches (+0.04/-0.03) | 0.145 inches |

Installing Field Flex-Ring

Once a proper AWWA C606 groove has been created at the specified distance from the spigot end, the specified coating system shall be applied to the grooved section, unless otherwise specified. Once the coating is dry to the touch install the Field Flex-Ring into the groove with the square side of the ring facing the spigot end, ensuring proper placement around the pipe (Photo 2). Using a 3/16-inch Allen wrench, tighten the bolt to approximately 3 to 5 ft-lbs of torque to snug ring in groove (not to exceed 9 ft-lbs of torque), making sure that the cleat on the ID of the spigot ring stays aligned with the groove on the pipe (Photo 4). The ring is sufficiently tight when the gap between the ends of the ring has almost completely closed and when it requires tapping on the ring with a hammer to make it move back and forth in the groove. Coat the installed Field Flex-Ring with the specified coating system, unless otherwise specified. (Photo 3) Once sufficiently dry, proceed with the 4- to 12-inch Flex-Ring assembly instructions.

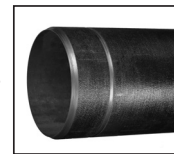

Photo 1



Photo 2



Photo 3



Photo 4



AMERICAN Ductile Iron Flex-Ring® Joint Pipe

Field Flex-Ring®

14"-36"

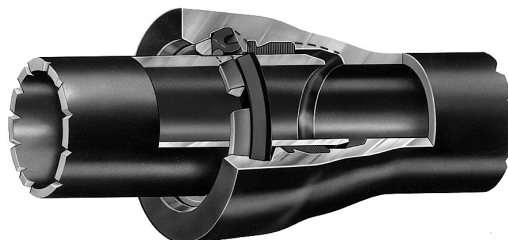

The AMERICAN Field Flex-Ring with black-toothed gripping segments is an integral part of the AMERICAN Flex-Ring Joint restraint system. The AMERICAN Field Flex-Ring method of restraining AMERICAN 14"-36" ductile iron Flex-Ring pipe and fittings is an easy, totally boltless and glandless way of restraining field connections, which also does not require a factory or field weldment. Where field cuts are anticipated, the Field Flex-Ring may be used to restrain joints with any suitable ductile iron plain end or cut pipe, for water service in lieu of a standard Flex-Ring joint spigot with a factory welded-on bead.

The patented* AMERICAN Field Flex-Ring is designed to restrain joints using Flex-Ring sockets with the same allowable working pressures and deflection capabilities as the standard Flex-Ring joint. (See Table 9-2.) Field Flex-Rings may be used with any standard pressure class of ductile iron pipe with an allowable working pressure equal to that of the pipe class, or a maximum of 350 psi in the 14"-24" sizes and 250 psi in the 30" and 36" sizes. Flex-Ring fittings are manufactured per ANSI/AWWA C110/A21.10 or ANSI/AWWA C153/A21.53.

Restrained joints using Field Flex-Ring have been thoroughly factory tested to withstand dead end thrust resulting from more than twice the rated working pressure. The restraint is provided by the wedging action of heat-treated, high-strength ductile iron segments. The segments have a wedge-shaped cross-section with gripping teeth on the inner surface.

The ductile iron segments are held in the proper position for assembly by a rubber backing ring. This rubber backing ring is compressed during assembly to ensure that the restraining segments are held firmly in place against the socket wedging surface and spigot. The positioning and compressive force exerted by the backing ring on the restraining segments result in dependable gripping of the spigot when thrust is applied.

The rubber backing ring for the Field Flex-Ring does not perform any sealing function for the joint. (A separate, standard Fastite gasket is employed in the joint for this purpose.) The backing ring is made of gasket-quality SBR rubber which meets all the material requirements of ANSI/AWWA C111/A21.11, Rubber-Gasketed Joints for Ductile-Iron Pressure Pipe and Fittings.



AMERICAN Ductile Iron Flex-Ring® Joint Pipe Field Flex-Ring® 14"-36" Assembly Instructions

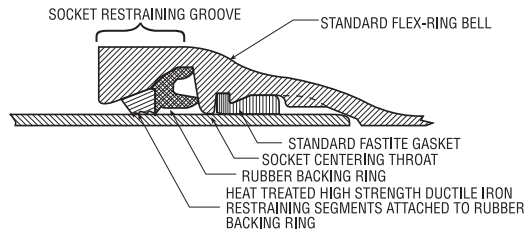

1) Cleaning, gasket insertion, spigot marking and lubrication of the joint

Remove the standard flex-ring with yellow metal segments from the socket, if present. Place an assembly mark on the spigot plain end located as shown in Table No. 9-4.

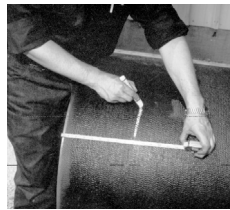

Thoroughly clean the socket restraining groove (nearest the bell end), the Fastite gasket recess, and the pipe plain end, removing dirt, sand, ice, mud, or any other material that could prevent the proper placement of the Field Flex-Ring or Fastite gasket. As in normal Fastite joint assembly, insert the gasket into the gasket socket grooves, then lubricate the inside surface of the gasket.



Important : A Fastite gasket must be used as the Field Flex-Ring does not perform any sealing function. Lubricate the first four inches of the spigot, including the

Spigot Assembly Stripe Location

Table No. 9-4

| Pipe Size in. | Location of Stripe from spigot end |
|---------------|------------------------------------|
| 14-16 | 7 1/4" |
| 18-20 | 8 1/16" |
| 24 | 8 13/16" |
| 30-36 | 9 1/2" |

pipe end and bevel. Do not allow the spigot end of the pipe to touch the ground after it is lubricated.

2) Placement of the Field Flex-Ring in socket

Remove the Field Flex-Ring with black-toothed gripping segments from its container and



place it in the socket restraining groove (nearest to the bell end) in gasket-like fashion. The metal restraining segments of the

Field Flex-Ring should be oriented toward the entering spigot. This may be done by first placing the Field Flex-Ring in the groove at the bottom of



the socket, so that the rubber backing ring is fitted flush against the radial surface of the socket centering throat.

The rubber ring may then be worked into the restraining groove around the sides of the socket



until a loop is formed at the top. At this time, the formation of a second smaller loop at the bottom of the socket will

facilitate placement of the first looped section into the top of the socket restraining groove.



It is often easier to properly insert the top loop of the Field Flex-Ring by pushing it axially into the socket after it has been allowed to protrude beyond the face of the bell. The second smaller loop may then be pushed radially outward into the restraining groove.

Any bulges present in the rubber backing ring after it is placed in the socket should be removed. This may normally be done by simply pushing the protruding rubber radially outward. Some bulges may require forming a small loop



in the ring opposite the bulge. The ring may then be allowed to slide circumferentially around the socket toward the loop, thus relieving rubber compression in the bulging area. Make sure that the angled bearing surface of the segments are secure against the socket, and the toothed side of the segments are facing inward. This should be done by examining and pushing each segment toward the back of the socket until the rubber backing ring is firmly in place against the socket centering throat.

3) Initial placement of beveled plain end into socket

With the spigot in reasonably straight alignment and centered within the Field Flex-Ring, insert the spigot until it contacts the back of the socket per normal Fastite joint assembly procedure. Joint deflection may be taken immediately after assembly. Verify correct position of the locking segments in the fully assembled joint.

(Note: The complete insertion of a factory supplied spigot stripe on a Fastite pipe into the deeper Flex-Ring socket does not indicate full assembly. The use of a field-applied assembly mark is recommended.)



4) Field-cut pipe

A) Selecting pipe: When possible, an appropriate pipe to be field cut should be selected before it is required. This may be done by measuring the outside diameter or circumference of the pipe at the location to be cut. The measured diameter or circumference of the candidate pipe should be within the ranges shown in Table No. 9-5. In 18" and larger sizes, the ordering and use of a few select pipes that have been gauged full length at the factory should be considered when field cuts are anticipated.

B) Preparing pipe end when making a field cut: The cut end must be properly prepared prior to assembly. The pipe should be cut as square as possible with the pipe axis and beveled on the outside extreme end after cutting.



A portable grinder should be used to make a bevel 3/8" to 5/8" long at an angle of 30-40° with the axis of the pipe. All sharp corners or rough edges that might damage or dislodge the Fastite gasket or Field Flex-Ring should be removed from the beveled pipe end.

Table No. 9-5 Recommended Spigot Diameters at Pipe Field-Cut Locations

| Pipe Size in. | Diameters | | Circumference | |
|---------------|-----------|----------|-----------------------------------|-----------------------------------|
| | Min. in. | Max. in. | Min. in. | Max. in. |
| 14 | 15.22 | 15.35 | 47 ¹³ / ₁₆ | 48 ⁷ / ₃₂ |
| 16 | 17.32 | 17.45 | 54 ¹³ / ₃₂ | 54 ¹³ / ₁₆ |
| 18 | 19.42 | 19.55 | 61 | 61 ¹³ / ₃₂ |
| 20 | 21.52 | 21.65 | 67 ¹⁹ / ₃₂ | 68 |
| 24 | 25.72 | 25.85 | 80 ¹³ / ₁₆ | 81 ⁷ / ₃₂ |
| 30 | 31.94 | 32.08 | 100 ¹¹ / ₃₂ | 100 ²⁵ / ₃₂ |
| 36 | 38.24 | 38.38 | 120 ¹ / ₈ | 120 ⁹ / ₁₆ |



C) Rounding Clip Set:

Rounding clips* are available from AMERICAN and are helpful when making a

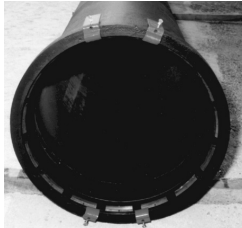

joint using an out-of-round field-cut end. These clips may be readily attached to a Flex-Ring bell containing a Field Flex-Ring to quickly and easily round a pipe spigot during insertion assembly.

When using rounding clips with a severely oval field-cut pipe, they may be placed at the 12:30, 5:30, 6:30, and 11:30 o'clock** positions. The spigot should then be oriented with the maximum diameter in a vertical position and, while in reasonably straight alignment, centered within the funnel formed by the rounding clips. The spigot will then be automatically rounded when inserted into the socket. The rounding clips should then be removed after assembly and reused as needed.

* U.S. Patent No. 5,426,842

** Due to actual field conditions and pipe shape, adjustment of rounding clip locations may be needed.

5) Assembly of fittings

Flex-Ring pipe and fitting joints using Field Flex-Rings can be assembled with the same tools and methods used for many years with Fastite joints. When using a fieldcut pipe to locate a fitting, it may be advantageous to use a standard Flex-Ring spigot with a factory weld bead and a standard flex-ring with yellow metal segments in the fitting rather than pipe socket. A Field Flex-Ring with black-toothed gripping segments and cut pipe plain end may then be used in the nearest pipe socket on either side of the fitting. When possible, the use of a standard flex-ring and a factory spigot with weld bead in the sockets of a cumbersome fitting may allow easier orientation or rotation of the fitting relative to the pipe after assembly. The use of a pipe socket with a Field Flex-Ring may also facilitate easier alignment of the joint during insertion assembly and installation. (See Section 4 for additional detail on the assembly of Fastite fittings.)

6) Deflection

Flex-Ring joints using Field Flex-Rings have an allowable deflection equal to those of standard Flex-Ring joints (Table No. 9-2). Deflection may be taken immediately after full insertion of the spigot into the socket.

7) Joint extension after installation

The Field Flex-Ring locking mechanism is activated by relative movement between the socket and spigot. This allows for movement, joint take-up and substantial flexibility after installation. The joints may be extended after assembly to minimize joint take-up in test or service conditions. This may be accomplished by pulling or jacking the spigot away from the socket until firm resistance is encountered. This will not limit joint deflection.

In vertical applications, such as exposed risers, standard (weld bead) Flex-Ring joints that also should be effectively extended and braced in original installation are required instead of Field Flex-Rings.

In most underground installations (including most restrained bend locations), joint take-up is advantageous in that increased thrust-resisting forces are generated. Also, expansion and contraction due to temperature variations may be accommodated without excessive stress in pipe members. The amount of joint take-up or line movement in buried restrained pipelines is substantially limited by the surrounding soil. Therefore, system security and safety is maximized by filling and testing restrained sections of pipelines after backfilling as recommended by ANSI/AWWA C600, [Installation of Ductile Iron Water Mains and Their Appurtenances](#) and AWWA M41.

In any application where axial or lateral movement may be undesirable, such as some exposed or unburied piping applications, or certain connections of restrained pipe sections to rigid piping, special provisions, including effective joint extensions, may be necessary to control unacceptable pipeline movement. Depending on job conditions and restrained pipe length, cumulative joint take-up can be substantial, particularly in exposed piping applications.



8) Disassembly instructions

Flex-Ring joints containing Field Flex-Rings may normally be disassembled if required. Field Flex-Ring disassembly kits, consisting of a shim holder and high-strength disassembly shims, are available from AMERICAN. (Use Fast-Grip disassembly kits for the 14"-16" sizes.) In some cases, due to the time and effort involved for disassembly of these joints, it may be preferable to disassemble the pipeline at the nearest standard Flex-Ring (using a standard flex-ring and spigot weld bead) or other joint. In this manner, the Field Flex-Ring-joined pipes and/or fittings can be removed as a unit.

If joint disassembly is required, a disassembly kit should be used in accordance with the procedure below to separate a Flex-Ring joint containing a Field Flex-Ring.

Disassembly Procedure:

A) If the joint has been subjected to separating thrust, movement, or joint deflection, first push the spigot back into the rear of the socket so as to "unwedge" the straining segments.



B) Using gloves to protect hands from sharp edges, insert the long end of a disassembly shim fully into the groove in the shim holder. Two lengths of shims are supplied with the 18"-36" disassembly kit for customer convenience. The shorter shims may often be easier to use in some hard-to-reach locations such as the bottom of a joint, or when a small gap exists between the longer shims.



C) Carefully drive a disassembly shim between the gripping teeth of the segments and the spigot with a hammer. Lifting or offsetting of the spigot relative to the socket (to relieve

metal-to-metal contact) may be required to insert some shims. It is sometimes easier to start a shim under the teeth if the holder is initially placed near one end of the shim (off center) so that one corner of the shim is inserted first. The holder may then be slid along the shim to start the middle, while the other end of the shim is placed under the teeth.

D) When properly in place, the end of the shim should be visible 1/4" to 3/4" outside the socket for the 14"-16" sizes and 1 1/2" to 2" for the 18"-36" sizes. Remove the holder from the shim and progressively place other shims around the joint. It is often easier to drive a shim under the teeth if the edge of one shim is initially inserted 1/8" to 1/4" under the previously placed shim. Shims should be in contact with one another to ensure all teeth are disengaged from the spigot. Overlapping of some shims may be required to dislodge all teeth.



E) After all shims are inserted, place a reference mark on the spigot even with the exposed end of the shims. Pull, jack, or deflect the spigot

out from the socket. After the spigot has been pulled from the socket approximately 1 1/2" to 2", check the positioning of each shim. Any shim found to have been pulled out of the socket 1/2" or more from its original position should be tapped back into the socket. The procedure of pulling the spigot out of the socket 1 1/2" to 2" and adjusting the shim positioning may have to be repeated several times before the joint is completely disassembled. *NOTE: The measured distance between the reference mark on the pulled-out spigot and the exposed edge of the shims (when shims are fully in place inside the socket) is indicative of the length of spigot removed from the socket. A very tight joint may have to be separated by cutting the pipe with a pipe saw or oxyacetylene torch.*



AMERICAN DUCTILE IRON PIPE

AMERICAN Ductile Iron Lok-Ring® Joint Pipe

**Centrifugally Cast for Water, Sewage, or Other Liquids
60"-64"**

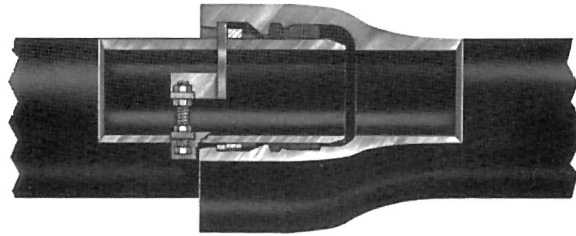

The AMERICAN Lok-Ring® Joint is another restrained joint that utilizes the sealing features of the time-proven AMERICAN Fastite Joint. It is an essentially boltless, flexible restrained connection that provides an easily assembled positive restraint against endwise separation due to thrust resulting from internal pressure or external forces. Only a minimal amount of time is required to complete the Lok-Ring assembly, or disassembly if necessary.

The patented* AMERICAN Lok-Ring® Joint is designed for working pressures up to 250 psi for sizes 60" and 64". It can be used with any lesser pressure class of ductile iron pipe with the maximum operating pressure rating of the joint limited in such cases to that of the pipe. An alloy steel welded-on retainer ring and a split lok-ring, assembled behind the retainer ring, provide the means of restraint. The split lok-ring is held "snug" against the pipe O.D. for assembly of the AMERICAN Fastite portion of the joint. After the plain end of the pipe is assembled into the Lok-Ring bell, the lok-ring is released, permitting it to expand. The lok-ring is thus securely positioned behind the welded-on retainer ring and in the socket locking groove on the I.D. of the Lok-Ring bell. This locks the joint.

The joint can be easily disassembled if the need arises, using the closure-spreader mechanism provided for this purpose. The lok-ring, welded retainer ring and all parts of the closure-spreader mechanism are all constructed of cor-

rosion-resistant, high-strength, low-alloy (HSLA) steel. This is the same type steel specified for bolting material per ANSI/AWWA C111/A21.11. The alloy steel of the lok-ring and the welded retainer ring is also the same material that has been used successfully in several AMERICAN restrained joint constructions for approximately 40 years. The weld is aluminum bronze (also as was used in the Lok-Fast Joint), and both the weld and ring are cathodic to, and thus protected by, the greater area of the ductile iron pipe. Welding is performed using welders qualified to produce high-quality, dependable welds.

Standard Fastite gaskets and lubricant are used with the AMERICAN Lok-Ring® Joint. (See Section 2 for gasket compounds.) AMERICAN recommends underwater lubricant where the joint is to be assembled in very wet conditions or under water.

The AMERICAN Lok-Ring® Joint is designed to permit deflection in order to facilitate installation and accommodate settlement. It may be safely deflected after assembly to the limits shown in Table No. 9-7. These deflection values have proven adequate for thousands of Lok-Ring joints furnished over the past several years and exceed the deflection capabilities of many types of restrained joints that have performed successfully for many years in buried service. It is noted that rotation of the lok-ring under great loads helps to distribute the forces substantially around and between the bell and spigot members.

* U.S. Patents 4,428,604 and 4,524,505.



AMERICAN Ductile Iron Lok-Ring® Joint Pipe

Centrifugally Cast for Water, Sewage, or Other Liquids

AMERICAN Lok-Ring® Pipe is ductile iron, grade 60-42-10, manufactured and tested in accordance with AWWA C151. It is normally furnished standard asphaltic coated outside and cement lined in accordance with AWWA C104. When specified, other special coatings or linings can be furnished as described in Section 11.

A full complement of AMERICAN Lok-

Ring ductile iron fittings is available. These fittings are available in both bell-bell and bell-plain end configurations for installation versatility and economy. Lok-Ring fittings meet applicable requirements of ANSI/AWWA C153/A21.53 and are pressure rated for at least 250 psi in most configurations. Check AMERICAN if higher pressure is required. See Section 4.

Standard Dimensions

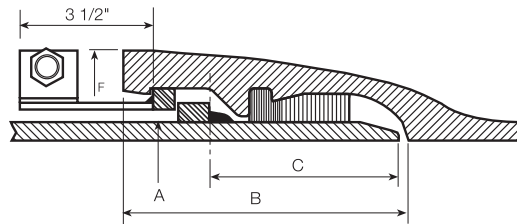

Table No. 9-6

| Size in. | Working Pressure* psi | Nominal Laying Length† ft. | A Outside Diameter in. | B Socket Depth in. | C Plain End to Retaining Ring in. | F Bell O.D.†† in. | Retainer Ring | Lok-Ring |
|----------|-----------------------|----------------------------|------------------------|--------------------|-----------------------------------|-------------------|---------------|---------------|
| 60 | 250 | 20 | 61.61 | 10.57 | 6.38 | 66.27 | 3/4" x 1 1/4" | 3/4" x 1 1/4" |
| 64 | 250 | 20 | 65.67 | 10.57 | 6.38 | 70.45 | 3/4" x 1 1/4" | 3/4" x 1 1/4" |

*Working pressure is the maximum pressure rating of the joint and is based on its capability to resist thrust due to internal pressure. If higher working pressure is required, check AMERICAN.

†Laying length is nominal 20 feet. Where exact lengths are required, contact AMERICAN. (See minimum laying lengths in Table No. 9-6.)

††Dimensions subject to change at our option. Check AMERICAN if smaller or exact dimensions are required. Note that the struts may protrude slightly above the bell in one spot; contact AMERICAN if this may be critical to the application.



AMERICAN Ductile Iron Lok-Ring® Joint Pipe

Minimum Laying Lengths

Table No. 9-7

| Size in. | Lok-Ring & Lok-Ring End | Lok-Ring End & Lok-Ring End |
|----------|-------------------------|-----------------------------|
| 60 | 2'-6" | 3'-0" |
| 64 | 2'-6" | 3'-0" |

Allowable Joint Deflection

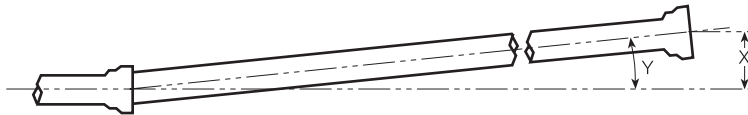

Table No. 9-8

| Size in. | Nominal Laying Length ft. | Maximum Recommended Deflection | |
|----------|---------------------------|--------------------------------|--------------------|
| | | X Offset* per Length in. | Y Deflection Angle |
| 60 | 20 | 2 | 1/2° |
| 64 | 20 | 2 | 1/2° |

*Offset distances are based on 20' lengths of pipe.



AMERICAN Ductile Iron Lok-Ring® Joint Pipe Assembly Instructions

Thoroughly clean the socket locking groove as well as the Fastite gasket recess and pipe plain end, being sure to remove any mud, gravel, or any other foreign matter. Insert standard Fastite gasket and lubricate the joint components in accordance with standard Fastite assembly instructions and, with pipe in essentially straight alignment, assemble the plain end into the Lok-Ring bell. **(Photos 1 & 2.)** Assembly tools shown in **Photo 2** are available from AMERICAN on a rental basis for installers not electing assembly with a backhoe or other like equipment.

Once the spigot is completely inserted as evidenced by the spigot stripe disappearing into the bell (the orientation of the spigot stripe in relationship to the bell face is an indication of pipe alignment), loosen the outside stud closure nuts fully to the end of the stud to allow the lok-ring to spring outward and into the socket locking groove.* In lieu of the outside stud closure nut provided for this purpose, some installers prefer to install a "quick release" locking clamp or grip device beforehand (e.g., "outside the trench") and back the outside closure nut out of the way for very rapid assembly. **(Photo 3.)** The correct seating** of the lok-ring in the socket locking groove should be accompanied by an obvious spreading of the lok-ring struts. If

inspection around the joint reveals that the lok-ring is not completely seated in the annular socket locking groove at any location, the lok-ring may be completely seated by tapping the loose lok-ring into the socket locking groove with a flat caulking tool and/or by moving the entering pipe slightly. When a visual inspection to determine the lok-ring position is not practical, such as in an underwater installation, **a feeler gauge can be used to ensure that the lok-ring is correctly seated in the socket locking groove all around the joint. (Photo 4.)**

Once the lok-ring is correctly seated in the socket locking groove, turn the inside stud spreader nuts out firmly against the struts **(Photo 5.)** as shown to ensure firm contact of the lok-ring in the socket locking groove. **During the lok-ring spreading operation, the outside stud closure nuts should be positioned so as not to restrict the outward movement of the drilled struts on the stud.** (The outside stud closure nuts perform no function in the finished joint; however, these closure nuts can be used to effect simple disassembly of the joint, if required, by reversing the assembly procedure outlined above.) Once the inside spreader nuts are properly positioned, the lok-ring is positively secured in the socket locking groove.

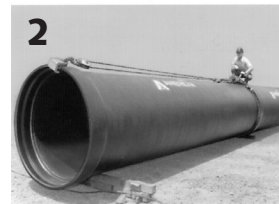
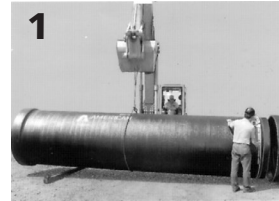

***Note:** The lok-ring is normally shipped in position on the pipe plain end behind the welded-on retainer ring. See page 9-25 if field assembly of lok-ring is required.

****Note:** It is **imperative** that the installer verify that the lok-ring is seated outward in the socket locking groove **completely** around each joint. Lok-rings are painted yellow to visually aid in this verification.



AMERICAN DUCTILE IRON PIPE

"Backward" installation. AMERICAN does not recommend "backward laying" (bells assembled over spigots, rather than spigots inserted into bells as pictured in this literature) of large-diameter ductile iron pipe in buried installations. AMERICAN can furnish bell and plain end fittings to minimize the need for backward pipe laying.

Other devices such as sleeves and couplings may also be employed for this reason. However, if this condition cannot be avoided, we strongly recommend that installers contact AMERICAN for instructions on how to reduce the potential for problems that could occur when assembling pipe in this manner.

FIELD ASSEMBLY OF LOK-RING

Should it be necessary to place the lok-ring on the pipe spigot in the field, unscrew and remove one outside stud closure nut to permit the lok-ring to be spread and positioned on the plain end of the pipe behind the welded-on retainer ring.

To complete field placing of the lok-ring on the pipe, reassemble the outside stud closure nut and tighten both outside stud closure nuts to pull lok-ring substantially flush against the pipe barrel and immediately behind the welded-on retainer ring.

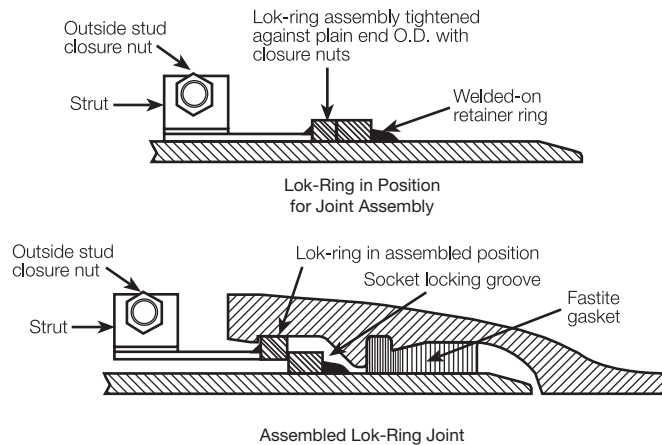

NOTE: The AMERICAN Lok-Ring Joint allows for joint take-up after installation. In most underground installations, including most restrained bend locations, this feature is advantageous in that increased thrust-resisting soil forces are generated. Also, expansion and contraction due to temperature variations may be accommodated without excessive stress in the pipe members.

In any application where axial or lateral movement may be undesirable, such as certain bridge crossings, certain other exposed or unburied piping applications, or certain connections of restrained pipe sections to rigid piping, special design or installation provisions, including effective joint extension, may be necessary to control any unacceptable pipeline movement.

Depending on job conditions and restrained pipe length, cumulative joint take-up can be substantial, particularly in exposed or unburied piping applications. In this regard, joints may be extended after assembly to minimize further joint take-up in test or service.

The amount of joint take-up or line movement in buried restrained pipelines is substantially limited by the surrounding soil. Therefore, system security and safety is maximized by filling and testing restrained sections of pipelines **after backfilling** as recommended by ANSI/AWWA C600, [Installation of Ductile Iron Water Mains and Their Appurtenances](#) and AWWA M41.



The AMERICAN Earthquake Joint System



The AMERICAN Earthquake Joint System combines the rugged, tough, and time-proven deflection performance of AMERICAN's Flex-Ring restrained joint pipe with the capacity to expand and contract.

The system is built around a ductile iron Earthquake System casting that features in its design an extended socket depth allowing the specially placed Flex-Ring weld ring an expansive range of motion.

The ductile iron Earthquake System casting and Flex-Ring connecting piece arrive at the jobsite pre-assembled by our professional staff at our manufacturing plant. The extended socket receives a special Flex-Ring spigot end with a specially located restraining ring. The pre-assembled Earthquake System spigot has a double stripe, one showing full insertion and the other mid-point insertion. The illustration above shows the joint installed in the fully extended position, such that both assembly stripes are fully visible.

Pre-assembly means the on-site contractor needs to assemble only the familiar and conventional Flex-Ring joint. In this application, the Flex-Ring spigot on the ductile iron Earthquake System casting is red in color and machined

instead of welded. Conventionally, it's a Flex-Ring joint and is assembled in the field in the same manner.

The AMERICAN Earthquake System joint may be assembled in the fully contracted position, allowing for maximum expansion; it may be assembled in the mid-point position, allowing for both joint expansion and contraction; or it may be assembled in the fully extended position, allowing for maximum joint contraction.

The more common is the mid-point position, which allows for both expansion and contraction during a seismic event.

After assembly, the AMERICAN Earthquake Joint System can expand and contract longitudinally and deflect at both joints. With deflection from the conventional Flex-Ring joint and additional deflection from the extended socket Flex-Ring joint, the assembly provides 8 degrees deflection for 6", 8" and 12"; 7 degrees for 16"; and 6 degrees for 20" and 24"; 5 degrees for 30"; as well as 2.4 inches of either expansion or contraction. If assembled in the fully contracted or fully extended position, 4.8 inches of one-way longitudinal differential is available.

Standard Dimensions

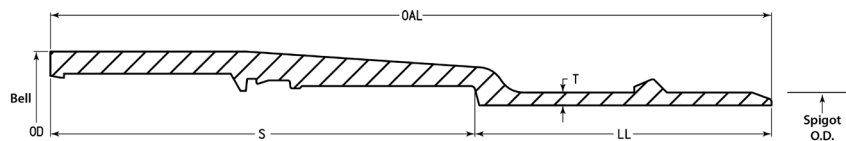

Table No. 9-9

| Size (in.) | Working Pressure ¹ (psi) | Earthquake Casting OAL (in.) | Earthquake Casting LL (in.) | Socket Depth (S) (in.) | Thickness (T) (in.) | Bell OD (in.) | Spigot OD (in.) |
|------------|-------------------------------------|------------------------------|-----------------------------|------------------------|---------------------|---------------|-----------------|
| 6 | 350 | 25.63 | 10.53 | 15.10 | 0.43 | 9.54 | 6.9 |
| 8 | 350 | 25.93 | 10.71 | 15.22 | 0.45 | 11.78 | 9.05 |
| 12 | 350 | 27.60 | 11.38 | 16.22 | 0.49 | 16.34 | 13.2 |
| 16 | 350 | 31.75 | 14.31 | 17.44 | 0.70 | 20.54 | 17.40 |
| 20 | 350 | 32.20 | 15.02 | 17.18 | 0.80 | 25.20 | 21.60 |
| 24 | 350 | 33.70 | 16.44 | 17.26 | 0.89 | 29.46 | 25.80 |
| 30 | 250 | 34.25 | 16.70 | 17.55 | 0.95 | 36.00 | 32.00 |

¹Working pressure is the maximum pressure rating of the joint and is based on its capability to resist thrust due to internal pressure. If higher working pressure is required, contact AMERICAN.



AMERICAN DUCTILE IRON PIPE

Standard Dimensions (Continued)

Nominal full laying lengths for AMERICAN Earthquake Joint System assembled with AMERICAN Flex-Ring Joint Pipe*

Table No. 9-10

| Size (in.) | Casting Fully Homed | Casting at Midpoint of Insertion | Casting Fully Extended | Casting Weight (lbs.) |
|------------|---------------------|----------------------------------|------------------------|-----------------------|
| 6 | 20'-9.57" | 21'-0.32" | 21'-2.74" | 104 |
| 8 | 20'-9.75" | 21'-0.54" | 21'-2.95" | 140 |
| 12 | 20'-9.34" | 21'-0.21" | 21'-2.65" | 263 |
| 16 | 20'-11.79" | 21'-2.80" | 21'-5.63" | 419 |
| 20 | 21'-0.02" | 21'-2.76" | 21'-5.07" | 610 |
| 24 | 21'-1.44" | 21'-4.18" | 21'-6.56" | 779 |
| 30 | 21'-1.31" | 21'-4.03" | 21'-6.76" | 1,088 |

* Subject to trim pipe allowances per AWWA C151. Where exact lengths are required, contact AMERICAN.

Table No. 9-11

| Size (in.) | Working Pressure ¹ (psi) | Earthquake Casting OAL (in.) | Allowable Deflection (degrees) | Offset Per Nominal Assembly LL (in.) | Radius of * Curvature (ft.) |
|------------|-------------------------------------|------------------------------|--------------------------------|--------------------------------------|-----------------------------|
| 6 | 350 | 25.63 | 8 | 35.12 | 150 |
| 8 | 350 | 25.93 | 8 | 35.15 | 150 |
| 12 | 350 | 27.60 | 8 | 35.10 | 150 |
| 16 | 350 | 31.75 | 7 | 31.05 | 174 |
| 20 | 350 | 32.20 | 6 | 26.63 | 203 |
| 24 | 350 | 33.70 | 6 | 26.78 | 204 |
| 30 | 250 | 34.25 | 5 | 22.31 | 245 |

* Based on midpoint position.

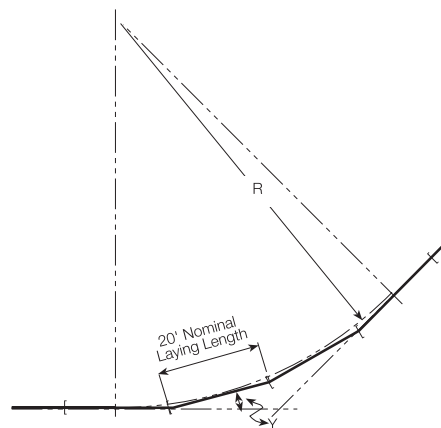

R = Radius of Curve (ft.)

Y = Deflection Angle (degrees)

$$\text{Radius of Curve} = \frac{\text{Nominal Laying Length}}{2 \times \text{Tangent } (Y \div 2)}$$



Suggested Specification

As required on the project plans and in these specifications, in high-risk areas subject to sudden and permanent ground deformations, a ductile iron system shall be provided that delivers joint deflection and longitudinal expansion and contraction. This system shall be the AMERICAN Earthquake Joint System or a system equal to or exceeding each of these performance criteria:

Table No. 9-12

| Size (in.) | Pipe Joint Deflection | Casting Joint Deflection | Combined Assembly Deflection | Longitudinal Extension from Mid-Point | Ultimate Dead End Thrust Resistance | ISO 16134 Rating |
|------------|-----------------------|--------------------------|------------------------------|---------------------------------------|-------------------------------------|------------------|
| 6 | 5 degrees | 3 degrees | 8 degrees | ± 1.00% (2.40 inches) | 102,900 lbs | A,M1,S1 |
| 8 | 5 degrees | 3 degrees | 8 degrees | ± 1.00% (2.40 inches) | 137,200 lbs | A,M1,S1 |
| 12 | 5 degrees | 3 degrees | 8 degrees | ± 1.00% (2.40 inches) | 205,800 lbs | A,M1,S1 |
| 16 | 3.75 degrees | 3.25 degrees | 7 degrees | ± 1.00% (2.40 inches) | 274,400 lbs | A,M2,S1 |
| 20 | 3.5 degrees | 2.5 degrees | 6 degrees | ± 1.00% (2.40 inches) | 343,000 lbs | A,M2,S1 |
| 24 | 3 degrees | 3 degrees | 6 degrees | ± 1.00% (2.40 inches) | 411,600 lbs | A,M2,S1 |
| 30 | 2.5 degrees | 2.5 degrees | 5 degrees | ± 1.00% (2.40 inches) | 514,500 lbs | A,M2,S1 |

The ductile iron earthquake resistant pipe shall meet all applicable requirements of AWWA C150 (design), AWWA C151 (manufacture), AWWA C104 (lining), C111 (joints), AWWA C153 (fittings), AWWA C105 (polyethylene encasement), and AWWA C600 (installation). The ductile iron pipe shall be sized in inches.

The piping shall meet defined classifications detailed below as shown in ISO 16134 Earthquake Resistant Ductile Iron Pipe and Subsidence-Resistant Design. The seismic design shall be verified by an independent seismic lab such as Cornell University or an owner-approved alternative.

1. All ductile iron pipe and fittings joints shall meet or exceed 3dKN pull out strength or category A.
2. Designated Earthquake System piping shall meet or exceed a minimum deflection of 8 degrees for category M1 for sizes 6" - 12", between 4 degrees to 8 degrees for category M2 for 16", and between 3.5 degrees to 7 degrees for category M2 for sizes 20" and above, whether in the mid-point, fully inserted, or fully extended positions.
3. Designated ductile iron Earthquake System piping will have a minimum strain relief of plus or minus 1% or category S1.

As a designation, the minimum requirements would be A, M1, S1 per ISO 16134 for sizes 6" - 12" and A, M2, S1 for sizes 16" and above, unless otherwise shown on plans and specifications.

The network of ductile iron pipe connected to the Earthquake Joint System shall have the exterior of the pipe coated with a layer of arc-sprayed zinc. The mass of the zinc applied shall be a minimum of 200 g/m² of pipe surface area, and the coating system shall conform in every respect to ISO 8179-1, "Ductile Iron Pipes - External Zinc-Based Coating - Part 1: Metallic Zinc with Finishing Layer," third edition 2017. The zinc shall have a top coat of approved materials. (Component pieces and field touch up may require the use of a zinc-rich coating 85% zinc per ISO-8179-part 2).

The Earthquake System piping will be installed in the fully open, fully closed, or mid-point position per design criteria. To facilitate determining field joint alignment, the expansion spigot in the assembly shall have a minimum of two assembly stripes – one indicating fully contracted and one indicating the mid-point of extension. Full extension can be achieved by pulling the completed joint out until the joint stops movement.

In addition, the connected network of ductile iron pipe shall be encased in 8 mil V-Bio polyethylene encasement meeting the requirements of AWWA C105 concerning both materials and installation.

The pipeline will be installed with a locator tape that identifies the buried line as an earthquake resistant pipeline. The tape will be a minimum 2 inches in width and red in color labeled "Earthquake Resistant Pipeline Below."



The AMERICAN Earthquake Joint System

Assembly Instructions – 6-inch, 8-inch and 12-inch

General Note: The assembly of the AMERICAN Earthquake Joint System relies on the efficient and proven assembly features of the AMERICAN Flex-Ring joint. This system can be field assembled with various pushing or pulling devices and rigging to provide the nominal Fastite gasket assembly force of 100-300 lbs. times the outside diameter in inches.

The enhanced strain and deflection capabilities of the Earthquake system should be maximized by careful field positioning of a central ductile iron Earthquake casting bell joint. The design of this joint features an extended socket depth, allowing the extended Flex-Ring weld ring on the Earthquake spigot end an expansive range of motion.

1. Ensure the required material to assemble and extend the joint is available. This includes the Flex-Ring locking ring, Fastite gasket, AMERICAN Fastite lubricant, one lever hoist, two choker cables, one hydraulic ram and one split restraining gland. Prior to joint insertion, remove the full-length strap (Figure 1) as well as the packing material holding the split Flex-Ring onto the casting spigot (Figure 2), unless Flex-Rings have been shipped separately.

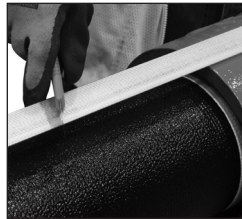

Figure 1



Figure 2

2. Thoroughly clean the pipe socket locking groove, the Fastite gasket recess and casting plain end in accordance with standard 4- to 12-inch Flex-Ring and Fastite joint assembly instructions.

3. In accordance with standard Fastite joint assembly instructions, insert the Fastite gasket ensuring gasket is flush without protrusions. Lubricate the inside surface of the gasket and the red plain end of the casting up to the ring abutment, paying close attention to the beveled nose end of the casting. Ensure the lubricated portion of the casting does not come in contact with the ground to ensure dirt and debris do not contaminate the surface during assembly.

4. With the pipe in essentially straight alignment, assemble the casting spigot end into the Flex-Ring pipe socket until the spigot stripe disappears into the bell. The orientation of the spigot stripe relative to the bell face is an indication of pipe alignment. For the most control and least disturbance of the intended position of the opposite Earthquake Joint and any previously installed joint, assembly of the joint with a lever hoist and two choker slings is recommended.



Figure 3

Assemble by installing one choker anchored around/behind the previously installed pipe bell and one anchored around the long bell cylinder of the Earthquake casting with the lever hoist between. Use the lever hoist to apply assembly force needed to position the joint fully homed (Figure 3).

5. Tap the split flex-ring into the bell's Flex-Ring socket beginning with one end of the split flex-ring and progressing around the joint (Figure 4). This operation is made easier by holding one end of the split flex-ring inside the bell as the remainder of the ring is tapped into the socket. Correct seating is generally indicated by a snapping noise as the split flex-ring springs into position.



Figure 4

Visually confirm the ring is fully in position (the split flex-ring is painted yellow to aid in this inspection). (Note: When a visual inspection to determine the



split flex-ring position is not practical, such as with underwater installations, a feeler gauge may be used to verify the correct positioning of the Flex-Ring in the socket locking groove. It may be necessary to move the entering pipe slightly to improve alignment if the ring does not readily spring into the socket locking groove.)

6. When the fully contracted position is not desired, extension can be performed with the use of a split restraining gland and one hydraulic ram to extend the Earthquake casting to the desired position. Install the split restraining gland on the Earthquake spigot with the leading edge facing away from the bell face. Distance should be sufficient to place a hydraulic ram (Figure 5). Once assembled in straight alignment per manufacturer instructions, place the hydraulic ram between the split restrained gland and Earthquake

casting bell face (Figure 6). Ensure consistent force is applied by the hydraulic ram until the desired placement is reached as indicated by assembly stripes.

7. Once the desired Earthquake stripe location has been reached, remove the hydraulic ram and split restraining gland. After removal of restraining gland ensure the pipe coating has not been damaged during extension. If coating damage has occurred during extension, repair coating per the AMERICAN coating repair procedure. The completed joint pictured in Figure 7 is in the intermediate position* as previously described, with the first assembly stripe of the opposite Earthquake joint fully inserted and flush with the bell face and the second stripe is fully exposed.



Figure 5



Figure 6

***Note:** The expansion/contraction position can be varied as desired by the positioning of the two assembly stripes of the bell joint of the Earthquake casting. When a position other than midpoint is desired, the stripe position can be adjusted by moving/telescoping the spigot of the Earthquake joint in or out the amount desired.

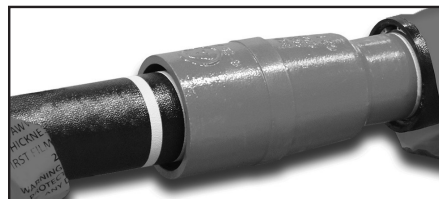

Figure 7



The AMERICAN Earthquake Joint System

Assembly Instructions – 16-inch, 20-inch, 24-inch and 30-inch

General Note: The assembly of the AMERICAN Earthquake Joint System relies on the efficient and proven assembly features of the AMERICAN Flex-Ring joint. This system can be field assembled with various pushing or pulling devices and rigging to provide the nominal Flex-Ring joint assembly force of 200-500 lbs. times the outside diameter in inches.

The enhanced strain and deflection capabilities of the Earthquake system should be maximized by careful field positioning of the iron Earthquake casting bell joint. The design of this joint features an extended socket depth, allowing the Flex-Ring weld ring on the Earthquake spigot end an expansive range of motion.

1. Ensure the required material to assemble and extend the joint is available. This includes (the rubber backed Flex-Ring, Fastite gasket, AMERICAN Fastite Lubricant, two lever hoists, four choker cables, two hydraulic rams and one split restraining gland). Remove the full-length strap. (Figure 1).



Figure 1



Figure 2

2. Thoroughly clean the pipe socket locking groove, the Fastite gasket recess area, and the casting plain end in accordance with standard 14-inch through 54-inch Flex-Ring and Fastite joint assembly instructions.

3. In accordance with 14- to 54-inch Flex-Ring joint assembly instructions, place the rubber-backed Flex-Ring in the socket restraining groove in gasket-like fashion. Ensure the yellow restraining segments are oriented toward the entering spigot and evenly spaced.

4. In accordance with standard Fastite joint assembly instructions, insert the Fastite gasket ensuring gasket is flush without protrusions. Lubricate the inside surface of the Fastite gasket (Figure 2) and the spigot end of

the casting up to the ring abutment, paying close attention to the beveled nose end of the casting. There is no need to lubricate the Flex-Ring rubber-backing ring or segments. Ensure the lubricated portion of the casting does not come in contact with the ground to ensure dirt and debris do not contaminate the surface during assembly.

5. With the pipe in essentially straight alignment, assemble the casting plain end into the Flex-Ring pipe socket until the spigot stripe disappears into the bell. The orientation of the ring abutment and spigot stripe relative to the bell face is an indication of pipe alignment. Correct assembly is generally indicated by an audible snap of the Flex-Ring segments into



Figure 3

the correct position; however, if any segment should not come down firmly on the casting, deflect the entering assembly slightly in that direction, allowing the segment to seat itself correctly. Verify the correct positioning of the yellow Flex-Ring segments by visual inspection or feeler gauge if conditions are limiting. The ring abutment is in the proper assembled position when it is fully beyond the yellow Flex-Ring segments and all segments are fully against the casting. For the most control and least disturbance of the intended position of the opposite Earthquake joint and any previously installed Earthquake castings, assembly of this joint using two lever hoists and four reasonably short choker slings is recommended. Assembly using two choker slings anchored around/behind the previously installed pipe bell and two anchored around the long bell cylinder of the Earthquake casting



with the two lever hoists between is best for applying the assembly force needed (Figure 3). Ensure even distribution of assembly force by tightening both lever hoists at the same rate.

6. When the fully contracted position is not desired, it is necessary to use a split restraining gland and two hydraulic rams to extend the Earthquake casting to the desired position. Install the split restraining gland on the Earthquake spigot with the leading edge facing



Figure 4

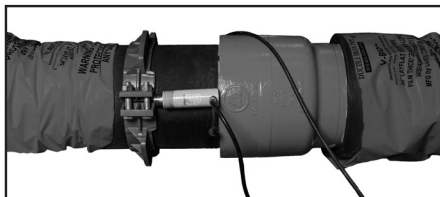

Figure 5

away from the bell face at a distance sufficient to place hydraulic rams (Figure 4). Once assembled in straight alignment per manufacturer's instructions, place the hydraulic rams between the split restraining gland and

Earthquake casting bell face. Ensure even and consistent force is applied by the hydraulic rams until the desired placement is reached as indicated by assembly stripes (Figure 5).

7. Once the desired EQ position has been reached, remove the hydraulic rams and split restraining gland. After removal of the restraining gland ensure the pipe coating has not been damaged during extension. If coating damage has occurred during extension, repair coating per the AMERICAN coating repair procedure. The completed joint pictured in Figure 6 is in the intermediate midpoint position* as previously described, with the first assembly stripe of the opposite Earthquake joint fully inserted and flush with the bell face, and the second stripe is fully exposed.

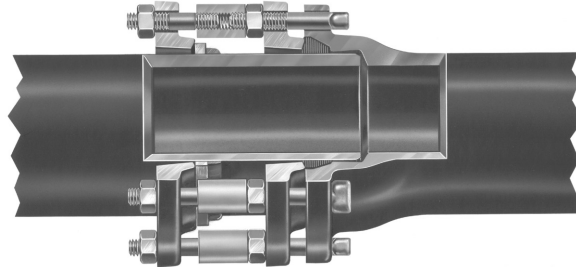

Figure 6

***Note: The expansion/contraction position can be varied as desired by the positioning of the two assembly stripes of the bell joint of the Earthquake casting. When a position other than midpoint is desired, the stripe position can be adjusted by moving/telescoping the spigot of the Earthquake joint in or out the amount desired.**



AMERICAN Ductile Iron MJ Coupled Joint Pipe



The MJ Coupled Joint offers a method of providing joint restraint with a standard Mechanical Joint socket of a pipe, fitting, valve, or other product. It is available in sizes 4"-12" with a pressure rating of 350 psi and deflection capability up to 2 1/2°, and in 14"-48" with a pressure rating of 250 psi intended for installation in essentially straight alignment. Check AMERICAN if larger sizes or greater deflections are desired. The MJ Coupled Joint is commonly used as a method of joint restraint for Mechanical Joint all bell fittings and valves.

The joint material consists of a standard MJ gasket and a standard ductile iron joint gland. The restraint gland* is ductile iron and is assembled on

the pipe behind a welded-on 1/2" square alloy steel retaining ring. Coupling nuts, studs, teehead bolts and nuts, and retaining ring are all alloy steel. Teehead bolts are special-length bolts.

* The restraint gland for 30"-48" sizes is a substantially rectangular cross-section ductile iron gland.

Note: It is sometimes possible to provide for field-cutting and positive, even "drop-in" field-adaptable restraint in restrained piping areas by using modified MJ Coupled joints where the weld ring and restraint gland are intentionally moved farther away from the joint, and the standard short studs of the joint are replaced by longer threaded rods in the field. Threaded rods, of course, can also be cut to suit in the field. Similar effect can also be accomplished utilizing standard fabricated, stuffing-box couplings and similarly modified "Coupling Gland Ends" (see pg 9-36). Contact AMERICAN for additional information on this.

Assembly Instructions

1. Assemble the Mechanical Joint according to standard MJ joint procedures with the pipe and/or fitting in essentially straight alignment. Note that the bolts for this joint are not standard length; special-length bolts are furnished for this joint by AMERICAN. Where tapped holes are encountered in fittings or in valves, use studs of the same special length as specified for the THHN Bolts.

2. Thread the coupling nuts onto the tee-head bolts and hand tighten against the hex nuts.** Install short, threaded end of studs into the coupling nuts.

3. Slide the gland into position and install outer hex nuts. (Note: If deflection is desired, it should be taken at this point prior to tightening the outer hex nuts.) Tighten to 20 ft-lb in order to draw gland substantially against welded-on ring on pipe. Joint is now complete.

** In 20" and 24" sizes only, the coupling nut is to be positioned not against the hex nut, but rather so that there is a minimum of 3/4" thread engagement with both the tee-head as well as stud threads.



**AMERICAN Ductile Iron
MJ Coupled Joint**

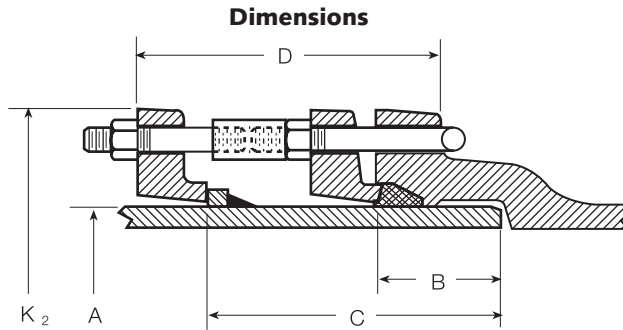

Table No. 9-13

4"-24"

| Size in. | A Outside Diameter in. | B Socket Depth in. | C Plain End to Gland in. | K ₂ Gland O.D. in. | Bolts or Studs No. | Tee-Head Bolt in. | Stud in. | MJCJE & MJCJE Minimum Laying Length (ft.) |
|----------|------------------------|--------------------|--------------------------|-------------------------------|--------------------|-------------------|-------------|---|
| 4 | 4.80 | 2.50 | 6.34 | 9.12 | 4 | 3/4 x 4 | 3/4 x 3 1/2 | 2'-3" |
| 6 | 6.90 | 2.50 | 6.50 | 11.12 | 6 | 3/4 x 4 | 3/4 x 3 1/2 | 2'-3" |
| 8 | 9.05 | 2.50 | 6.64 | 13.37 | 6 | 3/4 x 4 1/2 | 3/4 x 3 1/2 | 2'-3" |
| 10 | 11.10 | 2.50 | 6.71 | 15.69 | 8 | 3/4 x 4 1/2 | 3/4 x 3 1/2 | 2'-3" |
| 12 | 13.20 | 2.50 | 6.77 | 17.94 | 8 | 3/4 x 4 1/2 | 3/4 x 3 1/2 | 2'-3" |
| 14 | 15.30 | 3.50 | 8.88 | 20.31 | 10 | 3/4 x 5 | 3/4 x 5 | 2'-9" |
| 16 | 17.40 | 3.50 | 8.88 | 22.56 | 12 | 3/4 x 5 | 3/4 x 5 | 2'-9" |
| 18 | 19.50 | 3.50 | 8.88 | 24.83 | 12 | 3/4 x 5 | 3/4 x 5 | 3'-0" |
| 20 | 21.60 | 3.50 | 8.88 | 27.08 | 14 | 3/4 x 6 | 3/4 x 5 | 3'-0" |
| 24 | 25.80 | 3.50 | 8.88 | 31.58 | 16 | 3/4 x 6 | 3/4 x 5 | 3'-0" |

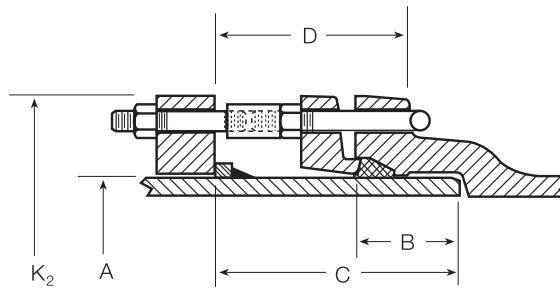

Table No. 9-14

30"-48"

| Size in. | A Outside Diameter in. | B Socket Depth in. | C Plain End to Gland in. | K ₂ Gland O.D. in. | Bolts or Studs No. | Tee-Head Bolt in. | Stud in. | MJCJE & MJCJE Minimum Laying Length (ft.) |
|----------|------------------------|--------------------|--------------------------|-------------------------------|--------------------|-------------------|-----------|---|
| 30 | 32.00 | 4.00 | 10.88 | 39.12 | 20 | 1 x 7 | 1 x 6 | 3'-6" |
| 36 | 38.30 | 4.00 | 10.88 | 46.00 | 24 | 1 x 7 | 1 x 6 | 3'-6" |
| 42 | 44.50 | 4.00 | 11.63 | 53.12 | 28 | 1 1/4 x 7 | 1 1/4 x 7 | 4'-0" |
| 48 | 50.80 | 4.00 | 11.63 | 60.00 | 32 | 1 1/4 x 7 | 1 1/4 x 7 | 4'-0" |



AMERICAN Joints - Restrained Coupling Gland Joint

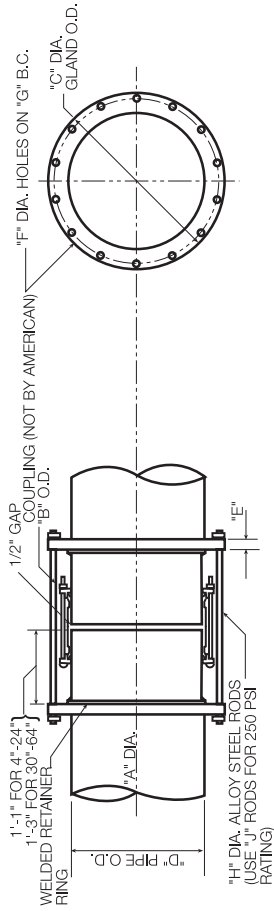

Table No. 9-15

| A in. | B Maximum in. | C in. | D Pipe O.D. in. | E in. | F B.H. Dia. in. | G B.C. in. | H Tie Rod ϕ in. | J No. Rods | Tie Rod Length in. |
|-------|---------------|-------|-----------------|-------|-----------------|------------|----------------------|------------|--------------------|
| 4 | 9.00 | 11.50 | 4.80 | 1.00 | 7/8 | 9.88 | 3/4 | 4 | 31 1/2 |
| 6 | 11.00 | 13.50 | 6.90 | 1.00 | 7/8 | 11.88 | 3/4 | 4 | 31 1/2 |
| 8 | 13.06 | 15.63 | 9.05 | 1.00 | 7/8 | 13.94 | 3/4 | 4 | 31 1/2 |
| 10 | 15.81 | 18.37 | 11.10 | 1.00 | 7/8 | 16.69 | 3/4 | 4 | 31 1/2 |
| 12 | 18.06 | 20.63 | 13.20 | 1.00 | 7/8 | 18.94 | 3/4 | 6 | 31 1/2 |
| 14 | 19.31 | 23.00 | 15.30 | 1.50 | 7/8 | 21.32 | 3/4 | 0 | 31 1/2 |
| 16 | 21.38 | 24.63 | 17.40 | 2.00 | 7/8 | 23.01 | 3/4 | 2 | 31 1/2 |
| 18 | 23.50 | 27.00 | 19.50 | 2.00 | 7/8 | 25.38 | 3/4 | 2 | 31 1/2 |
| 20 | 25.63 | 29.13 | 21.60 | 2.00 | 7/8 | 27.51 | 3/4 | 14 | 31 1/2 |
| 24 | 29.19 | 33.38 | 25.80 | 2.00 | 7/8 | 31.69 | 3/4 | 16 | 31 1/2 |
| 30 | 37.00 | 40.11 | 32.00 | 2.25 | 1 1/8 | 38.25 | 1 | 20 | 39 1/2 |
| 36 | 43.31 | 46.30 | 38.30 | 2.44 | 1 1/8 | 44.56 | 1 | 24 | 39 1/2 |
| 42 | 49.50 | 53.12 | 44.50 | 2.62 | 1 3/8 | 51.00 | 1 1/4 | 28 | 41 1/2 |
| 48 | 55.81 | 60.00 | 50.80 | 2.81 | 1 3/8 | 57.50 | 1 1/4 | 32 | 41 1/2 |
| 54 | 62.57 | 66.88 | 57.56 | 3.00 | 1 3/8 | 64.38 | 1 1/4 | 36 | 41 1/2 |
| 60 | 66.41 | 73.00 | 61.61 | 3.12 | 1 3/4 | 69.25 | 1 1/2 | 26 | 42 |
| 64 | 70.47 | 80.00 | 65.67 | 3.38 | 1 3/4 | 76.00 | 1 1/2 | 26 | 42 |

*If limited flexibility or expansion/contraction capabilities are important in the application, Coupling gland ends (CGE) are provided as a method of restraining across couplings. Restraining glands can be furnished of steel or ductile iron at manufacturer's option. Alloy steel rods are furnished and the number of rods furnished for each pipe size allows the joint to be rated at 250 psi water working pressure.

The joint is designed to allow "drop-in" installation. This means that, based on popular short coupling lengths, the coupling will normally clear the end of the pipe if it is pushed all of the way to the gland on that piece of pipe. Note: AMERICAN does not furnish the couplings used with this joint; therefore, the user should check coupling pressure rating, length, and diameter dimensions used for appropriate clearances to make sure they are compatible with the joint before ordering.



Thrust Collars

One method of restraining a pipeline is to provide a welded-on thrust collar or other dependable anchorage means on one or both sides of the point requiring restraint and to use concrete poured around the collar for support against undisturbed soil surrounding the pipe.

At a bend, the fitting and pipe ends would have to be of a restrained type, adequate to withstand total thrust involved. The required number of thrust collars would be dependent on the mag-

nitude of the thrust force to be restrained and the allowable load per collar.

Thrust collars are also used in lieu of water stops on fabricated wall pipe for installation in load-bearing walls to resist thrust caused by internal pressure.

The allowable load per standard collar for the various sizes of pipe is tabulated below.

Contact AMERICAN when greater loads are involved.

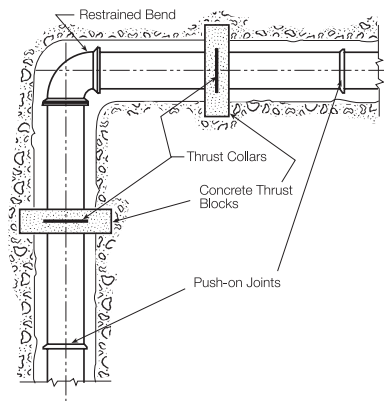

Table No. 9-16 **Thrust Collar Blocking Arrangement**

| Pipe Size in. | Collar O.D. * in. | Collar Thickness* in. | Weight of Collar* lbs | Allowable Load Per Collar** lbs |
|------------------|-------------------------|-----------------------------|-----------------------------|--|
| 4 | 6.80 | .25 | 1 | 4,500 |
| 6 | 8.90 | .25 | 2 | 9,300 |
| 8 | 11.05 | .25 | 2 | 16,000 |
| 10 | 13.10 | .25 | 3 | 24,000 |
| 12 | 15.20 | .25 | 3 | 34,000 |
| 14 | 17.30 | .25 | 5 | 46,000 |
| 16 | 19.40 | .25 | 6 | 59,000 |
| 18 | 22.50 | .38 | 15 | 75,000 |
| 20 | 24.60 | .38 | 11 | 92,000 |
| 24 | 28.80 | .38 | 13 | 130,000 |
| 30 | 36.00 | .50 | 29 | 200,000 |
| 36 | 42.30 | .50 | 35 | 290,000 |
| 42 | 50.75 | .75 | 98 | 390,000 |
| 48 | 57.05 | .75 | 111 | 510,000 |
| 54 | 66.06 | 1.00 | 231 | 650,000 |
| 60 | 70.11 | 1.00 | 246 | 745,000 |
| 64 | 74.17 | 1.00 | 261 | 847,000 |

*Dimensions and weights of thrust collars furnished by AMERICAN but manufactured by others may vary from those shown in Table 9-11.

**These values are based on dead-end thrust due to 250 psi internal pressure. For higher allowable loads or pressures, check AMERICAN.

Thrust collars may be specified on ductile iron pipe with minimum pressure classes.

Thrust collars will be fabricated from steel.



AMERICAN Restrained Ductile Iron Pipe Joints

Field Welding Instructions

In most instances, careful planning and/or measuring ahead to position required field cuts in unrestrained sections of a pipeline can eliminate the need for any field-fabricated restrained joints. Also, it is generally and technically preferable in most 4"-36" restrained joint areas to restrain field-cut joints where possible with Fast-Grip gaskets or Field Flex-Rings which do not require field welding. In some cases, however, unforeseen circumstances may make it impossible to plan ahead, and at such times AMERICAN offers the following procedure whereby ductile iron or alloy steel rings can be field welded onto the barrels of ductile iron pipe to be used in restrained joint applications. **All operations required for field welding should never begin until the area where the welding will be performed has been appropriately checked for any potentially hazard-**

ous conditions per standard industry practice and/or as required by local, state, OSHA or any other federal requirements.

When these procedures are followed by welders skilled in the art, strong, dependable restrained joints should be produced. **In presenting this procedure, AMERICAN Cast Iron Pipe Company assumes no responsibility for the performance of field-welded pipe joints or pipe systems.**

WELDING EQUIPMENT AND MATERIALS

Welds should be applied using a D.C. arc welder and appropriate welding electrodes or wire. Welding should be accomplished using reverse polarity and amperage ranges recommended by the electrode or wire manufacturer, with appropriate operator adjustment for the actual welding conditions on ductile iron pipe.

Suitable Pipe Diameters for Field Cuts and Restrained Joint Field Fabrication

Table No. 9-17

| Nominal Pipe Size in. | Min. Pipe Dia. in. | Max. Pipe Dia. in. | Min. Pipe Circumference in. | Max. Pipe Circumference in. |
|-----------------------|--------------------|--------------------|-----------------------------|-----------------------------|
| 4 | 4.74 | 4.86 | 14 ^{29/32} | 15 ^{9/32} |
| 6 | 6.84 | 6.96 | 21 ^{1/2} | 21 ^{7/8} |
| 8 | 8.99 | 9.11 | 28 ^{1/4} | 28 ^{5/8} |
| 10 | 11.04 | 11.17 | 34 ^{11/16} | 35 ^{9/32} |
| 12 | 13.14 | 13.26 | 41 ^{9/32} | 41 ^{21/32} |
| 14 | 15.22 | 15.35 | 47 ^{13/16} | 48 ^{7/32} |
| 16 | 17.32 | 17.45 | 54 ^{13/32} | 54 ^{13/16} |
| 18 | 19.42 | 19.55 | 61 | 61 ^{13/32} |
| 20 | 21.52 | 21.65 | 67 ^{19/32} | 68 |
| 24 | 25.72 | 25.85 | 80 ^{13/16} | 81 ^{7/32} |
| 30 | 31.94 | 32.08 | 100 ^{11/32} | 100 ^{25/32} |
| 36 | 38.24 | 38.38 | 120 ^{1/8} | 120 ^{9/16} |
| 42 | 44.44 | 44.58 | 139 ^{5/8} | 140 ^{1/16} |
| 48 | 50.74 | 50.88 | 159 ^{13/32} | 159 ^{27/32} |
| 54 | 57.46 | 57.60 | 180 ^{17/32} | 180 ^{31/32} |
| 60 | 61.51 | 61.65 | 193 ^{1/4} | 193 ^{11/16} |
| 64 | 65.57 | 65.71 | 206 | 206 ^{7/16} |

Above table based on ANSI/AWWA C151/A21.51 guidelines for push-on joints. *54" dimensions based on nominal O.D. of 57.56". If existing 57.10" O.D. pipe is being field-fabricated, dimensions must be adjusted accordingly and proper ring material must be used. Check AMERICAN for details.

Caution should be taken when taking on any field pipe modification or repair operations, etc., that might involve or include an ignition source, (i.e., grinding, cutting or welding, etc., on pipe fittings or valves). All applicable safety codes, precautions and procedures should be followed; including making sure the work atmosphere is safe for such operation.



AMERICAN Restrained Ductile Iron Pipe Joints

Field Welding Instructions—Continued

The weld electrodes or wire used to deposit the required amount of fillet weld should be in conformance with Class designations AWS A5.15 Class ENiFeT3-CI, or AWS A5.6 (ASME SFA 5.6) Class Cu A1-A2. These electrodes shall be capable of producing suitable welds without preheating or postheating of the pipe and ring. A recommended semi-automatic welding wire, with appropriate weld specifications, is as follows:

Stoody® Castweld Ni 55-0/S/G, 3/32" diameter, D.C., reverse polarity (electrode positive), 325-400 amps.

PROCEDURE USING WELDING FIXTURES AND HAND-HELD ELECTRODES

This procedure is intended to be used for manual welding. Contact AMERICAN when semi-automatic welding setups are desirable.

1. Measure the candidate pipe diameter (or circumference) at the desired location of the cut to confirm the dimensions. The allowable pipe diameter and circumference should fall in the ranges as shown in Table 9-12. Any cut pipe with substantial out-of-roundness should be temporarily rounded with a mechanical jack and shaped timbers, then braced in the rounded shape for this field welding procedure. The rounding timber or brace should normally be left in place inside the pipe until after complete joint assembly in the field, at which time it should be removed for service.

2. Cut the pipe at the desired location and bevel the cut end for joint assembly. (See

Section 3.) It is imperative that field cuts for restrained joint welding be smooth, regular, and as square as possible with the axis of the pipe, inasmuch as the cut end is usually used as a reference plane to position the welded rings from the end of the pipe.

3. Clean and grind the weld location on the pipe to bright metal (Photo 1) prior to positioning the ring. Asphaltic coating in the weld area should be removed with a torch or with a solvent wash prior to grinding. Also, the corresponding edge of the ring to be welded should be cleaned and ground to bright metal. Loose locking rings or glands (if required for the particular joint configuration) should be placed on the pipe beyond the weld ring location at this point. (See illustrations on the next page and Photo 2.)



Fig. 9-1
Circular Welding Fixture

4. Clamp the joint weld ring securely on the pipe in the correct location. (See Table 9-13.) This may be accomplished using a special welding fixture (Photo 3). An example of a recommended ring welding fixture available from AMERICAN is shown in Figure 9-1. If clamping devices not furnished by AMERICAN are utilized for the ring-clamp operation, they should





AMERICAN Restrained Ductile Iron Pipe Joints

Field Welding Instructions—Continued

be capable of holding the ring securely in the proper position and straight on the pipe until all weld is applied.

NOTE: *If clamps are used, care should be taken to cushion the clamps where they bear on the inside of the pipe to minimize damage to the pipe lining. The cement linings routinely supplied by AMERICAN are normally not adversely affected by the welding procedures described in this brochure. If significant cement lining damage occurs due to any cause, it should be patched in accordance with recommended procedures as noted in Section 11. Contact AMERICAN for requirements involving field welding of pipes with special linings.*

5. Weld the ring to the pipe with the final weld dimensions as shown in Table 9-13. Appropriate flat or down-hand techniques for field welding ductile iron should be used. In manual electrode welding, pipe welding rotators or rolling the pipe on timbers or rails is normally necessary to keep the work flat or “downhand.” For the same reason, field welding of restrained ends should generally not be done “in situ” (i.e., in the ditch, assembled), as the pipe cannot easily be rolled or rotated to keep the position “downhand.” The use of short, overlapping weld passes in manual welding will minimize heat buildup, cracking, and thermal stresses as the metal cools. Weld passes should be thoroughly cleaned (peened) and inspected before cooling and prior to the addition

of adjoining passes. Also, the ends of the adjoining passes should not coincide but should be slightly overlapped before the arc is broken. The resulting weld fillet should be of a slightly convex shape and free of significant weld defects. Weld cracks, if they occur, should be ground away and repaired with a weld overlay.

When a recommended welding fixture is utilized (Photo 4), start the weld at one end of the ring and work continuously and progressively through the other end.

After the entire ring has been field welded to the pipe, weld the ring ends to the pipe and weld in the small space remaining between the ring ends to ensure proper weld height at the ring ends.

6. Wire brush the weld and ring to remove all slag or weld spatter (Photo 5). Particular care must be taken to brush or chip away any weld spatter which may have accumulated on the pipe spigot which could interfere with proper gasket sealing or joint assembly. Any significant weld bead lumps or irregularities which might interfere with proper joint assembly or performance should also be removed.

7. Paint the ring, weld, and clean pipe metal area (Photo 6) with a smooth uniform coat of asphaltic paint or mastic which meets the requirements for ductile iron pipe outside coating per ANSI/AWWA C151/A21.51.





AMERICAN Restrained Ductile Iron Pipe Joints

Field Welding of Restrained Joints

MJ Coupled Joint

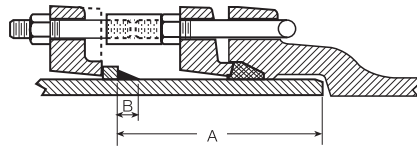

**Flex-Ring® Joint
4"-12"**

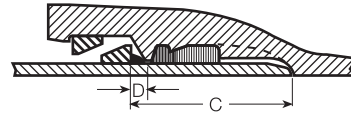

Note: Sizes 30"-48" use rectangular crosssection spigot glands in lieu of ductile MJ gland shown above.

**Flex-Ring® Joint
14"-48"**

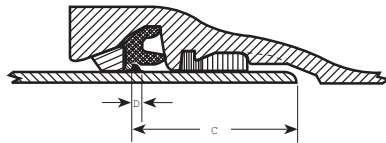

Lok-Ring® Joint

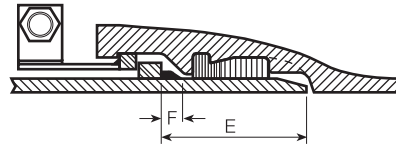

Note: Contact AMERICAN for applications involving field welding of 14"-48" Flex-Ring Joint.*

Table No. 9-18

Dimensions

| Size in. | MJ Coupled Joint | | | | Flex-Ring Joint | | | | Lok-Ring Joint | | | |
|-------------|-------------------------------------|-------------------------------------|------------------------|------------------------|-------------------------------------|---------------------------------------|---|------------------------|-------------------------------------|-------------------------------------|------------------------|------------------------|
| | A ± ¹ / ₁₆ | B ± ¹ / ₁₆ | Weld Height Min. | Weld Weight lbs. | C ± ¹ / ₁₆ | D ⁺³ / ₁₆ -0 | Weld Height ⁺¹ / ₈ -0 | Weld Weight lbs. | E ± ¹ / ₁₆ | F ± ¹ / ₁₆ | Weld Height Min. | Weld Weight lbs. |
| 4 | 5.84 | .50 | .20 | .4 | 3.80 | .25 | .19 | .1 | - | - | - | - |
| 6 | 6.00 | .50 | .20 | .3 | 3.80 | .25 | .19 | .2 | - | - | - | - |
| 8 | 6.14 | .50 | .20 | .6 | 3.92 | .25 | .19 | .2 | - | - | - | - |
| 10 | 6.21 | .50 | .20 | .7 | 4.50 | .25 | .19 | .3 | - | - | - | - |
| 12 | 6.27 | .50 | .20 | .8 | 4.50 | .25 | .19 | .4 | - | - | - | - |
| 14 | 8.38 | .50 | .20 | .9 | 4.63 | .25 | - | - | - | - | - | - |
| 16 | 8.38 | .50 | .20 | 1.0 | 4.63 | .25 | - | - | - | - | - | - |
| 18 | 8.38 | .50 | .20 | 1.1 | 5.25 | .25 | - | - | - | - | - | - |
| 20 | 8.38 | .50 | .20 | 1.2 | 5.25 | .25 | - | - | - | - | - | - |
| 24 | 8.38 | .50 | .20 | 1.3 | 5.38 | .37 | - | - | - | - | - | - |
| 30 | 10.38 | .75 | .25 | 2.8 | 6.00 | .50 | - | - | - | - | - | - |
| 36 | 10.38 | .75 | .25 | 3.4 | 6.00 | .50 | - | - | - | - | - | - |
| 42 | 11.13 | .75 | .25 | 3.9 | 6.07 | .50 | - | - | - | - | - | - |
| 48 | 11.13 | .75 | .25 | 4.5 | 7.38 | .50 | - | - | - | - | - | - |
| 54 | - | - | - | - | - | - | - | - | 6.38 | .88 | .30 | 4.5 |
| 60 | - | - | - | - | - | - | - | - | 6.38 | .88 | .30 | 4.9 |
| 64 | - | - | - | - | - | - | - | - | 6.38 | .88 | .30 | 5.3 |

Contact AMERICAN for alternative field welding considerations for 14"-48" Flex-Ring pipes. Dimensions are in inches.

Note: Dimensions shown are for current AMERICAN products and are subject to change. Check AMERICAN for field welding applications for connecting to existing piping.

Note: For alternative preferred method of restraining field-cut ends in most 4"-30" Flex-Ring Joint Systems, see pg. 9-2 "Fast-Grip® Gasket."

*Note: Field Flex-Rings are normally recommended in lieu of field welding for restraining field-cut ends in 14"-36" Flex-Ring Joint Systems, see pg. 9-21 "Field Flex-Ring®."



Restrained Joint Pipe Assembly Extension Procedure



In some installations of restrained joint pipe, it is desirable to pull-extend (or take the "slack" or movement out of) installed restrained joints. In traditional backhoe or bulldozer push-on pipe assembly, it is most common for the installer to push-assemble the latest installed pipe into the line. In applications where restrained joints are to be extended, however, and particularly in some exposed lines, the pushing operation can unnecessarily disturb previously extended joints. In such cases, some very simply designed rigging (using the same heavy equipment) can ensure that only pulling loads are applied to previously extended joints as new joints are assembled. One such rigging method, utilizing a snatch block (with pulley and hook), a wire rope pulling cable, and a pipe end hook is illustrated in the above photograph. Of course, a simple wire rope "choker cable" can be substituted for the chain around the pipe bell shown in the above photograph.

Note: Care should be taken in such operations at connections of restrained piping to unrestrained piping. One should securely anchor the first restrained pipe in-

stalled, so as not to unintentionally separate the last unrestrained (Fastite or MJ, etc.) joint installed. Also, care should be exercised to avoid damaging pipe (as by beam loading to branch lines or laterals, etc.) in pulling operations.

AMERICAN manufactures 4" through 12" Mechanical Joint Ductile Iron pipe in accordance with AWWA C151 and AWWA C111 and Mechanical Joint fittings up through 48" in accordance with AWWA C153, AWWA C110, and AWWA C111, as described therein. However, AMERICAN does not warrant the performance of third-party mechanical retainer glands or joints using third-party retainer glands, since the design, manufacturing, and installation methods are beyond our control. Furthermore, we do not recommend the use of retainer glands on minimum classes of ductile iron pipe. AMERICAN does manufacture a number of restrained joints such as Fast-Grip[®], Flex-Ring[®], Field Flex-Ring[®], Lok-Ring[®], Flex-Lok[®], and other devices, where we warrant the joint as well as the associated pipe and fittings of our manufacture.

Section 10

AMERICAN Ball Joint Pipe





AMERICAN Flex-Lok® Ball Joint Pipe for Water and Other Liquids

AMERICAN ball joint piping complies with requirements of ANSI/AWWA C151/A21.51 and ANSI/AWWA C153, which are applicable to its manufacture. These and other standards are referenced throughout this Section either by the full ANSI/AWWA designation or by only the AWWA numbering, such as AWWA C151.

AMERICAN Flex-Lok® Pipe incorporates a very flexible ball-and-socket type joint for use in such installations as subaqueous pipeline construction. The provision for significant changes in alignment through substantial deflection and the rugged features of AMERICAN Flex-Lok Pipe make it especially

adaptable to the most difficult installations. This rugged joint configuration has an excellent record of performance and, under some of the toughest installation conditions, it has provided long life and trouble-free service. Economy and dependability have also been proven under widely varying conditions.

Typical Applications for AMERICAN Flex-Lok®

River Crossings

Where deep water and strong currents are encountered, as in unstable channels and under flood stage conditions. Where deep trenches, steep banks and other difficult approaches require special construction considerations.

Busy Waterways

Where installation time and maneuverability are critical factors.

Tidal Waters

Where changing currents and water depths are encountered, and where the line is subject to movement.

River Intakes

Where it is necessary to have a flexible intake, the level of which may be adjusted with changing water levels.

Swamps and Floodlands

Where water and earth are subject to seasonal variations, or where the underground line must give with the

sub-surface movements caused by temperature change, moisture content or other factors.

Hillsides

Where steep grades are encountered, where trenching and backfilling are impossible, or where the line may have unstable bedding.

Seismic Environments

Where significant ground movements due to earthquakes are anticipated, particularly suited for piping outside structures where differential settlement can occur.

Difficult and Inaccessible Locations

Where trenching is impossible, working conditions are hazardous, service cannot be interrupted, or lines are inaccessible for maintenance or repair. All scenarios requiring a combination of significant joint deflection and positive joint restraint.



AMERICAN Ductile Iron Flex-Lok® Ball Joint Pipe

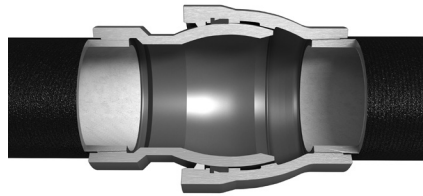

AMERICAN Flex-Lok® Pipe incorporates a very flexible ball-and-socket type joint for use in such installations as subaqueous pipeline construction. The provision for significant changes in alignment, with available joint deflections of 25° for sizes 4"-12" and at least 15° for sizes 14"-60" in any direction, and the rugged features of AMERICAN Flex-Lok Pipe make it especially adaptable to the most difficult installations. This rugged joint configuration has an excellent record of performance, and under some of the toughest installation conditions, it has provided long life and trouble-free service. Economy and dependability have been proven in many installations under widely varying conditions.

AMERICAN Flex-Lok Boltless Ball Joint Pipe — manufactured in 4"-60"¹ sizes² — is a rugged, boltless, flexible joint pipe designed and manufactured to assure the greatest economy in installation with maximum performance and reliability. This ductile iron pipe meets all applicable requirements of AWWA C151 and is designed to withstand severe installation and service conditions encountered in river crossings, treated wastewater outfall lines, water supply intakes, swamps, floodlands and rugged terrain where significant joint deflection may be required.

AMERICAN Flex-Lok Boltless Ball Joint Pipe provides variable deflection up to at least 15°, and the joint may be deflected to metal binding position at maximum deflection

without harm to the pipe or joint components. This is a result of the unique design and functionality of the pipe and joint components. In sizes 4"-12", the configuration incorporates the additional flexible restraint provided by AMERICAN's Flex-Ring joint, which cumulatively results in greater joint deflection capabilities, up to 25°.

Spherical Socket

The spherical socket of the AMERICAN Flex-Lok joint is cast of ductile iron and is accurately machined to accommodate the ball of the adjoining pipe. The thick wall and bell section provides superior strength to minimize the stresses resulting from installation and service conditions.

The Flex-Lok joint gasket recess in the socket is designed and manufactured to provide easy insertion and positive seating of the gasket to avoid displacement during assembly and for constant compression of the gasket through the entire range of deflection of the assembled joint.

Spherical Ball

The ball end of the AMERICAN Flex-Lok joint is accurately machined to fit into the adjoining pipe socket and to provide constant compression of the gasket through the entire range of deflection of the assembled joint.

The inside surface of the ball is shaped so that the waterway will not be significantly obstructed at any angle of joint deflection.



Flex-Lok Gasket

The AMERICAN Flex-Lok joint uses the basic dual hardness gasket design of the AMERICAN Fastite joint that has been proven with millions of joints over approximately 65 years. Designed to provide maximum sealability, the Flex-Lok gasket is manufactured to AMERICAN's rigid specification to assure controlled dimensional and material properties.

The snug fit of the gasket in the socket cavity, the design of the socket buttress and the hard section of the gasket act to restrain the gasket from dislodging during assembly.

Locking Systems

Two types of locking systems are used to prevent longitudinal joint separation of the AMERICAN Flex-Lok joint, depending on pipe size. In the 4"-20" sizes, the locking system employs a substantial external locking ductile iron gland and sizes 4"-12" also use the proven positive joint restraint system of the Flex-Ring joint. Both the spherical socket component and spherical ball component of the Flex-Lok joint in this size range have a Flex-Ring joint that is preassembled at AMERICAN. For 24" - 60" sizes, the joint is restrained with a ductile iron retainer ring fitted into a mating groove inside the heavy-section bell.

4"-20" Flex-Lok Pipe Joint

The locking gland of the 4"-20" AMERICAN Flex-Lok joint is cast of ductile iron. The gland has internal lugs that interlock with external lugs on the bell.

The lugs on the gland are passed between and beyond the lugs on the bell periphery, and the gland is then rotated to lock the joint and prevent separation.

All 4"-20" AMERICAN Flex-Lok Ball Joint Pipe is prepared for shipment to the job site with the locking gland strapped to the ball. These straps must be removed to free the gland for assembly. The 4"-12" configuration has a preassembled Flex-Ring joint both directly adjacent to the spherical socket and spherical ball. The locking gland is also shipped strapped to the ball.

A steel wedge with a welded-on threaded stud is provided for each 4"-20" AMERICAN Flex-Lok joint. One wedge is placed into the space between two lugs and bolted into position. This wedge provides a positive lock to prevent gland rotation after assembly.

24"-60" Flex-Lok Pipe Joint

A split retainer ring manufactured of ductile iron is fitted into a mating groove inside the heavy bell section, providing restraint against longitudinal joint separation in the 24"-60" sizes. This ring is shipped strapped to the ball. These straps must be removed to free the ring for assembly. After the ring is fitted into the groove inside the bell, a locking clip, held in place by a stainless steel spring, is inserted into the space between the ends of the ring to securely lock it into the groove.

Joint Lubricant

Special AMERICAN Joint Lubricant for underwater installation is furnished with each order to provide ample lubrication for assembly and joint flexing. This special lubricant is different from regular Fastite lubricant and is insoluble, non-toxic, will impart no taste or odor to the conveyed liquid and will not have a deleterious effect on the rubber gasket.

AMERICAN Flex-Lok Ball Joint Pipe is centrifugally cast in laying lengths shown under Standard Dimensions with the same standard outside diameters as AMERICAN Fastite or Mechanical Joint Pipe, thus simplifying tie-in connections by allowing the use of standard fittings.

AMERICAN Flex-Lok Ball Joint Pipe may be furnished with any of the coatings and linings described in Section 11. Unless otherwise specified, the pipe is normally furnished with an asphaltic coating on the exterior and with the interior cement lined per AWWA C104.

1.) Contact AMERICAN for 64" requirements.

2.) The spherical ball and socket ends of 54" and 60" Flex-Lok pipes are fastened to the barrels of the pipe with a Fastite gasket and locking ring arrangement instead of threads.



AMERICAN DUCTILE IRON PIPE

AMERICAN Ductile Iron Flex-Lok Boltless Ball Joint Pipe For Water, Sewage and Other Liquids

STANDARD DIMENSIONS 4"-12"

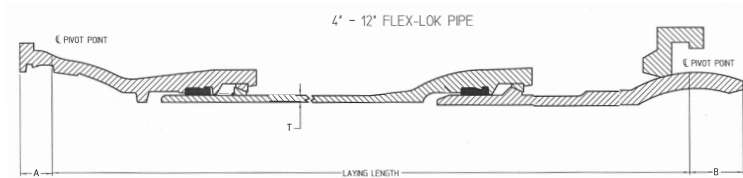

| Size in. | Laying Length ¹ ft./in. | Working Pressure ² psi | T Wall Thickness ³ in. | Nominal Weight in Pounds | | | Nominal Underwater Weight Per Length Incl. Joint Materials ⁴ | |
|----------|------------------------------------|-----------------------------------|-----------------------------------|--------------------------|----------------------------------|--------------------------------|---|-------------------|
| | | | | Per Pipe Length | Per Length Incl. Joint Materials | Per Foot Incl. Joint Materials | Full of Air lb. | Full of Water lb. |
| 4 | 21'-6" | 250 | .41 | 450 | 480 | 22.3 | 311 | 427 |
| 6 | 21'-7" | 250 | .43 | 680 | 720 | 33.4 | 370 | 638 |
| 8 | 21'-8" | 250 | .45 | 945 | 1000 | 46.2 | 396 | 886 |
| 10 | 21'-7-5/8" | 250 | .47 | 1265 | 1325 | 61.2 | 418 | 1178 |
| 12 | 21'-8-5/8" | 250 | .49 | 1565 | 1665 | 76.7 | 377 | 1481 |

14" & 18"

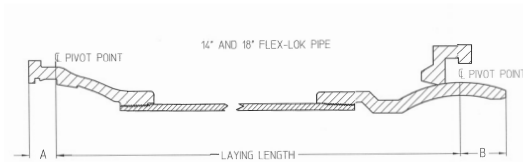

| Size in. | Laying Length ¹ ft./in. | Working Pressure ² psi | T Wall Thickness ³ in. | Nominal Weight in Pounds | | | Nominal Underwater Weight Per Length Incl. Joint Materials ⁴ | |
|----------|------------------------------------|-----------------------------------|-----------------------------------|--------------------------|----------------------------------|--------------------------------|---|-------------------|
| | | | | Per Pipe Length | Per Length Incl. Joint Materials | Per Foot Incl. Joint Materials | Full of Air lb. | Full of Water lb. |
| 14 | 20'-6" | 250 | .51 | 1760 | 1880 | 91.7 | 193 | 1615 |
| 18 | 20'-6" | 250 | .53 ⁵ | 2425 | 2610 | 127.3 | -129 ⁵ | 2245 |

16" & 20"

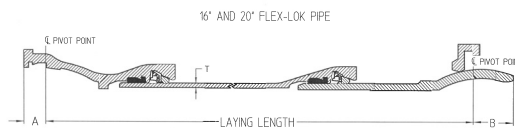

| Size in. | Laying Length ¹ ft./in. | Working Pressure ² psi | T Wall Thickness ³ in. | Nominal Weight in Pounds | | | Nominal Underwater Weight Per Length Incl. Joint Materials ⁴ | |
|----------|------------------------------------|-----------------------------------|-----------------------------------|--------------------------|----------------------------------|--------------------------------|---|-------------------|
| | | | | Per Pipe Length | Per Length Incl. Joint Materials | Per Foot Incl. Joint Materials | Full of Air lb. | Full of Water lb. |
| 16 | 22'-1" | 250 | .52 | 2560 | 2719 | 124 | 337 | 2335 |
| 20 | 22'-3" | 250 | .54 | 3445 | 3681 | 166 | 77 | 3160 |



**AMERICAN Ductile Iron Flex-Lok Boltless Ball Joint Pipe
For Water, Sewage and Other Liquids**

24"- 48"

24" - 36" FLEX-LOK PIPE

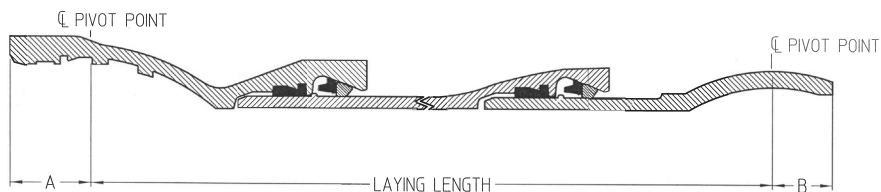

| Size in. | Laying Length ¹ ft./in. | Working Pressure ² psi | T Wall Thickness ³ in. | Nominal Weight in Pounds | | | Nominal Underwater Weight Per Length Incl. Joint Materials ⁴ | |
|----------|------------------------------------|-----------------------------------|-----------------------------------|--------------------------|----------------------------------|--------------------------------|---|-------------------|
| | | | | Per Pipe Length | Per Length Incl. Joint Materials | Per Foot Incl. Joint Materials | Full of Air lb. | Full of Water lb. |
| 24 | 22'-7" | 250 | .56 ⁵ | 4557 | 4636 | 206 | -704 ⁵ | 3960 |
| 30 | 22'-4-5/8" | 250 | .63 | 6666 | 6749 | 302 | -1862 | 5252 |
| 36 | 22'-11-5/16" | 250 | .73 | 9675 | 9787 | 426 | -2943 | 7934 |
| 42 | 24'-2-5/16" | 250 | .83 | 13871 | 13934 | 596.1 | -4661 | 10190 |
| 48 | 23'-6-1/4" | 250 | .93 | 17347 | 17435 | 717 | -7785 | 11931 |

54"- 60"

54" AND 60" FLEX-LOK PIPE

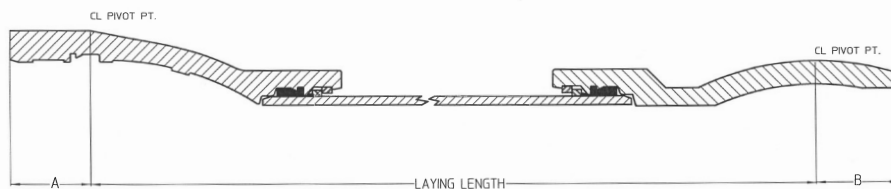

| Size in. | Laying Length ¹ ft./in. | Working Pressure ² psi | T Wall Thickness ³ in. | Nominal Weight in Pounds | | | Nominal Underwater Weight Per Length Incl. Joint Materials ⁴ | |
|----------|------------------------------------|-----------------------------------|-----------------------------------|--------------------------|----------------------------------|--------------------------------|---|-------------------|
| | | | | Per Pipe Length | Per Length Incl. Joint Materials | Per Foot Incl. Joint Materials | Full of Air lb. | Full of Water lb. |
| 54 | 23'-0" | 250 | 1.05 | 24000 | 24150 | 1050 | -3125 | 20950 |
| 60 | 23'-3" | 250 | .87 | 26650 | 26875 | 1156 | -5920 | 23410 |



**AMERICAN Ductile Iron Flex-Lok Boltless Ball Joint Pipe
For Water, Sewage and Other Liquids**

**TECHNICAL DATA
4" - 12"**

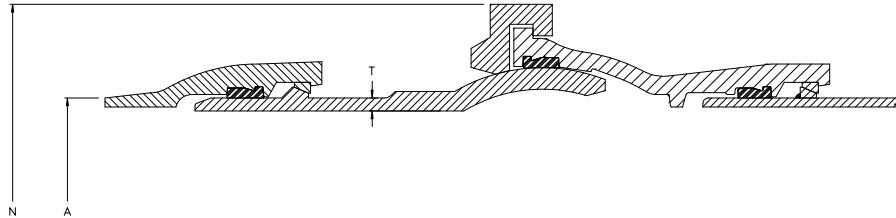

| Size in. | A in. | N in. | Joint Materials Weight/lb. | | | | Lubricant Pounds Per Joint | Maximum Joint Deflection ** | Maximum Safe End Pull in Tonst |
|----------|-------|-------|----------------------------|--------|---------------|--------------|----------------------------|-----------------------------|--------------------------------|
| | | | Gland | Gasket | Locking Wedge | Complete Set | | | |
| 4 | 4.80 | 11.79 | 27 | 1 | 1 | 29 | 0.09 | 25° | 21 |
| 6 | 6.90 | 13.91 | 37 | 1 | 1 | 0.12 | 0.12 | 25° | 35 |
| 8 | 9.05 | 16.38 | 50 | 1 | 2 | 0.16 | 0.16 | 25° | 49 |
| 10 | 11.10 | 18.84 | 67 | 1 | 3 | 0.27 | 0.27 | 25° | 63 |
| 12 | 13.20 | 21.56 | 89 | 1 | 3 | 0.40 | 0.40 | 25° | 76 |

14" & 18"

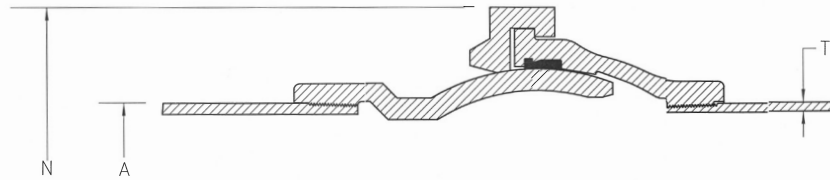

| Size in. | A in. | N in. | Joint Materials Weight/lb. | | | | Lubricant Pounds Per Joint | Maximum Joint Deflection ** | Maximum Safe End Pull in Tonst |
|----------|-------|-------|----------------------------|--------|---------------|--------------|----------------------------|-----------------------------|--------------------------------|
| | | | Gland | Gasket | Locking Wedge | Complete Set | | | |
| 14 | 15.30 | 24.43 | 115 | 2 | 3 | 120 | 0.50 | 15° | 90 |
| 18 | 19.50 | 29.70 | 181 | 3 | 4 | 188 | 0.75 | 15° | 110 |

16" & 20"

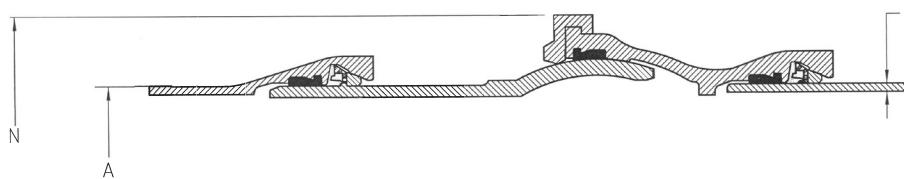

| Size in. | A in. | N in. | Joint Materials Weight/lb. | | | | Lubricant Pounds Per Joint | Maximum Joint Deflection ** | Maximum Safe End Pull in Tonst |
|----------|-------|-------|----------------------------|--------|---------------|--------------|----------------------------|-----------------------------|--------------------------------|
| | | | Gland | Gasket | Locking Wedge | Complete Set | | | |
| 16 | 17.40 | 26.78 | 140 | 3 | 4 | 147 | 0.60 | 22.5° | 100 |
| 20 | 21.60 | 32.59 | 210 | 4 | 4 | 218 | 0.90 | 22° | 119 |



**AMERICAN Ductile Iron Flex-Lok Boltless Ball Joint Pipe
For Water, Sewage and Other Liquids**

24"- 48"

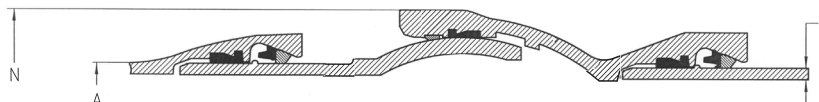

| Size in. | A in. | N in. | Joint Materials Weight/lb. | | | | Lubricant Pounds Per Joint | Maximum Joint Deflection ** | Maximum Safe End Pull in Tonst |
|----------|-------|-------|----------------------------|--------|-------------|--------------|----------------------------|-----------------------------|--------------------------------|
| | | | Retaining Ring | Gasket | Spring/Clip | Complete Set | | | |
| 24 | 25.80 | 33.82 | 14 | 5 | 1 | 20 | 1.10 | 21° | 130 |
| 30 | 32 | 40.57 | 17 | 6 | 1 | 24 | 1.06 | 20° | 225 |
| 36 | 38.3 | 48.43 | 35 | 8 | 1 | 44 | 2.02 | 19° | 255 |
| 42 | 44.50 | 57.48 | 53 | 10 | 1 | 64 | 2.7 | 19° | 305 |
| 48 | 50.8 | 64.45 | 77 | 10 | 1 | 88 | 3.5 | 19° | 350 |

54"- 60"

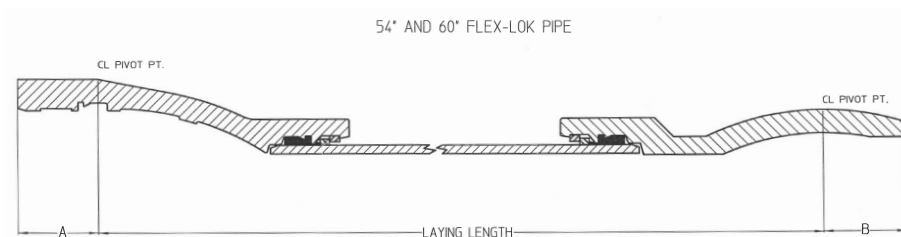

| Size in. | A in. | N in. | Joint Materials Weight/lb. | | | | Lubricant Pounds Per Joint | Maximum Joint Deflection ** | Maximum Safe End Pull in Tonst |
|----------|-------|-------|----------------------------|--------|---------------|--------------|----------------------------|-----------------------------|--------------------------------|
| | | | Gland | Gasket | Locking Wedge | Complete Set | | | |
| 54 | 57.56 | 73.37 | 121 | 22 | 2 | 145 | 4.7 | 15° | 450 |
| 60 | 61.61 | 80.13 | 198 | 27 | 3 | 228 | 10 | 15° | 500 |



AMERICAN DUCTILE IRON PIPE

**AMERICAN Ductile Iron Flex-Lok Boltless Ball Joint Pipe
For Water, Sewage and Other Liquids**

**LAYING LENGTHS
4"– 12"**

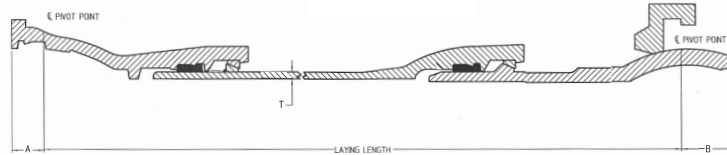

| Size in. | L.L. Maximum Laying Length* ft.-in. | O.L. Maximum Overall Length** ft.-in. | A in. | B in. | Bell Weight lb. | Ball Weight lb. |
|----------|-------------------------------------|---------------------------------------|-------|-------|-----------------|-----------------|
| 4 | 21'-6" | 21'-9 ¹ / ₄ " | 1.38 | 1.77 | 55 | 41 |
| 6 | 21'-7" | 21'-10 ¹ / ₄ " | 1.38 | 2.01 | 72 | 61 |
| 8 | 21'-8" | 21'-11 ³ / ₄ " | 1.42 | 2.34 | 99 | 88 |
| 10 | 21'-7-5/8" | 21'-11 ¹ / ₂ " | 1.42 | 2.61 | 143 | 123 |
| 12 | 21'-8-5/8" | 22'-1" | 1.42 | 2.91 | 184 | 169 |

14"– 18"

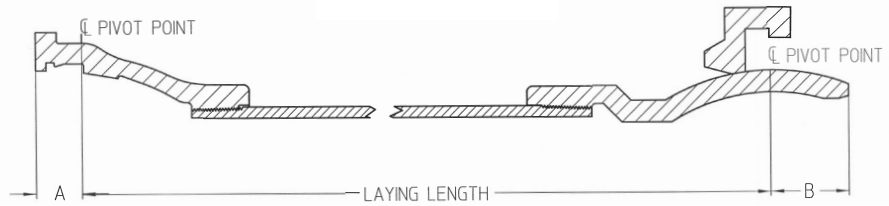

| Size in. | L.L. Maximum Laying Length* ft.-in. | O.L. Maximum Overall Length** ft.-in. | A in. | B in. | Bell Weight lb. | Ball Weight lb. |
|----------|-------------------------------------|---------------------------------------|-------|-------|-----------------|-----------------|
| 14 | 20'-6" | 20'-11 ³ / ₄ " | 1.73 | 3.32 | 177 | 183 |
| 18 | 20'-6" | 20'-11 ⁵ / ₈ " | 1.73 | 3.87 | 277 | 297 |

16"– 20"

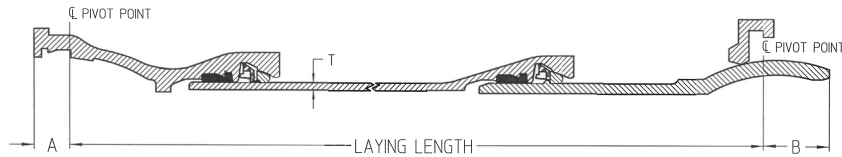

| Size in. | L.L. Maximum Laying Length* ft.-in. | O.L. Maximum Overall Length** ft.-in. | A in. | B in. | Bell Weight lb. | Ball Weight lb. |
|----------|--------------------------------------|---------------------------------------|-------|-------|-----------------|-----------------|
| 16 | 22'-1 ⁹ / ₁₆ " | 22'-6 ⁵ / ₈ " | 1.73 | 3.58 | 312 | 290 |
| 20 | 22'-3 ⁵ / ₁₆ " | 22'-9 ¹ / ₂ " | 2.01 | 4.16 | 505 | 420 |



**AMERICAN Ductile Iron Flex-Lok Boltless Ball Joint Pipe
For Water, Sewage and Other Liquids**

24"- 48"

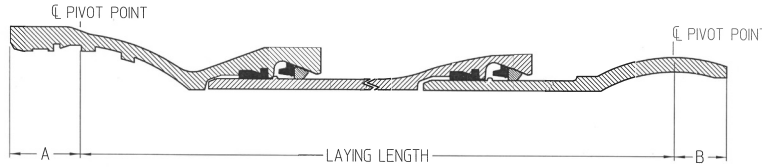

| Size in. | L.L. Maximum Laying Length* ft.-in. | O.L. Maximum Overall Length** ft.-in. | A in. | B in. | Bell Weight lb. | Ball Weight lb. |
|----------|-------------------------------------|---------------------------------------|-------|-------|-----------------|-----------------|
| 24 | 22'-7 1/8" | 23'-1 7/8" | 4.82 | 4.68 | 751 | 625 |
| 30 | 22'-4 5/8" | 22'-3 1/4" | 4.81 | 5.78 | 1320 | 1015 |
| 36 | 22'-11 15/16" | 24'-1/4" | 5.88 | 6.41 | 2100 | 1640 |
| 42 | 23'-4 1/2" | 24'-10 1/4" | 6.74 | 7.76 | 3292 | 2455 |
| 48 | 23'-6 1/4" | 24'-10 5/8" | 7.73 | 8.69 | 4412 | 2987 |

54"- 60"

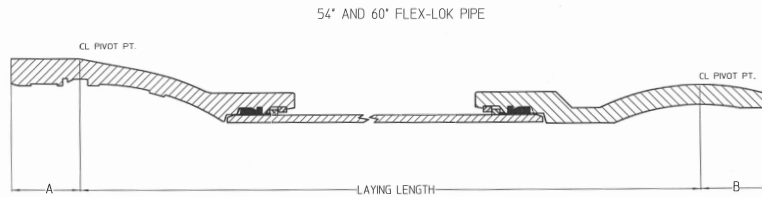

| Size in. | L.L. Maximum Laying Length* ft.-in. | O.L. Maximum Overall Length** ft.-in. | A in. | B in. | Bell Weight lb. | Ball Weight lb. |
|----------|-------------------------------------|---------------------------------------|-------|-------|-----------------|-----------------|
| 54 | 23'-0" | 24'-7 1/2" | 9.50 | 9.97 | 5875 | 5440 |
| 60 | 23'-3" | 25'-2 3/4" | 11.03 | 10.98 | 7852 | 9200 |

- 1.) The laying lengths in the above tables are subject to trim pipe allowance in accordance with AWWA C151. Also, this is the fully horned or inserted laying length of 4"-36" Flex-Lok Pipe. In installations where 4"-36" joints are pulled or extended to metal-binding contact of joint locking members, some slight additional laying length will be gained as a function of the removal of joint assembly space. Contact AMERICAN when lengths are critical, or when it is necessary to locate ball joints at specific stations, etc. The joints will seal properly in any axial position from fully horned to fully extended and with any joint deflection angles up to the maximum rating.
- 2.) The working pressure is AMERICAN's suggested standard water working pressure. Contact AMERICAN if higher working pressure is involved.
- 3.) Thicknesses correspond to Special Class 56. Check AMERICAN if pipe with other wall thickness is required.
- 4.) Does not include lining weight. Underwater pipe weights are for fresh water. Sea water is approximately 3% heavier than fresh water, and these weights should be adjusted accordingly for sea water installation.
- 5.) When full of air, pipe of this thickness will float unless weight is added. See Standard Cement Lining weights. Gross weight, including pipe, gland and lining, is painted on each length of Flex-Lok Pipe to aid in field calculations of actual buoyancy.
- 6.) Contact AMERICAN on requirements for 64" and larger Flex-Lok.
- 7.) Contact AMERICAN when lengths are critical, or when it is necessary to locate ball joints at specific stations, etc. The joints will seal properly in any axial position from fully horned to fully extended and with any joint deflection angles up to maximum rating when the joint is extended.
- 8.) Thicknesses correspond to Special Class 56 for 30"-54" sizes and Pressure Class 350 for the 60" size. Contact AMERICAN if pipe with other wall thickness is required.
- 9.) Contact AMERICAN for greater end pull requirements.
- 10.) The full deflection and laying length of 24"-60" joints is most readily obtained by fully extending the joints.
- 11.) The maximum laying length (and accordingly the maximum overall length) is subject to trim pipe allowance in accordance with AWWA C151. Also, this is the fully horned or inserted laying length of 4"-24" Flex-Lok pipe. In installations where 4"-24" joints are pulled or extended to metal-binding contact of joint locking members, some slight additional laying length will be gained as a function of the removal of joint assembly space. The joints will seal properly in any axial position from fully horned to fully extended and with any joint deflection angles up to the maximum rating.
- 12.) Overall Length (O.L.) equals Laying Length L.L. + A + B.



**AMERICAN Ductile Iron
Flex-Lok Boltless Ball Joint Pipe
4"-20" Flex-Lok Connecting Pieces**

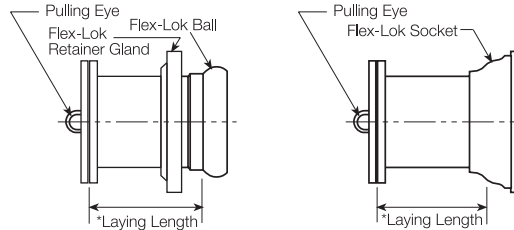

Table No. 10-8

| Size in. | Laying Lengths* | | Assembled Weight in Pounds | |
|----------|--------------------------------|----------------------------------|--------------------------------|----------------------------------|
| | Flex-Lok Ball Assembly Closure | Flex-Lok Socket Assembly Closure | Flex-Lok Ball Assembly Closure | Flex-Lok Socket Assembly Closure |
| 4 | 2'-10" | 2'-10" | 135 | 120 |
| 6 | 2'-9" | 2'-10" | 205 | 185 |
| 8 | 2'-8" | 2'-10" | 305 | 270 |
| 10 | 2'-7" | 2'-10" | 415 | 370 |
| 12 | 2'-7" | 2'-10" | 590 | 505 |
| 14 | 3'-1" | 3'-0" | 720 | 590 |
| 16 | 3'-2" | 3'-0" | 910 | 760 |
| 18 | 3'-3" | 3'-1" | 1130 | 935 |
| 20 | 3'-4" | 3'-2" | 1385 | 1135 |

*Laying lengths shown exclude the bolted on pulling flange.
 Pulling flange contains 2 taps (1" taps for 4"-10" and 2" taps for 12"-54").
 Flex-Lok Closure Assemblies are available on loan basis for use in installing lines by pulling and for testing of lines after installation.
 They are normally furnished in pairs, i.e., one Ball and Closed End Assembly and one Socket and Closed End Assembly.
 Assembled weights include the bolted on pulling flange

24"-54"† Flex-Lok Closure Assemblies

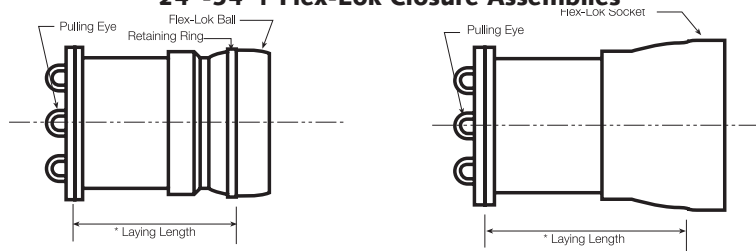

Table No. 10-9

| Size in. | Laying Lengths* | | Assembled Weight in Pounds | |
|----------|--------------------------------|----------------------------------|--------------------------------|----------------------------------|
| | Flex-Lok Ball Assembly Closure | Flex-Lok Socket Assembly Closure | Flex-Lok Ball Assembly Closure | Flex-Lok Socket Assembly Closure |
| 24 | 3'-5" | 3'-3" | 1910 | 1530 |
| 30 | 3'-7" | 3'-5" | 12480 | 12633 |
| 36 | 4'-0" | 3'-8" | 13976 | 14147 |
| 42 | 4'-8" | 4'-4" | 16481 | 16479 |
| 48 | 4'-9" | 4'-6" | 18614 | 19026 |
| 54 | 7'-0" | **9'-0" | 13378 | 13834 |

*Laying Lengths shown exclude the bolted on pulling flange.
 **Contact AMERICAN for the availability of a shorter closure piece if desired.
 Pulling flange contains 2 taps (2" taps for 12"-54").
 Flex-Lok Closure Assemblies are available on loan basis for use in installing lines by pulling and for testing of lines after installation.
 They are normally furnished in pairs, i.e., one Ball and Closed End Assembly and one Socket and Closed End Assembly.
 Assembled weights include the bolted-on pulling flange.
 †60" Flex-Lok Closure Assemblies are constructed differently than 24"-54", but with the same functionality (a pulling plug with taps is inserted in the bell or bell end, instead of a short length of flange pipe as pictured). Contact AMERICAN.



**AMERICAN Ductile Iron
Flex-Lok Boltless Ball Joint Pipe
4"-20"**
Assembly Instructions

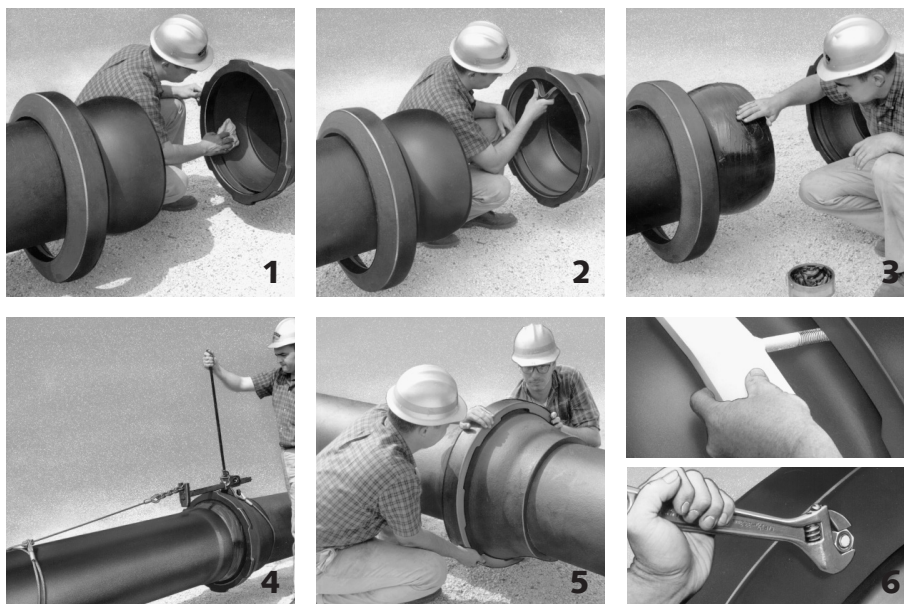

Field assembly of 4"-20" AMERICAN Flex-Lok Boltless Ball Joint Pipe is fast and simple. The following procedure is recommended:

1. Remove the steel straps holding the gland on the ball. Thoroughly clean ball and gasket recess in the socket. The intermediate Flex-Ring joint comes from AMERICAN pre-assembled, complete. Note that no solvents should be used in cleaning the ball and gasket recess.

2. Insert the special Flex-Lok gasket into the gasket recess with small section of gasket facing outward.

3. For underwater installation, coat entire ball and the exposed surface of the gland completely with the AMERICAN Underwater Joint Lubricant, which is furnished with the pipe. This coating will provide ample lubrication for assembly and joint flexing, and this special lubricant is insoluble in water.

4. Position the pipe in near straight alignment to facilitate assembly. Position the leading edge of the ball into the socket and

push or pull pipe together using methods similar to those shown on page 2-11.

5. Position the locking gland and rotate to interlock with matching lugs on the pipe bell.

6. Insert the steel locking wedge into the space between two lugs with threaded stud through one of the drilled holes in the gland (two holes are provided 180° apart, but only one locking wedge is required per joint). Secure wedge by tightening nut on threaded stud. This wedge securely locks the gland in place.

7. Disassembly of the joint may be accomplished by essentially following the assembly instructions in reverse order.

If required, an additional quantity of lubricant can be supplied or a lubricant can be prepared in the field by mixing one gallon of melted paraffin and one-half gallon of linseed oil. Do not use other lubricants as they may be injurious to the gasket or impart taste or odor to the conveyed water.



AMERICAN Ductile Iron
Flex-Lok Boltless Ball Joint Pipe (Internal Retaining Ring Type)
24"-60"
Assembly Instructions

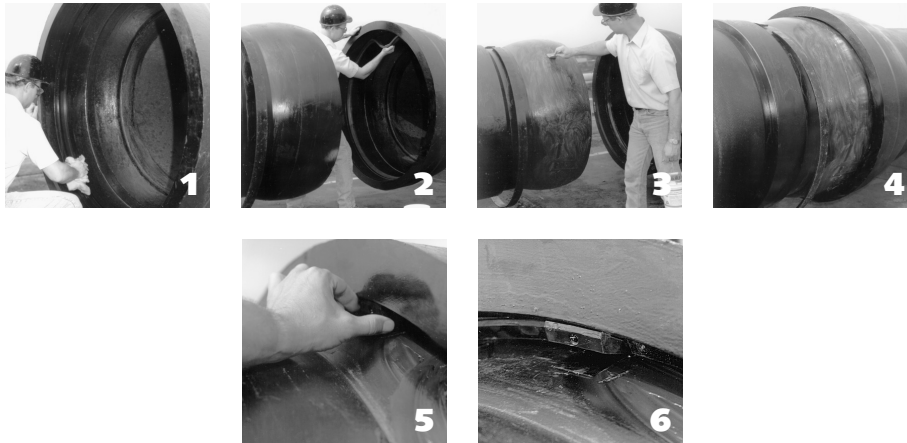

Field assembly of 24"-60" AMERICAN Flex-Lok Boltless Ball Joint Pipe is fast and simple. The following procedure is recommended:

1. Remove the steel strap, U-bolt and eye-bolt holding the retaining ring and let it hang freely on the shank of the ball. Thoroughly clean the outside of the ball and the socket recesses inside the bell. Do not remove protective coating from ball or bell. Note that no solvents should be used in cleaning the ball and gasket recess.

2. Insert the special Flex-Lok gasket into the gasket recess with small section of gasket facing outward.

3. For underwater installation, coat entire ball and the exposed surface of the ring completely with the AMERICAN Underwater Joint Lubricant, which is furnished with the pipe. This coating will provide ample lubrication for assembly and joint flexing, and this special lubricant is insoluble in water.

4. Position the pipes in near straight alignment to facilitate assembly. Position the leading edge of the ball into the socket. Pull pipe together using a device such as a roller chain pull lift, which can be furnished by AMERICAN if desired.

5. Orient the loose retaining ring so the gap is at the top. Insert retaining ring into recess inside bell. Check to ensure ring is in the socket recess all the way around the joint.

6. Insert the assembly clip in the space between the ring ends and push or caulk into position. **Note that the spring end of the clip must be oriented inward toward the ball as shown on page 10-4 and in Photo 6 above.**

7. Disassembly can be easily accomplished with a reversal of these instructions. Any pulled or extended joints must, of course, be first pulled or pushed back together to allow removal of the assembly clip and the retaining ring. Also, a small tapped hole is provided in the face of the loose retaining ring approximately 180° from the assembly clip (normally at the bottom). A bolt can be threaded into this hole if disassembly is needed. This is often helpful in lifting the retaining ring out of engagement in the socket.

If required, an additional quantity of lubricant can be supplied or, in some cases, a lubricant can be prepared in the field by mixing one gallon of melted paraffin and one-half gallon of linseed oil. Do not use other lubricants as they may be injurious to the gasket or impart taste or odor to the conveyed water. Approximately 2" of relative separating movement or "joint take-up" will occur in each joint if the joint is extended or "pulled" (before locking members metal-bind to prevent further movement).



AMERICAN Ball Joint Pipe Installations Methods of Installation

Time and time again, AMERICAN Ball Joint Pipelines have been installed where the conditions of the job site have challenged the ingenuity of the design engineer and installation contractor. The design features of Flex-Lok Pipe make it readily adaptable to extremely difficult situations. It has been installed by a variety of methods — both unique and conventional — with an unexcelled record of success.

Many installations have been made using marine equipment, thus minimizing or eliminating all underwater work. Unnavigable and navigable waters have been crossed with all joining and installation work being performed on the opposite banks, with appropriate design and construction planning.

The majority of installations involve one or more of the installation procedures described as follows:

Installation From Bank (Line Pulling)

In many instances it is possible to plan installation methods for waterway crossings so that work will be confined to firm ground with offshore operations minimized or eliminated. AMERICAN Flex-Lok Joint Pipe may be assembled on an inclined ramp, or on launching ways, and pulled to the opposite shore by cable. The entire line may be moved as a unit or in sections. The line may be floated or pulled directly into an excavated trench depending on existing conditions.

AMERICAN Flex-Lok Joint Pipe is positively locked against separation and the allowable end pull permits the assembled pipe to be pulled as a line into otherwise inaccessible areas such as rivers, swamps and quicksand.

The joints are designed so that the joint sealing is not affected by the tension of pulling, and after the line is in final position, no further joint work is necessary. Many installations have been made by this method, and on several occasions two or more parallel lines have been pulled simultaneously.

In the construction of a ramp, the most readily available materials can be used, such as timbers, rails or steel beams. Pipe may be assembled so that the heavy flanges are in contact with the ramp or the pipe may be cradled on cross supports equipped with guide cleats. The design of the ramp and the materials used dictate how the pipe should be supported. The deflection of individual joints provides line flexibility, enabling movement



Bank installation in progress, where most of the work is performed on firm ground and the pipe is pulled across waterway by cable. (Note rail weights strapped on to create slight negative buoyancy of this size line pulled beneath barge traffic).



AMERICAN DUCTILE IRON PIPE

through moderate bends into various elevations and locations. The grade and long radius bend of the ramp are planned for gradual line deflection and maximum control of line movement.

In line pulling, analysis of bottom conditions should be made by thorough soundings to determine possible obstructions and resistance to be encountered by the pipe, as well as support for the pipeline in contact with the bottom.

Closure pieces with cable eyes and test taps can be furnished with the pipe on a rental basis.

An advantage is sometimes obtained by fastening an improvised deflector or sled in front of the lead socket flange.

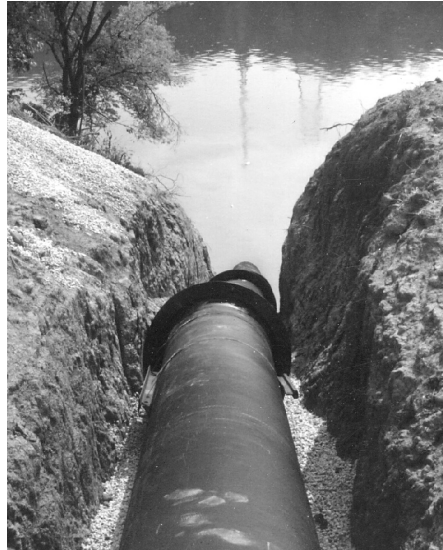

Flex-Lok Joint Pipe can be pulled into position with a bulldozer, winch or crane with "dead man."

Line Flotation

AMERICAN Flex-Lok Joint Pipe can be installed by various methods including the use of line flotation. Some sizes of unfilled pipe are lighter than the water they displace and will float. See Table Nos. 10-1 and 10-2. If the unfilled pipe is heavier than the water it displaces, then pontoons must be secured to the line to provide the buoyancy if flotation is desired.

Unless bottom conditions or other circumstances dictate that the line be floated into position, it is usually better to pull the line submerged along the bottom with slight negative buoyancy. When necessary,

pontoons may be used to lighten the weight of a long line pulled along the bottom.

Unless water depth is relatively shallow, approximately 10 feet or less, a line floated into position should be supported as it is lowered to the bottom. This precaution is necessary to avoid placing excessive deflection and beam stresses on the joints.

Used commercial steel drums are generally available and often can be economically used as pontoons during installation. In designing flotation gear, consideration should be given to the depth at which the drums used will collapse due to external pressure.



Flotation provided by attached spheres facilitated installation of this 30" pipeline with Flex-Lok Joints.



48" Flex-Lok Pipe being positioned for assembly. The ramp attached to the barge is used as the assembly platform, and as the joints are made, the barge is moved forward, allowing assembled piping to slide into the water.

Installation From a Barge

Designed especially for submarine installations, AMERICAN Flex-Lok Joint Pipe is adaptable for installation from practically any barge or other type of marine equipment that can be used for laying pipe from the water's surface. The ruggedness and flexibility of the Flex-Lok Joint permits the suspension of the end of the pipeline above water for the addition of pipe while the balance of the line is suspended on a launching ramp or rests on the bottom.

Normally a ramp is employed in conjunction with the barge for the best control

of movement, prevention of undesirable bending loads on joints and for ease of operation. The ramp is designed to reach from the barge to the bottom and to rise and fall with the changing bottom elevations. As pipe is added onto the suspended end of the line, the barge is moved forward, pulling the ramp from under the suspended section allowing it to progressively descend to the bottom. Care should be taken to prevent any barge movement that could cause damaging overdeflection and bending moments to occur in the pipe joints.



AMERICAN Ball Joint Pipe Recommendations

Installation

The outstanding construction advantages afforded by AMERICAN Flex-Lok Pipe should be fully considered and used for long, trouble-free service.

For example, where river bottoms are of unstable soils, the flexibility of Flex-Lok Pipe will allow substantial line movement or settlement, and remain leak-free. Movement of the installed line, however, should be minimized as far as practical and confined to the underwater section of the line. It is suggested that the river bottom be trenched or dragged to stable soils where practical. Also, the ends of the lines extending above the water should be stabilized for connection to other lines. It is generally suggested that the ends of the crossings be installed in firm earth, above the high-water mark, to provide firm anchorage. Where the connecting ends of the crossings cannot be located in firm soils, other suitable means of anchoring should be provided.

After a river crossing is installed, it is normally suggested that the line be backfilled and allowed to settle for a reasonable period before end connections are made. This is due to uncertain bedding conditions that may be present in many installations. Submerged lines should be filled with water to aid their settlement.

The significant deflection provided by AMERICAN Ball Joints practically eliminates the need for line fittings; however, where steep approaches or horizontal bends are encountered requiring greater than normal line deflection, the use of short AMERICAN

Ball Joint connecting pieces will provide additional deflection within a short distance.

Testing

Upon completion of a river crossing, the ends of the line may be closed for testing by the use of closure pieces, which are available on loan from AMERICAN.

Connections

When connecting Ball Joint river crossing lines to land lines, the river crossing pipe should normally be installed first.

Sleeves are often used for connecting Ball Joint pipe to other pipelines. Such connections facilitate the joining of a field-cut piece, allow moderate movement of the river crossing ends, reduce stresses and provide for easy line maintenance.

Long pattern mechanical joint sleeves are recommended for making connection to mechanical joint or Fastite joint ductile iron pipe, both of which have the same outside diameters as Ball Joint pipe. Connections to pipe of other diameters require special connecting pieces designed to fit specific installation requirements.

The use of AMERICAN Flex-Lok Joint Pipe with or without special restrained expansion sleeves may be advantageous in seismic environments.

AMERICAN will assist in any river crossing project by making a detailed layout and by giving suggestions for installation procedures to accomplish the crossing.

Section 11

AMERICAN Linings and Coatings





AMERICAN Linings for Pipe and Fittings

The principal standard covering cement lining is ANSI/AWWA C104/A21.4. This and other standards are referenced throughout this Section either by the full ANSI/AWWA designation or by only the AWWA numbering, such as AWWA C104.

Along with technical and metallurgical advancement in piping materials, research on lining requirements for pipe and fittings has resulted in the development of linings to meet many different service requirements. AMERICAN offers several types of linings, the most common being cement lining. Pipe and fittings furnished by AMERICAN are offered unlined or with linings as follows:

1. Cement Lined per AWWA C104.
2. Asphaltic Lined per AWWA C110, C115 or C151.
3. Fusion-Bonded Epoxy (for 4" -16" Fastite fittings) per AWWAA C116.
4. Special Lining - for unusual service conditions

Cement Lining

Cement-mortar lining for ductile iron pipe and ductile and gray iron fittings for water service is in accordance with ANSI/AWWA C104/A21.4.

Cement-lined pipe is also furnished for some sewage service and a number of other applications. In fact, most pipe furnished is cement lined, providing improved flow characteristics and the required protection against internal corrosion. The cement lining is satisfactory for temperatures up to 212°F. If asphaltic seal coat is furnished, the lining is only adequate for temperatures up to 150°F. For other services contact AMERICAN regarding temperature limitations of cement lining.

The first recorded installation of cement-lined gray iron pipe was in 1922 at Charleston, S.C. This lining was developed by the Charleston Commission of Public Works in cooperation with American Cast Iron Pipe Company. Since this beginning, AMERICAN has furnished most of its pipe with cement lining. The lining is applied centrifugally with the speed of rotation designed to produce a smooth waterway surface, minimal voids, yet retaining enough moisture for proper curing. AMERICAN cement-lined pipe and fittings are listed by

ANSI/NSF Standard 61 for potable water contact.

Flow tests on cement-lined pipe under varying service conditions have established that the Hazen-Williams flow coefficient remains as expected at about 140, and flow tests on cement-lined, large-diameter AMERICAN Ductile Iron pipe have confirmed flow coefficients much higher than 140.

Handling Cement-Lined Pipe and Fittings

Pipe and fittings with cement lining should be handled with rubber-covered hooks or other type equipment to prevent damage to the cement lining. Bare forklift arms or bare hooks should not be inserted into open ends.

Characteristics of Cement Lining

AWWA C104 allows for surface crazing and cracks of a specified nature and magnitude. Occasionally cracks and looseness in linings may occur prior to installation, particularly where pipe is stored for a considerable time. Many years' experience with cementlined pipe and fittings has verified that this condition is not detrimental to the perfor-



mance and effectiveness of the lining. When a cement-lined pipe is placed in service and filled with water, two reactions begin immediately. The first is a gradual elimination of the temperature differential between pipe and lining, thus eliminating any stresses in the lining due to this condition.

Secondly, the lining begins to absorb water into the pores of the cement and into the capillary channels of the calcium silicate gel. The water absorption causes the lining to swell, restoring it to intimate contact with the pipe wall and virtually closing any cracks present in the lining. This swelling process is relatively slow, taking up to several weeks for the lining to be restored to its maximum volume. This process has been demonstrated on a number of occasions to the satisfaction of customers, contractors and engineers by immersing a pipe or fitting in water for one or two weeks.

After a period of exposure to water, not only does the lining tighten against the pipe wall and the cracks close, but finally the surfaces of the cracks actually re-bond. This occurs by a process called autogenous healing.

This phenomenon, long recognized by the cement industry, has been documented by laboratory tests to occur in cement-lined ductile pipe. In one test, a 48" ductile iron pipe with severely cracked cement lining was held half full of water for several months. At the end of that period, the lining both above and below the water surface was found to be tight, with all cracks either healed completely or sealed by the formation of calcium carbonate.

Field inspections of lines that have been in service for many years have verified the laboratory results; cement linings do tighten and heal in service and provide the corrosion protection to the pipe and the high flow coefficients for which they were designed.

Field Repair of Damaged Cement Linings

Cement lining will withstand normal handling; nevertheless, pipe or fittings may be found at times to have damaged linings which need to be repaired before placing in service.

AWWA C104 provides that damaged lining may be repaired, and the following repair procedure is recommended:

1. Cut out the damaged lining to the metal. Square the edges.
2. Thoroughly wet the cut-out area and adjoining lining.
3. With the damaged area cleaned and the adjoining lining wet, spread the mortar (see recommended mix below) evenly over the area to be patched. (See Table No. 11-1, next page, for lining thicknesses.) After the lining has become firm and adheres well to the surface, finish it with a wet 3" or 4" paint brush or similar soft bristle brush.
4. The repaired lining should be kept moist by tying canvas, wet burlap, or other wrap over the ends of the pipe or fitting for at least 24 hours. As an alternative the repaired lining may be seal coated with a cut back type of asphaltic seal coating. This must be sprayed or brushed on within five to 30 minutes after lining. To maintain NSF certification, patch must be made using a NSF certified cement for 4" pipe and larger, or the patch must be topcoated with NSF certified asphalt paint.

Recommended Cement Mix

Cement mix by volume: 3 parts of sand, 2 parts cement.

Precautions

1. Mortar for lining should not be used after it has been mixed for more than one hour.
2. Too rapid a loss of moisture from fresh linings due to hot weather or high wind will prevent proper cure, resulting in the lining being soft and powdery. To prevent this loss of moisture, (a) do not line hot castings and (b) close the ends of the castings with wet burlap.
3. Fresh linings that become frozen will not be serviceable. Avoid lining in freezing weather.



Cement Lining
ANSI/AWWA C104/A21.4
Thicknesses and Weights

Table No. 11-1

| Size in. | Nominal Pipe Length ft. | Standard Thickness | | | Double Thickness | | |
|----------|-------------------------|-----------------------|--------------------|----------------------|-----------------------|--------------------|------------------------------|
| | | Minimum Thickness in. | Weight Per Foot lb | Weight Per Length lb | Minimum Thickness in. | Weight Per Foot lb | Weight Per Nominal Length lb |
| 4 | 18 | 1/16 | .87 | 17 | 1/8 | 1.71 | 31 |
| 6 | 20 | 1/16 | 1.30 | 26 | 1/8 | 2.57 | 51 |
| 8 | 20 | 1/16 | 1.74 | 35 | 1/8 | 3.45 | 69 |
| 10 | 20 | 1/16 | 2.15 | 43 | 1/8 | 4.28 | 86 |
| 12 | 20 | 1/16 | 2.57 | 51 | 1/8 | 5.12 | 102 |
| 14 | 20 | 3/32 | 4.49 | 90 | 3/16 | 8.93 | 179 |
| 16 | 20 | 3/32 | 5.13 | 103 | 3/16 | 10.19 | 204 |
| 18 | 20 | 3/32 | 5.76 | 115 | 3/16 | 11.47 | 229 |
| 20 | 20 | 3/32 | 6.40 | 128 | 3/16 | 12.73 | 255 |
| 24 | 20 | 3/32 | 7.68 | 154 | 3/16 | 15.31 | 306 |
| 30 | 20 | 1/8 | 12.76 | 255 | 1/4 | 25.42 | 508 |
| 36 | 20 | 1/8 | 15.31 | 306 | 1/4 | 30.51 | 610 |
| 42 | 20 | 1/8 | 17.82 | 356 | 1/4 | 35.53 | 711 |
| 48 | 20 | 1/8 | 20.35 | 407 | 1/4 | 40.60 | 812 |
| 54 | 20 | 1/8 | 22.89 | 458 | 1/4 | 45.68 | 914 |
| 60 | 20 | 1/8 | 24.71 | 494 | 1/4 | 49.32 | 986 |
| 64 | 20 | 1/8 | 26.35 | 527 | 1/4 | 52.61 | 1052 |

Weights are based on the minimum lining thicknesses for minimum pressure classes of Fastite ductile iron pipe. Actual lengths and weights may differ from above.
 Linings may taper at the ends.
 AMERICAN recommends the use of standard thickness cement lining per AWWA C104 for all normal installations.



This 64" Ductile Iron Fastite Joint water transmission main was furnished with standard cement lining for continuing high flow performance.



Other Linings Available From AMERICAN

ASPHALTIC LINING

AMERICAN furnishes some pipe and fittings lined with an asphaltic material in accordance with AWWA C110, C115, C153 and C151. After thoroughly drying, the lining has no deleterious effect upon the quality, color, taste or odor of potable water. Asphaltic lining is not normally used in water service; the majority of ductile water lines are cement lined. Asphaltic lining or seal-coat, if furnished, on cement lining is adequate for temperatures up to 150°F.

SPECIAL LININGS

Cement lining has proven effective as a lining for iron pipe in most water service applications, and an industry standard for cement lining is in place. Cement lining is applied at the pipe casting factory as part of routine manufacturing.

When service conditions go beyond basic water, a more thorough evaluation is called for, and a special lining applied by a third-party applicator may be indicated. This

may include glass lining, epoxy lining and other special linings.

Because of the variables and complexities involved in special linings other than cement for special services other than basic water, AMERICAN directs inquiries for technical assistance and referrals to various lining manufacturers and their products, services, terms and conditions.

OTHER SPECIAL LININGS

Customers can request pipe and fittings with special linings other than those listed above (e.g., glass lining, etc.). Because of the variables and complexities involved in the selection of a proper lining for a given service, AMERICAN invites inquiries for technical assistance, availability and cost.

UNLINED

Because some service applications may require unlined pipe & fittings, AMERICAN furnishes any of its products without lining when so specified at time of purchase.



AMERICAN Coatings and Primers for Pipe and Fittings

Several different types of exterior primers for pipe and fittings are available from AMERICAN. Because of variables and complexities involved in the selection and application of a proper coating for a given service, AMERICAN invites inquiries for technical assistance.

ASPHALTIC

AMERICAN furnishes most pipe and fittings coated outside with an asphaltic coating approximately one mil thick per AWWA C151 for ductile iron pipe, AWWA C115 for flanged pipe and AWWA C110 and C153 for fittings.

All across the United States ductile iron and gray iron pipe and fittings with this standard coating have provided trouble-free service for decades. Unless otherwise specified, an asphaltic coating is applied to the outside of all pipe and fittings manufactured by AMERICAN.

The asphaltic coating works in conjunction with manufacturing annealing scale to provide a barrier to corrosion. If soils are deemed to be corrosive to ductile iron pipe when evaluated in accordance with the Design Decision Model™ (DDM™*) or Appendix A of AWWA C105, zinc coating with or without V-Bio polyethylene wrap should be used.

Asphaltic coating is not compatible with most top coats. See the following alternative coating and primer recommendations.

*DDM™ (Design Decision Model™) developed jointly by Corpro Companies, Inc., and the Ductile Iron Pipe Research Association.
See american-usa.com, dipra.org or corpro.com for details.

PHENOLIC ALKYD PRIMER

This is a fast-drying, lead- and chromate-free, corrosion-resistant primer formulated to accept a wide variety of topcoats. It is well suited for applications where the generic topcoats are unknown but its service is limited to atmospheric exposure. Refer to AMERICAN Alkyd-Phenolic Primer.

NOTE: NOT RECOMMENDED FOR IMMERSION. MUST ALLOW UP TO 30 DAYS OF CURING BEFORE TOPCOATING WITH CERTAIN COATINGS.

EPOXY PRIMER

This is a high-solids, chemical- and corrosion-resistant coating for protection against abrasion, moisture, corrosive fumes, chemical attack and immersion.



This 30" AMERICAN Ductile Iron Fastite joint treated-water transmission main was furnished and installed—as is most ductile iron pipe—with standard asphaltic coating approximately one mil thick on the outside.



AMERICAN DUCTILE IRON PIPE

High-build properties provide outstanding corrosion protection with fewer coats, particularly on edges. Such high solids, high film-build epoxies are compatible with most catalyzed finish coats.

Typical (field) finish coatings include: epoxies (amine, polyamide, polyamidoamine, water-borne, coal-tar) and polyurethane. Refer to **AMERICAN Polyamidoamine Epoxy Primer**. **NOTE: AFTER 60 DAYS OF CURING, THIS PRIMER SHOULD BE UNIFORMLY SCARIFIED BY BRUSH-BLASTING WITH FINE ABRASIVE BEFORE TOPCOATING.**

OTHER SPECIAL COATINGS

AMERICAN can also furnish other special exterior coating systems. Contact AMERICAN for technical assistance in the selection of special exterior coating systems, lead times and costs. See pages 11-9 through 11-11 for additional information related to metallic zinc coating.

UNCOATED PIPE

Because some customer applications may require piping or fittings that have no coating applied to the exterior, AMERICAN furnishes, when specified at time of purchase, any of its products without exterior coatings.

While AMERICAN can supply uncoated, bare pipe to meet customer specifications, it is recommended to use an asphaltic or other approved coating on the spigot when assembling a joint to reduce the probability of displacing a gasket and to reduce the overall assembly load.

NOTE: AMERICAN also has the ability to furnish other primers, but this may affect price and availability.

AMERICAN Cast Iron Pipe Company Standard O.D. Shop Primer Systems

RECOMMENDED AND PREFERRED PRIMER

Alkyd-Phenolic Primer

Interior/Exterior/Non-Immersion (Above Grade Only)

- Single-coat thickness: 2.0-4.0 mils DFT (50-101 microns).
- Typical Topcoats: alkyds, aluminums, epoxies, and urethanes.
- Coating must be cured for 30 days before being overcoated with certain topcoats.
- This primer is **not** recommended for immersion service.
- This primer is compliant with NSF Standard 61 **as an exterior surface coating only.**

Polyamidoamine Epoxy Primer

Interior/Exterior/Immersion (Above and Below Grade)

- Single-coat thickness: 3.0-8.0 mils DFT (76-203 microns).
- Typical Topcoats: epoxies and urethanes.
- This coating must be lightly blast cleaned before topcoating if it has not been exterior exposed for 60 days or longer.
- This primer is compliant with ANSI/NSF Standard 61 for potable water contact for pipe, fittings, and valves when combined with approved topcoats.



Zinc-Coated Ductile Iron Pipe

AMERICAN is proud to introduce the latest advancement in corrosion control for iron pipe, zinc coating. Zinc has been used to effectively eliminate corrosion in iron pipe for more than 50 years. Internationally, this advanced coating system has been used to protect millions of feet of cast and ductile iron pipe in corrosive environments.

AMERICAN began supplying zinc coating for our export orders starting in the early 1980s. Now, we're pleased to offer this proven system to domestic markets. Zinc coating significantly extends the life of an already rugged and reliable product – ductile iron pipe.

A Brief History of Zinc Coatings

Zinc dust was first added to paints for corrosion control as early as 1837. Since then, zinc-rich paints have received widespread acceptance for metallic corrosion control around the world.

The water industry first began using zinc coatings on iron pipe in Europe in 1955. As a result of zinc's widespread use there, the ISO standards 8179 and BSEN 545/598 were both developed and widely adopted.

Beginning in the early 1980s the mass of zinc applied to iron pipe was increased from the original 130 grams per square meter (g/m^2) to the current 200 g/m^2 . This amount, with a protective topcoat, has proven optimal for life extension of iron pipe. Also, in the early 1980s, AMERICAN began supplying the zinc-rich ISO coatings on ductile iron pipe for our international orders.

Key Dates in the Development of Zinc Coatings for Ductile Iron Pipe

| | |
|------|--|
| 1958 | Zinc coating was first applied to cast iron pipe in Europe for corrosion protection. |
| 1963 | Standard bitumen/coal-tar paint was applied for normal environments in Europe. |
| 1963 | Polyethylene sleeve was recommended for soil resistivities of less than 400 ohm-centimeter by French pipe maker Pont-à-Mousson. |
| 1972 | Germany and Austria began to standardize the use of zinc coatings on iron pipe. |
| 1982 | AMERICAN supplied its first international order with a zinc coating. |
| 1984 | All ductile iron manufacturers in the United Kingdom started supplying all new ductile iron pipe in the diameter range 80 - 800mm with a zinc coating. |
| 1984 | Zinc spray of 130 g/m^2 under bitumen paint became common in Europe. |
| 1995 | Zinc spray of 200 g/m^2 under bitumen paint became the standard in Europe. |

Zinc Coatings for Iron Pipe Today

The advances in zinc coatings over the past 60 years have resulted in a highly effective corrosion inhibiting product. According to the International Zinc Association, products coated with zinc *"are slow to enter the recycling circuit due to the very nature of their durability. The life of zinc-containing products is variable*

and can range from 10-15 years for cars or household appliances, to over 100 years for zinc sheet used for roofing." With a projected lifespan of well over 100 years, zinc coating on ductile iron pipe is the most effective and dependable way to further extend the lifespan of an already rugged and durable product.



A Specification for Zinc Coating on Ductile Iron Pipe

A. Standards: Ductile iron pipe shall conform to AWWA C150 and C151, subject to the following supplemental requirements. The pipe shall be of the diameter and class shown, shall be furnished complete with rubber gaskets as indicated in the Contract Documents, and all specials and fittings shall be provided as required under the Contract Documents. The ductile iron pipe shall be manufactured or supplied by AMERICAN Ductile Iron Pipe or pre-approved equal. Joints shall conform to AWWA C111, cement linings to AWWA C104, fittings to AWWA C153 or C110.

B. Markings: Upon request, the CONTRACTOR shall require the MANUFACTURER to legibly mark specials in accordance with a laying schedule and marking diagram. All other cast marks and other marks shall be in accordance with applicable Standards.

C. Laying Lengths: Pipe laying lengths shall be provided in 20 foot nominal lengths with allowable trim pipe lengths in accordance with AWWA C151 and special shorter lengths provided as required by the Drawings.

D. Joint Design: Ductile iron pipe shall be furnished with push-on joints or push-on restrained joints. Restrained joints shall be AMERICAN Fast-Grip, Flex-Ring, or Lok-Ring.

E. Lining: Except otherwise provided herein, interior surfaces of all ductile iron pipe, fittings, and specials shall be cleaned and lined at the pipe casting facility with a standard thickness cement mortar lining applied in conformity with AWWA C104. A seal coat shall not be applied to the surface of the cement-mortar lining.

F. Coating: The exterior of ductile iron pipe shall be coated with a layer of arc-sprayed zinc per ISO 8179. The mass of the zinc applied shall be 200 g/m² of pipe surface area. A finishing layer topcoat shall be applied to the zinc. The coating system shall conform in every respect to ISO 8179-1 "Ductile iron pipes - External zinc-based coating - Part 1: Metallic zinc with finishing layer. Second edition 2004-06-01."

G. Installation: Ductile iron pipe shall be loaded, transported, unloaded, installed, and tested in accordance with AWWA C600.



Zinc Coated Ductile Iron Pipe for Corrosion Control

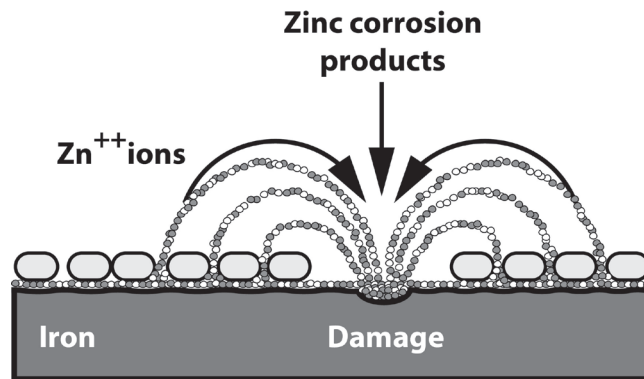
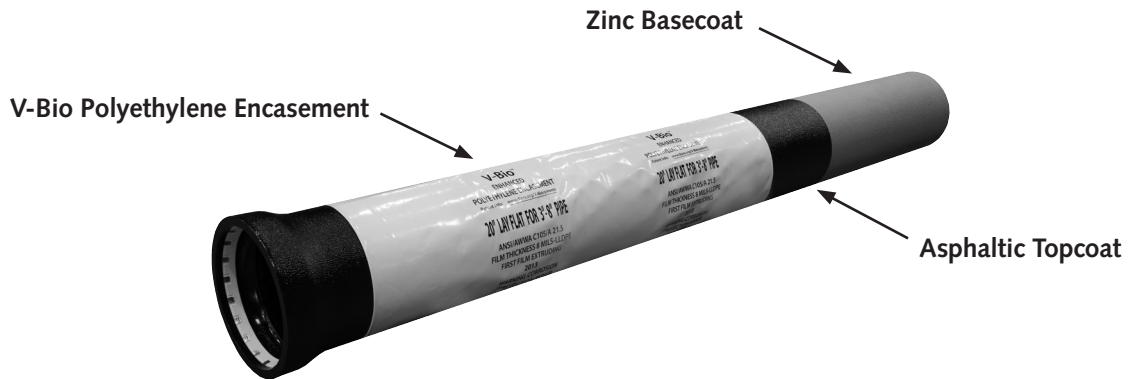

Zinc is anodic to iron. That means iron is the more stable, more noble, of the two elements. Zinc will cathodically protect the iron pipe as long as zinc is present, and over time, will convert to zinc compounds that provide an enduring passivating layer under the topcoat, which protects the pipe against further corrosive attack. Zinc is an anode, uniformly adhered to the surface of the pipe.



Repair Instructions for Ductile Iron Pipe Coated with Metallized Zinc and Asphaltic Top Coat

In general, the zinc layer does not require touch-up if its damaged area is less than 0.75² and/or less than 0.188 in. wide. Should the damage or scratch exceed this size or width use the procedure below to repair both the zinc and the asphaltic topcoat. For scratches and damage less than this width and area that exhibit rusting, follow the surface preparation guidelines and simply re-apply the asphaltic coating.

Read and follow all pipe and paint manufacturers' cautions and instructions included in product data sheets, application guides and SDS sheets.

Surface Preparation

Remove any contaminants or loose coating from the damaged area by using a wire brush, sand paper and/or solvent.

Repair

1. Remove the asphaltic topcoat from the area surrounding the damage using a wire brush and/or solvent cleaning. Remove the asphalt at least 1" beyond the damage area.
2. Apply one coat of zinc-rich paint overlapping the undamaged zinc coating.
3. Allow the zinc-rich painted section to dry to touch/handle per the paint manufacturer's recommendations.
4. Apply one coat of asphaltic paint on top of the zinc-rich paint overlapping the adjacent asphaltic paint.
5. Recommended products include Tnemec Zinc Series 90-98, Sherwin Williams Corothane® Galvapak 1k Zinc Primer, and Ergon Asphaltic R-17-A Topcoat.



V-Bio Enhanced Polyethylene Encasement

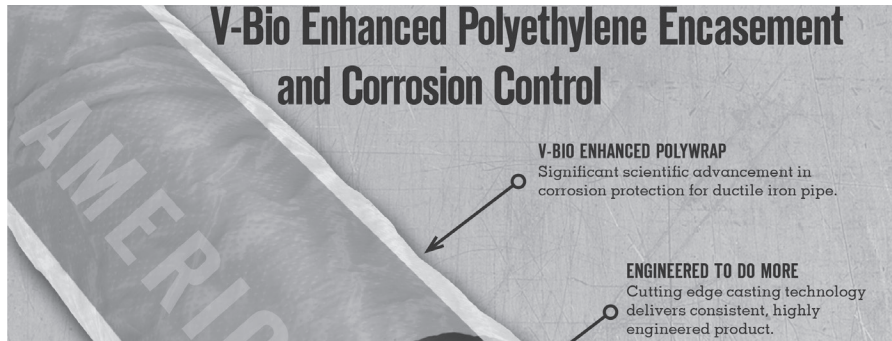

Product Description

V-Bio, the latest advancement in corrosion control for ductile iron pipe, is an enhanced polyethylene encasement that targets anaerobic bacteria on the surface of the pipe and inhibits the formation of corrosion cells under the wrap.

Already known for its corrosion control properties, polyethylene encasement has been used to successfully protect cast and ductile iron pipe in aggressive environments since its first use in a water system in 1958. And now, with V-Bio, this wrap offers even greater protection of the industry's most dependable, economic and long lasting pipe material.

Key facts about the V-Bio enhanced polyethylene encasement:

- Builds on a proven method of corrosion control — polyethylene encasement — that has been protecting iron pipe from aggressive soils since it was first installed in 1958.
- Represents a significant evolutionary advancement in corrosion protection for ductile iron pipe.

- Consists of three layers of co-extruded linear low-density polyethylene (LLDPE) film fused into one.

- Features an inside surface that is infused with a proprietary blend of an anti-microbial compound to mitigate microbiologically influenced corrosion ("MIC") and a volatile corrosion inhibitor ("VCI") to control galvanic corrosion.

- Protects against corrosion without consuming or degrading the compound or the corrosion inhibitor. The film's enhanced properties will last over time.

- Meets all requirements of the American National Standards Institute and the American Water Works Association (ANSI/AWWA C105/A21.5) standard for polyethylene encasement.

- The most advanced method of corrosion control.

For details about V-Bio enhanced polyethylene encasement, ductile iron pipe or the Ductile Iron Pipe Research Association visit: www.dipra.org/v-bio/



Standard Dimensions and Weights

Table No. 11-2

| Pipe Size (in.) | Lay Flat size | Length Per Roll ¹ | Tape Required ² per Joint (ft.) | Weight Per Roll ¹ |
|-----------------|---------------|------------------------------|--|------------------------------|
| 4 | 20 | 500 | 5 | 72 |
| 6 | 20 | 500 | 6 | 72 |
| 8 | 20 | 500 | 8 | 72 |
| 10 | 27 | 380 | 9 | 73.9 |
| 12 | 27 | 380 | 10 | 73.9 |
| 14 | 34 | 300 | 11 | 73.44 |
| 16 | 34 | 300 | 12 | 73.44 |
| 18 | 41 | 260 | 13 | 73.8 |
| 20 | 41 | 260 | 15 | 73.8 |
| 24 | 54 | 210 | 17 | 81.6 |
| 30 | 67 | 175 | 21 | 72.4 |
| 36 | 81 | 175 | 25 | 75.27 |
| 42 | 81 | 175 | 28 | 75.27 |
| 48 | 95 | 110 | 32 | 82 |
| 54 | 108 | 110 | 35 | 83.64 |
| 60 | 108 | 110 | 36 | 83.64 |
| 64 | 121 | 100 | 39 | 74.96 |

¹ Weights and lengths subject to change.

² Based on one turn at each end, six 4" long strips to secure loose wrap plus approximately 5% extra.

A Specification for V-Bio Enhanced Polyethylene Encasement for Ductile Iron Pipe

Polyethylene encasement for use with ductile iron pipe shall meet all the requirements for ANSI/AWWA C105/A21.5, *Polyethylene Encasement for Ductile Iron Pipe Systems*.

In addition, polyethylene encasement for use with ductile iron pipe systems shall consist of three layers of co-extruded linear low density polyethylene (LLDPE), fused into a single thickness of not less than eight mils.

The inside surface of the polyethylene wrap to be in contact with the pipe exterior shall be infused with a blend of antimicrobial compound to mitigate microbiologically influenced corrosion and a volatile corrosion inhibitor to control galvanic corrosion.

Ductile iron pipe and the polyethylene encasement used to protect it shall be

installed in accordance with AWWA C600 and ANSI/AWWA C105/A21.5 and also in accordance with all recommendations and practices of the AWWA M41, *Manual of Water Supply Practices – Ductile Iron Pipe and Fittings*. Specifically, the wrap shall be overlapped one foot in each direction at joints and secured in place around the pipe, and any wrap at tap locations shall be taped tightly prior to tapping and inspected for any needed repairs following the tap.

All installations shall be carried out by personnel trained and equipped to meet these various requirements.

The installing contractor shall submit an affidavit stating compliance with the requirements and practices of ANSI/AWWA C150/A21.50, ANSI/AWWA C151/A21.51, ANSI/AWWA C105/A21.5, AWWA C600 and M41.



Traditional Polyethylene Encasement

In areas where severely aggressive soils are encountered, the use of a polyethylene tube or sheet encasement has been proven to provide highly effective, economical protection. The protection against corrosion provided by loose polyethylene is different in several ways and should not be confused with coatings applied directly to the barrel of the pipe. The most significant difference is its ability to protect without creation of concentration cells at holidays. Also, since the encasement is applied when the pipe is actually put in the ground, coating damage due to shipping, handling, etc., is minimized.

As water may be present in the soil around the pipe, water may also be present between the pipe and wrap. Water inside the polyethylene tubing initially bears some characteristics of the soil environment, and corrosion may start. But within a short period of time initial oxidation depletes the oxygen supply in the water, and other electrochemical corrosion reactions also progress to completion. At this point a state of chemical equilibrium is reached.

Since the first field installation of polyethylene wrap on gray iron pipe in 1958, installations have been made in severely corrosive soils throughout the United States. The success of the polyethylene encasement procedure developed in the United States has been adopted by several other countries, and an International Standard for Polyethylene Sleeving (ISO- 8180) has been developed.

Research by the Ductile Iron Pipe Research Association at several severely corrosive test sites has verified that polyethylene encasement provides a high degree of protection and results in minimal and generally insignificant exterior surface

corrosion of either ductile or gray iron pipe thus protected. These findings have been confirmed by the results of numerous investigations of field installations.

Field tests have also indicated that the dielectric capability of polyethylene provides shielding for ductile and gray iron pipe against stray current at most levels encountered in the field.

Because polyethylene encasement is a passive method of protecting ductile iron pipe in aggressive soils, it can effect greater reliability and savings than cathodic protection systems which require continual monitoring, maintenance and other operating expenses, and trained personnel. Cathodic protection systems can also cause collateral harm in some cases to nearby unprotected ferrous structures.

For protection in areas of severely aggressive soils, AWWA C105 covers materials and installation procedures for polyethylene encasement of underground installations of ductile iron piping for water and other liquids.

Polyethylene wrap in tube or sheet form for piping encasement is manufactured of virgin polyethylene material conforming to the requirements of ANSI/ASTM Standard Specification D1248. The specified minimum thickness for linear low-density polyethylene film is 0.008 in. (8 mils). The specified minimum thickness for high-density, cross-laminated polyethylene film is 0.004 in. (4 mils).

Material, required markings, and installation methods are all in accordance with the requirements of AWWA C105. This standard and more detailed publications by DIPRA regarding loose polyethylene encasement are available from AMERICAN.



**Traditional Polyethylene Tubing and Tape
ANSI/AWWA C105/A21.5**



Tubing in Roll

Table No. 11-3

| Pipe Size in. | Flat Tube† Min. Width in. | Approximate Weight in Pounds 8 mil low-density P.E. | | Approx. weight (lb.) per 500' roll 4 mil high-density cross- laminated P.E. | Tape Required* Per Joint ft. |
|------------------|---------------------------------|--|---------------------------------|--|------------------------------------|
| | | Per 1000' of Tube | Per 22' Long Individual Tube | | |
| 4 | 14 | 89 | 2 | 21 | 5 |
| 6 | 16 | 102 | 3 | 24 | 6 |
| 8 | 20 | 128 | 3 | 30 | 8 |
| 10 | 24 | 154 | 4 | 36 | 9 |
| 12 | 27 | 173 | 4 | 40 | 10 |
| 14 | 30 | 192 | 5 | 45 | 11 |
| 16 | 34 | 218 | 5 | 51 | 12 |
| 18 | 37 | 237 | 6 | 55 | 13 |
| 20 | 41 | 262 | 6 | 61 | 15 |
| 24 | 54 | 346 | 8 | 80 | 17 |
| 30 | 67 | 429 | 10 | 100 | 21 |
| 36 | 81 | 518 | 12 | 120 | 25 |
| 42 | 81 | 518 | 12 | 120 | 28 |
| 48 | 95 | 608 | 14 | 141 | 32 |
| 54 | 108 | 689 | 16 | 161 | 35 |
| 60 | 108 | 689 | 16 | 161 | 36 |
| 64 | 121 | 772 | 18 | 180 | 39 |

*Based on one turn at each end, six 4"-long strips to secure loose wrap plus approximately 5% extra.
 †Flat tube widths are shown for Fastite, Flex-Ring, Lok-Ring, and MJ Joints. Check AMERICAN for Flat tube widths required for Flex-Lok Joints.
 The standard color for low-density polyethylene is black. It can also be furnished white, green, red, buff, royal blue, and lavender on special order. The standard color for high-density, cross-laminated polyethylene is white. It can also be furnished black on special order.

Installation of Polyethylene Encasement

Installment methods as set forth in ANSI/AWWA C105/A21.5 and DIPRA's "Polyethylene Encasement" brochure should be followed.

SECTION 12

AMERICAN Historical Data





AMERICAN Historical Data Obsolete Piping Materials

Cast iron pipe will often last for centuries. One evidence of this is the world's oldest known cast iron water mains which were installed to supply water to the town and parks of Versailles, France. This pipe provided continuous service for more than 300 years. However, changing requirements and improved manufacturing techniques have resulted in some piping materials' becoming obsolete. Although no longer manufactured, many piping materials continue in service, such as cast iron pipe with caulked bell and spigot joints which was one of the earliest types of joints used for underground service.

Over the years AMERICAN furnished millions of feet of gray cast iron pipe in sizes 2" through 48"; however, ductile iron has replaced gray iron in all of the pipe and fittings now being manufactured.

In ductile iron, like in gray cast iron, AMERICAN has continued to make improvements in joints and configurations, eliminating some joints in the process.

This section is included to furnish limited information pertaining to some of these obsolete materials. Contact AMERICAN for additional information if needed.

Note: When connecting to or repairing existing pipelines, it is good practice to carefully examine/measure the items involved prior to procuring materials and prior to commencing labor- and equipment-intensive operations. This would require at least minimal exposure of existing buried pipelines for identification and measurement. Likewise, all OSHA and other safety and governmental regulations should be complied with in such operations.



Cast Iron Pipe – being replaced by a larger main – is taken up after years of service for installation in another location for continued service.



Wall Thicknesses and Outside Diameters of Pit Cast Gray Iron Pipe

Table No. 12-1 **AWWA Standard**

| Size in. | Wall Thicknesses in Inches | | | | Outside Diameters in Inches | | | |
|----------|----------------------------|----------------------|----------------------|----------------------|-----------------------------|----------------------|----------------------|----------------------|
| | Class A 100 Ft. Head | Class B 200 Ft. Head | Class C 300 Ft. Head | Class D 400 Ft. Head | Class A 100 Ft. Head | Class B 200 Ft. Head | Class C 300 Ft. Head | Class D 400 Ft. Head |
| 4 | .42 | .45 | .48 | .52 | 4.80 | 5.00 | 5.00 | 5.00 |
| 6 | .44 | .48 | .51 | .55 | 6.90 | 7.10 | 7.10 | 7.10 |
| 8 | .46 | .51 | .56 | .60 | 9.05 | 9.05 | 9.30 | 9.30 |
| 10 | .50 | .57 | .62 | .68 | 11.10 | 11.10 | 11.40 | 11.40 |
| 12 | .54 | .62 | .68 | .75 | 13.20 | 13.20 | 13.50 | 13.50 |
| 14 | .57 | .66 | .74 | .82 | 15.30 | 15.30 | 15.65 | 15.65 |
| 16 | .60 | .70 | .80 | .89 | 17.40 | 17.40 | 17.80 | 17.80 |
| 18 | .64 | .75 | .87 | .96 | 19.50 | 19.50 | 19.92 | 19.92 |
| 20 | .67 | .80 | .92 | 1.03 | 21.60 | 21.60 | 22.06 | 22.06 |
| 24 | .76 | .89 | 1.04 | 1.16 | 25.80 | 25.80 | 26.32 | 26.32 |
| 30 | .88 | 1.03 | 1.20 | 1.37 | 31.74 | 32.00 | 32.40 | 32.74 |
| 36 | .99 | 1.15 | 1.36 | 1.58 | 37.96 | 38.30 | 38.70 | 39.16 |
| 42 | 1.10 | 1.28 | 1.54 | 1.78 | 44.20 | 44.50 | 45.10 | 45.58 |
| 48 | 1.26 | 1.42 | 1.71 | 1.96 | 50.50 | 50.80 | 51.40 | 51.98 |
| 54 | 1.35 | 1.55 | 1.90 | 2.23 | 56.66 | 57.10* | 57.80 | 58.40 |
| 60 | 1.39 | 1.67 | 2.00 | 2.38 | 62.80 | 63.40 | 64.20 | 64.82 |
| 72 | 1.62 | 1.95 | 2.39 | - | 75.34 | 76.00 | 76.88 | - |
| 84 | 1.72 | 2.22 | - | - | 87.54 | 88.54 | - | - |

* In the time frame from the mid-1960s-1988, AMERICAN also produced centrifugally cast Fastite and various push-on restrained-joint ductile iron pipes with a 57.10" nominal barrel O.D. (see Tables 12-13,14). This specific O.D. 54" ductile iron pipe is no longer produced, and modern 54" pipe has a 57.56" nominal O.D.

AMERICAN Mono-Cast Gray Iron Pipe Standard Laying Conditions

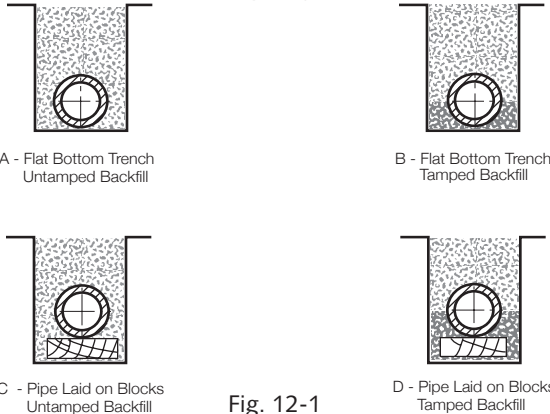

Fig. 12-1

In the 1970 Revision of ANSI A21.6 and A21.8, laying conditions "C" and "D" were deleted and laying condition "F" was added. See below.

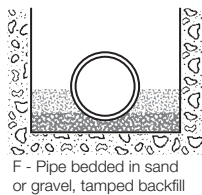

Fig. 12-2



AMERICAN Mono-Cast Bell and Spigot Gray Iron Pipe Centrifugally Cast in Sand-Lined Molds ANSI A21.8 (AWWA C108) Standard

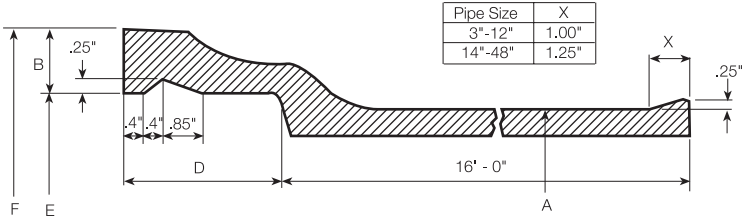

Table No. 12-2

| Size in. | A in. | Pattern | Dimensions in Inches | | | |
|----------|-------|---------|----------------------|------|-------|-------|
| | | | B | D | E | F |
| 3 | 3.96 | BCD | 1.25 | 3.50 | 4.76 | 7.26 |
| 4 | 4.80 | A | 1.30 | 3.50 | 5.60 | 8.20 |
| 4 | 5.00 | BCD | 1.30 | 3.50 | 5.80 | 8.40 |
| 6 | 6.90 | A | 1.35 | 3.50 | 7.70 | 10.40 |
| 6 | 7.10 | BCD | 1.35 | 3.50 | 7.90 | 10.60 |
| 8 | 9.05 | AB | 1.45 | 4.00 | 9.85 | 12.75 |
| 8 | 9.30 | CD | 1.45 | 4.00 | 10.10 | 13.00 |
| 10 | 11.10 | AB | 1.55 | 4.00 | 11.90 | 15.00 |
| 10 | 11.40 | CD | 1.55 | 4.00 | 12.20 | 15.30 |
| 12 | 13.20 | AB | 1.60 | 4.00 | 14.00 | 17.20 |
| 12 | 13.50 | CD | 1.60 | 4.00 | 14.30 | 17.50 |
| 14 | 15.30 | AB | 1.70 | 4.00 | 16.10 | 19.50 |
| 14 | 15.65 | CD | 1.70 | 4.00 | 16.45 | 19.85 |
| 16 | 17.40 | AB | 1.75 | 4.00 | 18.40 | 21.90 |
| 16 | 17.80 | CD | 1.75 | 4.00 | 18.80 | 22.30 |
| 18 | 19.50 | AB | 1.80 | 4.00 | 20.50 | 24.10 |
| 18 | 19.92 | CD | 1.80 | 4.00 | 20.92 | 24.52 |
| 20 | 21.60 | AB | 1.90 | 4.00 | 22.60 | 26.40 |
| 20 | 22.06 | CD | 1.90 | 4.00 | 23.06 | 26.86 |
| 24 | 25.80 | AB | 2.05 | 4.00 | 26.80 | 30.90 |
| 24 | 26.32 | CD | 2.05 | 4.00 | 27.32 | 31.42 |
| 30 | 32.00 | B | 2.25 | 4.50 | 33.00 | 37.50 |
| 36 | 38.30 | B | 2.45 | 4.50 | 39.30 | 44.20 |
| 42 | 44.50 | B | 2.65 | 5.00 | 45.50 | 50.80 |
| 48 | 50.80 | B | 2.85 | 5.00 | 51.80 | 57.50 |

AMERICAN Mono-Cast Bell and Spigot Gray Iron Pipe was also manufactured in accordance with Federal Specification WW-P-421 in sizes 4" through 24" Class 150 and Class 250. The standard outside diameter was "CD" pattern for 14" through 24" pipe. Alternate "AB" pattern pipe in these sizes and "B" pattern pipe in 30" through 48" sizes were also produced.

Pressure class thicknesses per ANSI A21.8 (AWWA C108) were the same as for those shown for Mechanical Joint Pipe in Table Nos. 12-8 and 12-9.

Weight of Lead and Jute Per Joint—AWWA

Table No. 12-3

| Size in. | Lead lb. | Jute lb. | Size in. | Lead lb. | Jute lb. | Size in. | Lead lb. | Jute lb. |
|----------|----------|----------|----------|----------|----------|----------|----------|----------|
| 3 | 6.50 | .18 | 14 | 24.00 | .81 | 36 | 77.25 | 3.00 |
| 4 | 8.00 | .21 | 16 | 33.00 | .94 | 42 | 104.25 | 3.50 |
| 6 | 11.25 | .31 | 18 | 36.90 | 1.00 | 48 | 119.00 | 4.00 |
| 8 | 14.50 | .44 | 20 | 40.50 | 1.25 | 54 | 133.00 | 5.60 |
| 10 | 17.50 | .53 | 24 | 52.50 | 1.50 | 60 | 148.00 | 6.20 |
| 12 | 20.50 | .61 | 30 | 64.75 | 2.06 | - | - | - |

AMERICAN HISTORICAL DATA — OBSOLETE PIPING MATERIALS



AMERICAN Gray Iron Fastite Joint Pipe
ANSI/AWWA C111/A21.11
Standard Dimensions

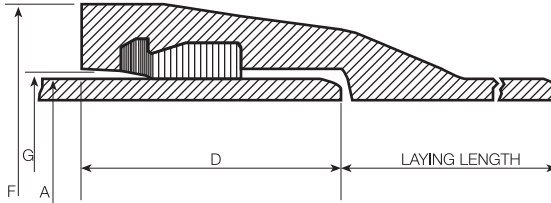

Table No. 12-4

| Size in. | Laying Length ft.-in. | Dimensions in Inches | | | |
|----------|-----------------------|----------------------|-------------------|---------------------|-------------|
| | | A Outside Diameter | D Depth of Socket | F Bell O.D. Maximum | G Bell I.D. |
| 3 | 20' - 0" | 3.96 | 3.00 | 6.08 | 4.07 |
| 4 | 20' - 0" | 4.80 | 3.31 | 7.13 | 4.91 |
| 6 | 20' - 0" | 6.90 | 3.38 | 9.19 | 7.01 |
| 8 | 20' - 0" | 9.05 | 3.75 | 11.50 | 9.16 |
| 10 | 20' - 0" | 11.10 | 3.75 | 13.75 | 11.21 |
| 12 | 20' - 0" | 13.20 | 3.75 | 15.75 | 13.31 |

For trim pipe allowance see AWWA C106.

AMERICAN Gray Iron Mechanical Joint Pipe
ANSI/AWWA C111/A21.11
Standard Dimensions

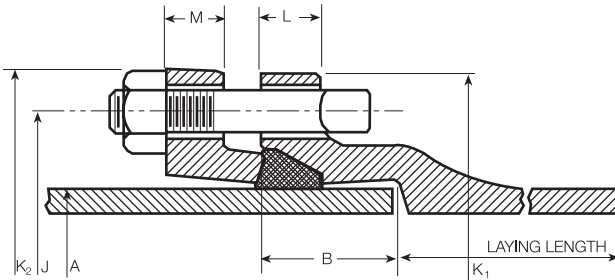

Table No. 12-5

| Size in. | Laying Length ft.-in. | Dimensions in Inches | | | | | | | Bolts | |
|----------|-----------------------|----------------------|-----|-------|----------------|----------------|------|------|---------------|-------------|
| | | A | B | J | K ₁ | K ₂ | L | M | No. Per Joint | Size in. |
| 3 | 20' - 1" | 3.96 | 2.5 | 6.19 | 7.62 | 7.69 | .94 | .62 | 4 | 3/8 X 3 |
| 4 | 20' - 1" | 4.80 | 2.5 | 7.50 | 9.06 | 9.12 | 1.00 | .75 | 4 | 3/8 X 3 1/2 |
| 6 | 20' - 1" | 6.90 | 2.5 | 9.50 | 11.06 | 11.12 | 1.06 | .88 | 6 | 3/8 X 3 1/2 |
| 8 | 20' - 1" | 9.05 | 2.5 | 11.75 | 13.31 | 13.37 | 1.12 | 1.00 | 6 | 3/8 X 4 |
| 10 | 20' - 1" | 11.10 | 2.5 | 14.00 | 15.62 | 15.62 | 1.19 | 1.00 | 8 | 3/8 X 4 |
| 12 | 20' - 1" | 13.20 | 2.5 | 16.25 | 17.88 | 17.88 | 1.25 | 1.00 | 8 | 3/8 X 4 |

For trim pipe allowance see AWWA C106.



AMERICAN Gray Iron Pipe ANSI/AWWA C106/A21.6 Standard Thickness Classes

Table No. 12-6

| Size in. | STANDARD CLASSES—Thickness in Inches | | | | | | | | | | |
|----------|--------------------------------------|------------|------------|------|------|------|------|------|------|------|------|
| | 20 | 21 | 22 | 23 | 24 | 25 | 26 | 27 | 28 | 29 | 30 |
| 3 | - | - | .32 | .35 | .38 | .41 | .44 | .48 | .52 | .56 | .60 |
| 4 | - | .32 | .35 | .38 | .41 | .44 | .48 | .52 | .56 | .60 | .65 |
| 6 | .32 | .35 | .38 | .41 | .44 | .48 | .52 | .56 | .60 | .65 | .70 |
| 8 | .35 | .38 | .41 | .44 | .48 | .52 | .56 | .60 | .65 | .70 | .76 |
| 10 | .38 | .41 | .44 | .48 | .52 | .56 | .60 | .65 | .70 | .76 | .82 |
| 12 | .41 | .44 | .48 | .52 | .56 | .60 | .65 | .70 | .76 | .82 | .89 |
| 14 | .43 | .48 | .51 | .55 | .59 | .64 | .69 | .75 | .81 | .87 | .94 |
| 16 | .46 | .50 | .54 | .58 | .63 | .68 | .73 | .79 | .85 | .92 | .99 |
| 18 | .50 | .54 | .58 | .63 | .68 | .73 | .79 | .85 | .92 | .99 | 1.07 |
| 20 | .53 | .57 | .62 | .67 | .72 | .78 | .84 | .91 | .98 | 1.06 | 1.14 |
| 24 | .58 | .63 | .68 | .73 | .79 | .85 | .92 | .99 | 1.07 | 1.16 | 1.25 |
| 30 | .68 | .73 | .79 | .85 | .92 | .99 | 1.07 | 1.16 | 1.25 | 1.35 | 1.46 |
| 36 | .75 | .81 | .87 | .94 | 1.02 | 1.10 | 1.19 | 1.29 | 1.39 | 1.50 | 1.62 |
| 42 | .83 | .90 | .97 | 1.05 | 1.13 | 1.22 | 1.32 | 1.43 | 1.54 | 1.66 | 1.79 |
| 48 | .91 | .98 | 1.06 | 1.14 | 1.23 | 1.33 | 1.44 | 1.56 | 1.68 | 1.81 | 1.95 |

Bold face figures indicate minimum Class thicknesses for 18/40 iron strength in accordance with AWWA C106. Thicknesses shown for Classes 20 and 21 were regularly furnished by AMERICAN in higher (21/45) iron strength, designed by the standard AWWA C101 method.
 Calculated thicknesses, based on design conditions, were adjusted to the nearest Class thickness, or to the minimum Class thickness if below specified minimum thickness.

AMERICAN HISTORICAL DATA — OBSOLETE PIPING MATERIALS



AMERICAN Gray Iron Fastite Joint and Mechanical Joint Pipe
ANSI/AWWA C106/A21.6

**WORKING PRESSURES
Standard Thicknesses and Weights**
3"-12" Sizes

These Classes of pipe were for water or other liquids for pipe under 5 feet of cover, laying condition "B" (see Fig.12-1) and for iron strengths indicated.
Table No. 12-7

| Size in. | 18/40 Iron | | | | | | 21/45 Iron | | | | | | |
|---------------------------------|--------------------|-----------------|--------------------|----------------------------------|---------------------------------|--------------------|-----------------|--------------------|----------------------------------|---------------------------------|------|------|------|
| | Wall Thickness In. | Thickness Class | Weight in Pounds | | | Wall Thickness In. | Thickness Class | Weight in Pounds | | | | | |
| | | | Per Foot Plain End | FASTITE JOINT Per Foot Incl.Bell | MECHANICAL JOINT Per 20' Length | | | Per Foot Plain End | FASTITE JOINT Per Foot Incl.Bell | MECHANICAL JOINT Per 20' Length | | | |
| 50 psi Working Pressure | | | | | | | | | | | | | |
| 3 | .32 | 22 | 11.4 | 240 | 11.9 | .32 | 22 | 11.4 | 240 | 11.9 | 240 | 11.9 | 240 |
| 4 | .35 | 22 | 15.3 | 320 | 16.1 | .35 | 22 | 15.3 | 320 | 16.0 | 320 | 16.1 | 320 |
| 6 | .38 | 22 | 24.3 | 510 | 25.4 | .35 | 21 | 22.5 | 475 | 23.8 | 475 | 23.6 | 470 |
| 8 | .41 | 22 | 34.7 | 735 | 36.2 | .38 | 20 | 29.8 | 635 | 31.8 | 635 | 31.3 | 625 |
| 10 | .44 | 22 | 46.0 | 975 | 48.0 | .38 | 20 | 39.9 | 850 | 42.6 | 850 | 41.9 | 840 |
| 12 | .48 | 22 | 59.8 | 1260 | 62.3 | .41 | 20 | 51.4 | 1095 | 54.7 | 1095 | 53.9 | 1080 |
| 100 psi Working Pressure | | | | | | | | | | | | | |
| 3 | .32 | 22 | 11.4 | 240 | 11.9 | .32 | 22 | 11.4 | 240 | 11.9 | 240 | 11.9 | 240 |
| 4 | .35 | 22 | 15.3 | 320 | 16.1 | .35 | 22 | 15.3 | 320 | 16.0 | 320 | 16.1 | 320 |
| 6 | .38 | 22 | 24.3 | 510 | 25.4 | .35 | 21 | 22.5 | 475 | 23.8 | 475 | 23.6 | 470 |
| 8 | .41 | 22 | 34.7 | 735 | 36.2 | .38 | 20 | 29.8 | 635 | 31.8 | 635 | 31.3 | 625 |
| 10 | .44 | 22 | 46.0 | 975 | 48.0 | .38 | 20 | 39.9 | 850 | 42.6 | 850 | 41.9 | 840 |
| 12 | .48 | 22 | 59.8 | 1260 | 62.3 | .41 | 20 | 51.4 | 1095 | 54.7 | 1095 | 53.9 | 1080 |
| 150 psi Working Pressure | | | | | | | | | | | | | |
| 3 | .32 | 22 | 11.4 | 240 | 11.9 | .32 | 22 | 11.4 | 240 | 11.9 | 240 | 11.9 | 240 |
| 4 | .35 | 22 | 15.3 | 320 | 16.1 | .35 | 22 | 15.3 | 320 | 16.0 | 320 | 16.1 | 320 |
| 6 | .38 | 22 | 24.3 | 510 | 25.4 | .35 | 21 | 22.5 | 475 | 23.8 | 475 | 23.6 | 470 |
| 8 | .41 | 22 | 34.7 | 735 | 36.2 | .38 | 20 | 29.8 | 635 | 31.8 | 635 | 31.3 | 625 |
| 10 | .44 | 22 | 46.0 | 975 | 48.0 | .38 | 20 | 39.9 | 850 | 42.6 | 850 | 41.9 | 840 |
| 12 | .48 | 22 | 59.8 | 1260 | 62.3 | .41 | 20 | 51.4 | 1095 | 54.7 | 1095 | 53.9 | 1080 |

The 18/40 iron strength was per AWWA C106. The design details and standard thicknesses for pipe with 21/45 iron strength were covered in AWWA C101. The minimum thickness gray cast iron normally furnished in 4" size was .35" wall thickness (Class 22), and in 6" was .35" wall thickness (Class 21).



AMERICAN Gray Iron Fastite Joint and Mechanical Joint Pipe ANSI/AWWA C106/A21.6 WORKING PRESSURES Standard Thicknesses and Weights 3"-12" Sizes

These Classes of pipe were for water or other liquids for pipe under 5 feet of cover, laying condition "B" (see Fig.12-1) and for iron strengths indicated.

Table No. 12-7 -Continued

| Size in. | 18/40 Iron | | | | | | 21/45 Iron | | | | | | | |
|---------------------------------|--------------------|------------------|----------------------------------|----------------|--------------------|---------------------|------------------|----------------------------------|----------------|-------------------------------------|--------------------|------------------|------|------|
| | Wall Thickness in. | Thick-ness Class | Weight in Pounds | | | Wall Thick-ness in. | Thick-ness Class | Weight in Pounds | | | Per Foot Plain End | MECHANICAL JOINT | | |
| | | | FASTITE JOINT Per Foot Incl.Bell | Per 20' Length | Per Foot Incl.Bell | | | FASTITE JOINT Per Foot Incl.Bell | Per 20' Length | MECHANICAL JOINT Per Foot Incl.Bell | | Per 20' Length | | |
| 200 psi Working Pressure | | | | | | | | | | | | | | |
| 3 | .32 | 22 | 11.4 | 240 | 11.9 | .32 | 22 | 11.4 | 240 | 11.9 | 11.4 | 240 | 11.9 | 240 |
| 4 | .35 | 22 | 15.3 | 320 | 16.1 | .35 | 22 | 15.3 | 320 | 16.0 | 15.3 | 320 | 16.1 | 320 |
| 6 | .38 | 22 | 24.3 | 510 | 25.4 | .35 | 21 | 22.5 | 475 | 23.8 | 22.5 | 475 | 23.6 | 470 |
| 8 | .41 | 22 | 34.7 | 735 | 36.2 | .35 | 20 | 29.8 | 635 | 31.8 | 29.8 | 635 | 31.3 | 625 |
| 10 | .44 | 22 | 46.0 | 975 | 48.0 | .41 | 21 | 43.0 | 915 | 45.7 | 43.0 | 915 | 45.0 | 900 |
| 12 | .48 | 22 | 59.8 | 1260 | 62.3 | .44 | 21 | 55.0 | 1165 | 58.3 | 55.0 | 1165 | 57.5 | 1150 |
| 250 psi Working Pressure | | | | | | | | | | | | | | |
| 3 | .32 | 22 | 11.4 | 240 | 11.9 | .32 | 22 | 11.4 | 240 | 11.9 | 11.4 | 240 | 11.9 | 240 |
| 4 | .35 | 22 | 15.3 | 320 | 16.1 | .35 | 22 | 15.3 | 320 | 16.0 | 15.3 | 320 | 16.1 | 320 |
| 6 | .38 | 22 | 24.3 | 510 | 25.4 | .35 | 21 | 22.5 | 475 | 23.8 | 22.5 | 475 | 23.6 | 470 |
| 8 | .41 | 22 | 34.7 | 735 | 36.2 | .35 | 20 | 29.8 | 635 | 31.8 | 29.8 | 635 | 31.3 | 625 |
| 10 | .44 | 22 | 46.0 | 975 | 48.0 | .41 | 21 | 43.0 | 915 | 45.7 | 43.0 | 915 | 45.0 | 900 |
| 12 | .52 | 23 | 64.6 | 1360 | 67.1 | .48 | 22 | 59.8 | 1260 | 63.1 | 59.8 | 1260 | 62.3 | 1245 |

The 18/40 iron strength was per AWWA C106. The design details and standard thicknesses for pipe with 21/45 iron strength were covered in AWWA C101. The minimum thickness gray cast iron normally furnished in 4" size was .35" wall thickness (Class 22), and in 6" was .35" wall thickness (Class 21).



**AMERICAN Mono-Cast Mechanical Joint Gray Iron Pipe
Centrifugally Cast in Sand-Lined Molds
14" - 48" Sizes
ANSI A21.8 (AWWA C108) Standard**

These Classes of pipe were for water service and other liquids under 5 feet of cover, laying condition "B" (flat bottom trench with tamped backfill), and for iron strengths indicated.

Table No. 12-8

| Size in. | Outside Diameter in. | 18/40 IRON | | | | 21/45 IRON | | | |
|---------------------------------|----------------------|------------------|--------------------|---------------------|--------------------|----------------------|--------------------|---------------------|--------------------|
| | | Thick-ness in. | Weight in Pounds | | | Thick-ness in. | Weight in Pounds | | |
| | | | Per Foot Plain End | Per Foot incl. Bell | Per 16-Foot Length | | Per Foot Plain End | Per Foot incl. Bell | Per 16-Foot Length |
| 100 PSI Working Pressure | | CLASS 100 | | | | 231 Feet Head | | | |
| 14 | 15.30 | .51 | 73.9 | 78.8 | 1260 | .48 | 69.7 | 74.6 | 1195 |
| 16 | 17.40 | .54 | 89.2 | 95.0 | 1520 | .50 | 82.8 | 88.7 | 1420 |
| 18 | 19.50 | .58 | 107.6 | 114.7 | 1835 | .54 | 100.4 | 107.5 | 1720 |
| 20 | 21.60 | .62 | 127.5 | 135.9 | 2175 | .57 | 117.5 | 125.9 | 2015 |
| 24 | 25.80 | .68 | 167.4 | 178.5 | 2855 | .63 | 155.4 | 166.5 | 2665 |
| 30 | 32.00 | .79 | 241.7 | 259.5 | 4150 | .79 | 241.7 | 259.5 | 4150 |
| 36 | 38.30 | .87 | 319.2 | 343.9 | 5500 | .87 | 319.2 | 343.9 | 5500 |
| 42 | 44.50 | .97 | 413.9 | 445.7 | 7130 | .90 | 384.6 | 416.5 | 6665 |
| 48 | 50.80 | 1.06 | 516.8 | 557.1 | 8915 | 1.06 | 516.8 | 557.1 | 8915 |
| 150 PSI Working Pressure | | CLASS 150 | | | | 346 Feet Head | | | |
| 14 | 15.30 | .51 | 73.9 | 78.8 | 1260 | .48 | 69.7 | 74.6 | 1195 |
| 16 | 17.40 | .54 | 89.2 | 95.0 | 1520 | .54 | 89.2 | 95.0 | 1520 |
| 18 | 19.50 | .58 | 107.6 | 114.7 | 1835 | .58 | 107.6 | 114.7 | 1835 |
| 20 | 21.60 | .62 | 127.5 | 135.9 | 2175 | .62 | 127.5 | 135.9 | 2175 |
| 24 | 25.80 | .73 | 179.4 | 190.4 | 3045 | .68 | 167.4 | 178.5 | 2855 |
| 30 | 32.00 | .85 | 259.5 | 277.3 | 4435 | .79 | 241.7 | 259.5 | 4150 |
| 36 | 38.30 | .94 | 344.2 | 368.9 | 5900 | .87 | 319.2 | 343.9 | 5500 |
| 42 | 44.50 | 1.05 | 447.2 | 479.1 | 7665 | .97 | 413.9 | 445.7 | 7130 |
| 48 | 50.80 | 1.14 | 554.9 | 595.2 | 9525 | 1.06 | 516.8 | 557.1 | 8915 |
| 250 PSI Working Pressure | | CLASS 250 | | | | 577 Feet Head | | | |
| 14 | 15.30 | .59 | 85.1 | 90.0 | 1440 | .55 | 79.5 | 84.4 | 1350 |
| 16 | 17.40 | .63 | 103.6 | 109.6 | 1755 | .58 | 95.6 | 101.5 | 1625 |
| 18 | 19.50 | .68 | 125.4 | 132.5 | 2120 | .63 | 116.5 | 123.5 | 1975 |
| 20 | 21.60 | .72 | 147.4 | 155.7 | 2490 | .67 | 137.5 | 145.9 | 2335 |
| 24 | 25.80 | .79 | 193.7 | 204.8 | 3275 | .79 | 193.7 | 204.8 | 3275 |
| 30 | 32.00 | .99 | 300.9 | 318.7 | 5100 | .85 | 259.5 | 277.3 | 4435 |
| 36 | 38.30 | 1.10 | 401.1 | 425.8 | 6815 | 1.02 | 372.7 | 397.4 | 6360 |
| 42 | 44.50 | 1.22 | 517.6 | 549.5 | 8790 | 1.13 | 480.4 | 512.3 | 8195 |
| 48 | 50.80 | 1.33 | 644.9 | 685.2 | 10965 | 1.23 | 597.6 | 637.9 | 10205 |

Iron of 18/40 strength was in accordance with ANSI A21.8.

Iron of 21/45 strength was AMERICAN standard with thicknesses designed by the standard ANSI method.

AMERICAN furnished 14" through 24" Gray Iron Pipe in nominal 20-foot lengths for several years prior to discontinuing manufacture of Gray Iron Pipe in these sizes.

AMERICAN currently manufactures Mechanical Joint ductile iron pipe in sizes 4" through 24". See Section 3.



**AMERICAN Fastite Joint Gray Iron Pipe
Centrifugally Cast in Sand-Lined Molds**
14"-48" Sizes
**ANSI A21.8 (AWWA C108) Standard
Federal Specification WW-P-421c**

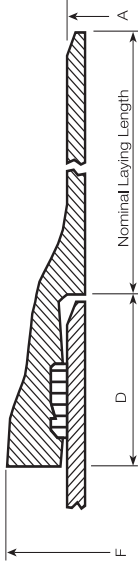

Table No. 12-9

| Size in. | Nominal Laying Length ft. | A O.D. in. | D Socket Depth in. | F Bell O.D. Max. in. | Class 150 — 18/40 Iron | | | | Class 150 — 21/45 Iron | | | |
|----------|---------------------------|------------|--------------------|----------------------|------------------------|--------------------|---------------------|-----------------|------------------------|--------------------|---------------------|-----------------|
| | | | | | Wall Thickness in. | Weight in Pounds | | | Wall Thickness in. | Weight in Pounds | | |
| | | | | | | Per Foot Plain End | Per Foot Incl. Bell | Per Foot Length | | Per Foot Plain End | Per Foot Incl. Bell | Per Foot Length |
| 14 | 20 | 15.30 | 4.50 | 19.68 | .51 | 73.9 | 77.8 | 1555 | .48 | 69.7 | 73.7 | 1475 |
| 16 | 20 | 17.40 | 4.50 | 21.68 | .54 | 89.2 | 94.0 | 1880 | .54 | 89.2 | 94.0 | 1880 |
| 18 | 20 | 19.50 | 4.50 | 23.88 | .58 | 107.6 | 113.3 | 2265 | .58 | 107.6 | 113.3 | 2265 |
| 20 | 20 | 21.60 | 4.75 | 26.31 | .62 | 127.5 | 134.2 | 2685 | .62 | 127.5 | 134.2 | 2685 |
| 24 | 20 | 25.80 | 4.75 | 29.90 | .73 | 179.4 | 188.0 | 3760 | .68 | 167.4 | 176.0 | 3520 |
| 30 | 16 | 32.00 | 5.25 | 37.31 | .85 | 259.5 | 274.8 | 4395 | .79 | 241.7 | 257.0 | 4110 |
| 36 | 16 | 38.30 | 5.25 | 43.75 | .94 | 344.2 | 363.5 | 5815 | .87 | 319.2 | 338.5 | 5415 |
| 42 | 16 | 44.50 | 5.25 | 49.38 | 1.05 | 447.2 | 472.2 | 7555 | .97 | 413.9 | 438.9 | 7020 |
| 48 | 16 | 50.80 | 5.25 | 56.19 | 1.14 | 554.9 | 583.0 | 9330 | 1.06 | 516.8 | 544.9 | 8720 |
| | | | | | Class 250 — 18/40 Iron | | | | Class 250 — 21/45 Iron | | | |
| 14 | 20 | 15.30 | 4.50 | 19.68 | .59 | 85.1 | 89.4 | 1790 | .55 | 79.5 | 83.4 | 1670 |
| 16 | 20 | 17.40 | 4.50 | 21.68 | .63 | 103.6 | 108.9 | 2180 | .58 | 95.6 | 100.4 | 2010 |
| 18 | 20 | 19.50 | 4.50 | 23.88 | .68 | 125.4 | 131.7 | 2635 | .63 | 116.5 | 122.2 | 2445 |
| 20 | 20 | 21.60 | 4.75 | 26.31 | .72 | 147.4 | 154.7 | 3095 | .67 | 137.5 | 144.2 | 2885 |
| 24 | 20 | 25.80 | 4.75 | 29.90 | .79 | 193.7 | 203.2 | 4065 | .73 | 179.4 | 183.0 | 3760 |
| 30 | 16 | 32.00 | 5.25 | 37.31 | .99 | 300.9 | 317.8 | 5085 | .85 | 259.5 | 274.8 | 4395 |
| 36 | 16 | 38.30 | 5.25 | 43.75 | 1.10 | 401.1 | 423.2 | 6770 | 1.02 | 372.7 | 394.8 | 6315 |
| 42 | 16 | 44.50 | 5.25 | 49.38 | 1.22 | 517.6 | 546.4 | 8740 | 1.13 | 480.4 | 509.2 | 8145 |
| 48 | 16 | 50.80 | 5.25 | 56.19 | 1.33 | 644.9 | 680.7 | 10890 | 1.23 | 597.6 | 633.4 | 10135 |

AMERICAN currently manufactures Fastite ductile iron pipe in sizes 4" through 64". See Section 3.

AMERICAN HISTORICAL DATA — OBSOLETE PIPING MATERIALS



**AMERICAN Mechanical Locked Joint
Centrifugally Cast Gray Iron Pipe**

AMERICAN Standard

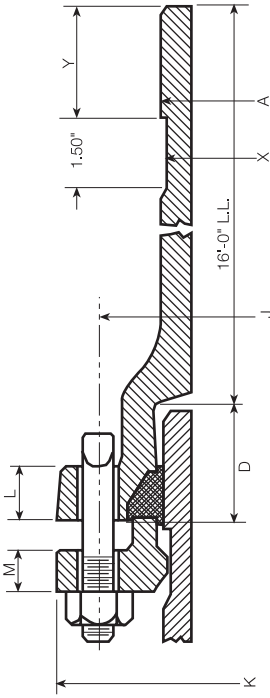

Table No. 12-10

| Size in. | Dimensions in Inches | | | | | | | | | | | Bolts | | | Safe End Pull in Tons |
|-------------|----------------------|-------|------|-------|-------|------|------|------|------------------|-------------|---------------|-------|--|--|-----------------------------|
| | A | X | D | K | J | M | L | Y | No. Per Joint | Size in. | Length in. | | | | |
| 3 | 3.96 | 3.71 | 2.50 | 7.69 | 6.19 | .62 | .94 | 2.62 | 4 | 3/4 | 3 | 10 | | | |
| 4 | 4.80 | 4.55 | 2.50 | 9.12 | 7.50 | .75 | 1.00 | 2.62 | 4 | 3/4 | 3 1/2 | 12 | | | |
| 6 | 6.90 | 6.65 | 2.50 | 11.12 | 9.50 | .88 | 1.06 | 2.62 | 6 | 3/4 | 3 1/2 | 17 | | | |
| 8 | 9.05 | 8.80 | 2.50 | 13.38 | 11.75 | 1.00 | 1.12 | 2.62 | 6 | 3/4 | 4 | 17 | | | |
| 10 | 11.10 | 10.85 | 2.50 | 15.62 | 14.00 | 1.00 | 1.19 | 2.62 | 8 | 3/4 | 4 | 23 | | | |
| 12 | 13.20 | 12.95 | 2.50 | 18.00 | 16.25 | 1.00 | 1.25 | 2.62 | 8 | 3/4 | 4 | 23 | | | |
| 14 | 15.30 | 15.05 | 3.50 | 20.25 | 18.75 | 1.25 | 1.31 | 3.62 | 10 | 3/4 | 4 | 29 | | | |
| 16 | 17.40 | 17.15 | 3.50 | 22.50 | 21.00 | 1.31 | 1.38 | 3.62 | 12 | 3/4 | 4 1/2 | 35 | | | |
| 18 | 19.50 | 19.25 | 3.50 | 24.75 | 23.25 | 1.38 | 1.44 | 3.62 | 12 | 3/4 | 4 1/2 | 35 | | | |
| 20 | 21.60 | 21.35 | 3.50 | 27.00 | 25.50 | 1.44 | 1.50 | 3.62 | 14 | 3/4 | 4 1/2 | 40 | | | |
| 24 | 25.80 | 25.55 | 3.50 | 31.50 | 30.00 | 1.56 | 1.62 | 3.62 | 16 | 3/4 | 5 | 46 | | | |
| 30 | 32.00 | 31.63 | 4.00 | 39.12 | 36.88 | 2.00 | 1.81 | 4.12 | 20 | 1 | 6 | 97 | | | |
| 36 | 38.30 | 37.93 | 4.00 | 46.00 | 43.75 | 2.00 | 2.00 | 4.12 | 24 | 1 | 6 | 114 | | | |
| 42 | 44.50 | 44.13 | 4.00 | 53.12 | 50.62 | 2.00 | 2.00 | 4.12 | 28 | 1 1/4 | 6 | 231 | | | |
| 48 | 50.80 | 50.43 | 4.00 | 60.00 | 57.50 | 2.00 | 2.00 | 4.12 | 32 | 1 1/4 | 6 | 269 | | | |

Pipe with AMERICAN Mechanical Locked Joints were furnished in a standard thickness class for a limited pressure rating varying with pipe size. For currently available restrained joints see Section 9.



AMERICAN Flanged Gray Iron Pipe ANSI A21.15 (AWWA C115) Standard

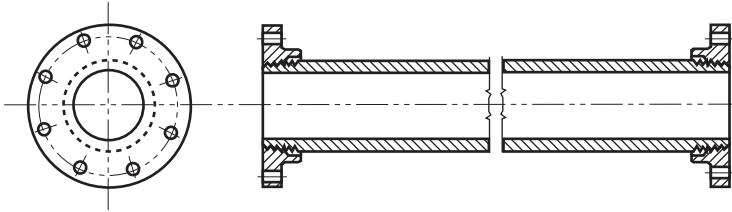

Table No. 12-11

| Size in. | Pressure Rating psi | Thick-ness Class | Wall Thick-ness in. | Pipe O.D. in. | Standard * Length ft.-in. | Weight in Pounds | | | | |
|----------|---------------------|------------------|---------------------|---------------|---------------------------|--------------------|-------------------|-----------------------------|--------------------|-----------------------------|
| | | | | | | Per Foot Plain End | ANSI A21.15 Flg** | | ANSI 250 B16.1 Flg | |
| | | | | | | | One Flange | Std. Lgth. Pipe With 2 Flgs | One Flange | Std. Lgth. Pipe With 2 Flgs |
| 2 | 250 | - | .38 | 2.75 | 11' - 6" | 8.8 | 4 | 110 | 7 | 115 |
| 3 | 250 | 24 | .38 | 3.96 | 11' - 6" | 13.3 | 7 | 165 | 12 | 175 |
| 4 | 250 | 23 | .38 | 4.80 | 19' - 6" | 16.5 | 13 | 350 | 20 | 360 |
| 6 | 250 | 22 | .38 | 6.90 | 19' - 6" | 24.3 | 17 | 510 | 34 | 540 |
| 8 | 250 | 22 | .41 | 9.05 | 19' - 6" | 34.7 | 27 | 730 | 50 | 775 |
| 10 | 250 | 22 | .44 | 11.10 | 19' - 6" | 46.0 | 38 | 975 | 70 | 1035 |
| 12 | 150 | 22 | .48 | 13.20 | 19' - 6" | 59.8 | 58 | 1280 | - | - |
| 12 | 250 | 23 | .52 | 13.20 | 19' - 6" | 64.6 | 58 | 1375 | 102 | 1465 |
| 14 | 150 | 22 | .51 | 15.30 | 20' - 0" | 73.9 | 72 | 1620 | - | - |
| 14 | 250 | 24 | .59 | 15.30 | 20' - 0" | 85.1 | 72 | 1845 | 130 | 1960 |
| 16 | 150 | 22 | .54 | 17.40 | 20' - 0" | 89.2 | 90 | 1965 | - | - |
| 16 | 250 | 24 | .63 | 17.40 | 20' - 0" | 103.6 | 90 | 2250 | 162 | 2395 |
| 18 | 150 | 22 | .58 | 19.50 | 20' - 0" | 107.6 | 90 | 2330 | - | - |
| 18 | 250 | 24 | .68 | 19.50 | 20' - 0" | 125.4 | 90 | 2690 | 200 | 2910 |
| 20 | 150 | 22 | .62 | 21.60 | 20' - 0" | 127.5 | 115 | 2780 | - | - |
| 20 | 250 | 24 | .72 | 21.60 | 20' - 0" | 147.4 | 115 | 3180 | 245 | 3440 |
| 24 | 150 | 23 | .73 | 25.80 | 20' - 0" | 179.4 | 160 | 3910 | - | - |
| 24 | 250 | 24 | .79 | 25.80 | 20' - 0" | 193.7 | 160 | 4195 | 370 | 4615 |
| 30 | 150 | 23 | .85 | 32.00 | 16' - 0" | 259.5 | 240 | 4630 | - | - |
| 30 | 250 | 25 | .99 | 32.00 | 16' - 0" | 300.9 | 240 | 5295 | 530 | 5875 |
| 36 | 150 | 23 | .94 | 38.30 | 16' - 0" | 344.2 | 350 | 6205 | - | - |
| 36 | 250 | 25 | 1.10 | 38.30 | 16' - 0" | 401.1 | 350 | 7120 | 710 | 7840 |
| 42 | 150 | 23 | 1.05 | 44.50 | 16' - 0" | 447.2 | 500 | 8155 | - | - |
| 42 | 250 | 25 | 1.22 | 44.50 | 16' - 0" | 517.6 | 500 | 9280 | 900 | 10080 |
| 48 | 150 | 23 | 1.14 | 50.80 | 16' - 0" | 554.9 | 625 | 10130 | - | - |
| 48 | 250 | 25 | 1.33 | 50.80 | 16' - 0" | 644.9 | 625 | 11570 | 1350 | 13020 |

*Tolerance on length was $\pm 1/16"$ for 2" through 10" sizes and $\pm 1/8"$ for 12" and larger.

**Standard drilling was for bolt holes to straddle centerline. Special drilling was furnished on request of purchaser. Flanges were not back faced unless specified.

Pressure rating designated in table above was maximum water working pressure.

AMERICAN HISTORICAL DATA — OBSOLETE PIPING MATERIALS



**AMERICAN Abrasion-Resistant Pipe
BHN 285 Minimum**

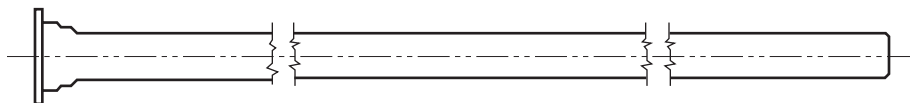

MJ and PE Pipe

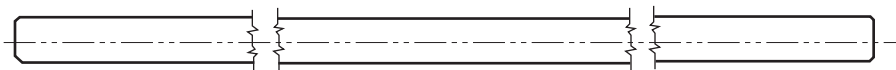

PE and PE Pipe

Table No. 12-12

| Size in. | O.D. in. | Thickness | | Nominal Laying Length* | |
|----------|----------|-------------|-------------|------------------------|-----------------|
| | | Minimum in. | Maximum in. | MJ & PE ft. | PE & PE ft.-in. |
| 6 | 6.90 | .32 | .55 | 20' | 19' - 6" |
| 8 | 9.05 | .35 | .65 | 20' | 19' - 6" |
| 10 | 11.10 | .38 | .68 | 20' | 19' - 6" |
| 12 | 13.20 | .41 | .70 | 20' | 19' - 6" |
| 14 | 15.30 | .43 | .70 | 20' | 19' - 6" |
| 16 | 17.40 | .46 | .70 | 20' | 19' - 6" |

*Laying lengths were nominal and were subject to trim variations.

Special O.D. pipe were available in some sizes.

Standard AWWA C151 thickness classes as well as special thicknesses between the minimum and maximum specified above, were furnished.

Lower or higher hardness grades were furnished. The higher grades were limited to plain end joints.

For field cuts of abrasive-resistant pipe, abrasive cut-off wheels are recommended.

**AMERICAN Ductile Iron Lok-Set Joint Pipe
Standard Dimensions**

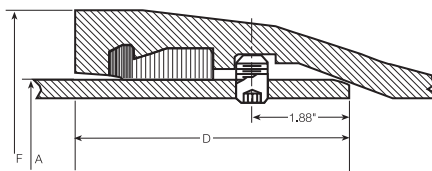

Table No. 12-13

| Size in. | Dimensions in Inches | | | Size Set Screws* in. | No. Set Screws Required for Internal Pressure | | |
|----------|----------------------|------|-------|----------------------|---|---------|---------|
| | A | D | F | | 100 psi | 150 psi | 200 psi |
| 24 | 25.80 | 5.75 | 29.94 | 3/4 x 1 1/4 | 6 | 10 | 12 |
| 30 | 32.00 | 6.50 | 35.75 | 3/4 x 1 1/4 | 8 | 12 | 16 |
| 36 | 38.30 | 6.50 | 42.25 | 7/8 x 1 1/4 | 10 | 16 | 20 |
| 42 | 44.50 | 6.50 | 48.00 | 7/8 x 1 1/4 | 12 | 18 | 24 |
| 48 | 50.80 | 6.50 | 54.56 | 7/8 x 1 1/4 | 14 | 20 | 28 |
| 54 | 57.10 | 6.50 | 61.44 | 7/8 x 1 1/4 | 16 | 24 | 32 |

*Stainless Steel, Type 416.

Minimum Class Ductile Iron Pipe for Lok-Set Joint 24" and 30" sizes was Class 51; for 36" - 54" sizes was Class 50. Nominal laying length — which was subject to trim allowance — was 20'. If exact lengths were required figure 19'-11" for 24" and 18' for 30" - 54". See Section 3 for weights.

Either Lok-Set Joint fittings or Lok-Fast Joint fittings were normally furnished for installation with Lok-Set Joint Pipe. A pipe with combination of Lok-Set bell and Lok-Fast gland end facilitated the use of Lok-Fast fittings.



AMERICAN Ductile Iron Lok-Fast Joint Pipe Standard Dimensions

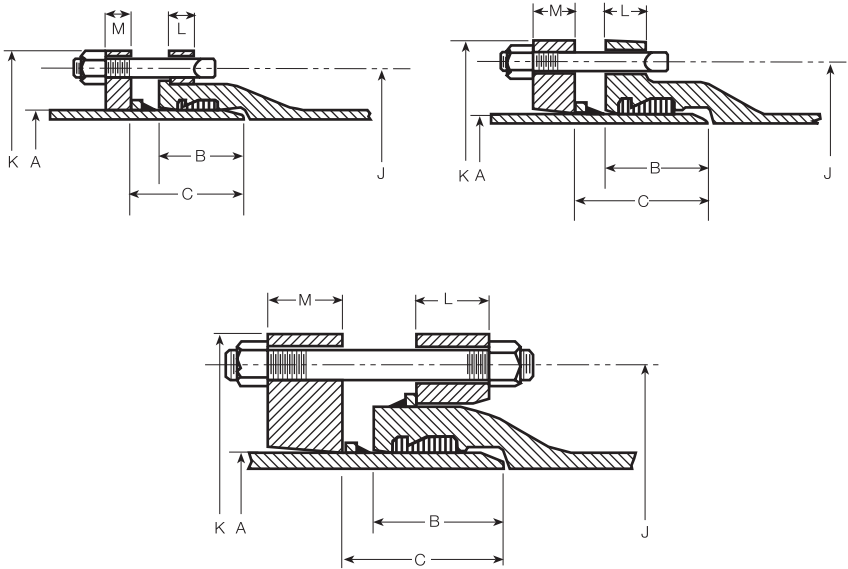

Table No. 12-14

1-80000

| Size in. | A Outside Diameter in. | Nominal Laying Length ft.-in. | B Socket Depth in. | C Plain End to Gland in. | J Bolt Circle in. | K O.D.Gland and Flange in. | Thickness of Flange and Gland | |
|-------------|---------------------------------|--|-----------------------------|-----------------------------------|----------------------------|--|----------------------------------|----------|
| | | | | | | | L in. | M in. |
| 4 | 4.80 | 20 | 3.31 | 4.03 | 8.06 | 9.56 | .75 | .75 |
| 6 | 6.90 | 20 | 3.38 | 4.25 | 10.25 | 11.75 | .87 | .87 |
| 8 | 9.05 | 20 | 3.75 | 4.56 | 12.50 | 14.00 | 1.00 | 1.00 |
| 10 | 11.10 | 20 | 3.75 | 4.62 | 14.69 | 16.19 | 1.00 | 1.00 |
| 12 | 13.20 | 20 | 3.75 | 4.62 | 16.75 | 18.25 | 1.00 | 1.00 |
| 14 | 15.30 | 20 | 5.23 | 6.00 | 18.75 | 20.50 | 1.00 | 1.50 |
| 16 | 17.40 | 20 | 5.23 | 6.00 | 21.00 | 22.75 | 1.12 | 1.56 |
| 18 | 19.50 | 20 | 5.50 | 6.75 | 23.25 | 25.12 | 1.12 | 1.62 |
| 20 | 21.60 | 20 | 5.50 | 6.75 | 25.50 | 27.38 | 1.25 | 1.69 |
| 24 | 25.80 | 20 | 5.50 | 6.75 | 30.00 | 31.88 | 1.25 | 1.81 |
| 30 | 32.00 | 20 | 6.50 | 7.25 | 36.88 | 39.12 | 1.50 | 2.25 |
| 36 | 38.30 | 20 | 6.50 | 7.25 | 43.75 | 46.00 | 1.63 | 2.44 |
| 42 | 44.50 | 20 | 4.75 | 6.00 | 50.62 | 53.12 | 1.50 | 2.62 |
| 48 | 50.80 | 20 | 4.75 | 6.00 | 57.50 | 60.00 | 1.50 | 2.81 |
| 54 | 57.10 | 20 | 5.25 | 6.50 | 64.38 | 66.88 | 3.00 | 3.00 |

Center-to-socket dimensions for Lok-Fast fittings were normally the same as those for Mechanical Joint fittings.

Socket depths of 14"-36" Lok-Fast fittings differed from those shown above.

The dimensions for 42"-54" Lok-Fast Pipe were, where applicable, the same for Lok-Fast fittings.

Lok-Fast joints were made in the various configurations shown in various combination of diameters. Dimensions in this table relate to a certain combination of diameters and configurations and may not apply to other combinations.



AMERICAN Ductile Iron Threaded Joint Pipe with Ductile Couplings

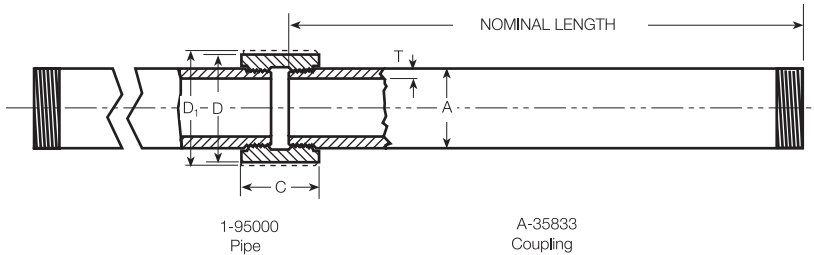

AMERICAN Ductile Iron Threaded Joint Pipe offered several advantages over other pipe materials, namely, long life, uniformity of product, high physical strength properties, and easy threading.

Table No. 12-15

| Size in. | A in. | T Wall Thickness in. | Pipe—1-95000 | | Coupling—A-35833 | | | Weight lb |
|----------|-------|----------------------|------------------|------------|----------------------|-------|---------------------------|-----------|
| | | | Weight in Pounds | | Dimensions in Inches | | | |
| | | | Per Foot | Per 19'-6" | C | D | D ₁ Over-Ribs* | |
| 4 | 4.80 | .32 | 13.8 | 270 | 4.00 | 5.75 | 6.00 | 10 |
| 6 | 6.90 | .34 | 21.4 | 415 | 4.50 | 7.88 | 8.12 | 16 |
| 8 | 9.05 | .36 | 30.1 | 585 | 5.00 | 10.12 | 10.38 | 25 |
| 10 | 11.10 | .38 | 39.2 | 765 | 5.25 | 12.50 | 12.75 | 40 |
| 12 | 13.20 | .40 | 49.2 | 960 | 5.75 | 14.62 | 14.88 | 55 |
| 14 | 15.30 | .42 | 60.1 | 1170 | 6.25 | 16.88 | 17.12 | 75 |
| 16 | 17.40 | .43 | 70.1 | 1365 | 6.75 | 19.25 | 19.50 | 110 |
| 18 | 19.50 | .44 | 80.6 | 1570 | 7.00 | 21.38 | 21.62 | 125 |
| 20 | 21.60 | .45 | 91.5 | 1785 | 7.50 | 23.62 | 23.88 | 155 |
| 24 | 25.80 | .47 | 114.4 | 2230 | 8.25 | 28.12 | 28.38 | 235 |

*Ribs were furnished on couplings only when specified.

Special threading and long couplings could be furnished as desired. Tabulated wall thicknesses are special Class 53; heavier wall thicknesses could be furnished. Maximum length was 19' - 6".

Design was for 250 psi water working pressure.

"D" dimension on coupling had normal tolerance of ± 0.12 ".

Threaded Joint Pipe was furnished to the applicable requirements of ANSI/AWWA C151/A21.51 with standard ductile iron outside diameters. Threads were taper pipe threads in accordance with ANSI B2.1 adapted to standard ductile iron pipe outside diameters, as shown above. This pipe could be furnished with linings and coatings as described in Section 11.



AMERICAN Molox Ball Joint Pipe Technical Data

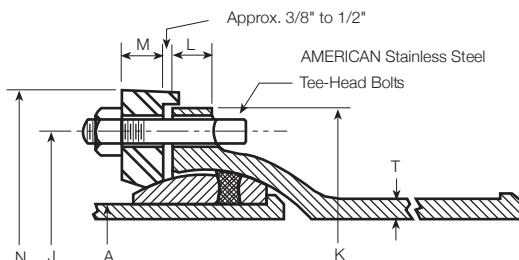

Table No. 12-16

| Size in. | Dimensions in inches | | | | | | Bolts | | | Approx. Joint Deflection |
|----------|----------------------|-------|-------|-------|------|------|---------------|----------|------------|--------------------------|
| | A | K | N | J | M | L | No. Per Joint | Size in. | Length in. | |
| 4 | 4.80 | 11.00 | 12.00 | 9.50 | 1.12 | 1.12 | 8 | 3/4 | 4 | 15° |
| 6 | 6.90 | 13.00 | 14.06 | 11.50 | 1.25 | 1.31 | 12 | 3/4 | 4 | 15° |
| 8 | 9.05 | 15.50 | 16.75 | 14.00 | 1.38 | 1.38 | 12 | 3/4 | 4 1/2 | 15° |
| 10 | 11.10 | 18.25 | 19.62 | 16.62 | 1.50 | 1.50 | 16 | 3/4 | 4 1/2 | 15° |
| 12 | 13.20 | 21.25 | 22.75 | 19.50 | 1.75 | 1.62 | 16 | 3/4 | 5 | 15° |
| 14 | 15.30 | 24.12 | 25.75 | 22.12 | 1.88 | 1.75 | 18 | 1 | 6 | 15° |
| 16 | 17.40 | 27.25 | 28.75 | 25.00 | 1.94 | 1.75 | 20 | 1 | 6 | 15° |
| 18 | 19.50 | 29.00 | 30.75 | 27.00 | 2.06 | 1.88 | 22 | 1 | 6 | 15° |
| 20 | 21.60 | 32.38 | 34.12 | 30.25 | 2.19 | 2.00 | 24 | 1 | 6 | 15° |
| 24 | 25.80 | 37.00 | 38.75 | 34.75 | 2.38 | 2.12 | 24 | 1 | 6 1/2 | 15° |
| 30 | 32.00 | 44.25 | 46.12 | 42.00 | 2.50 | 2.50 | 28 | 1 1/4 | 7 1/2 | 12 1/2° |
| 36 | 38.30 | 51.88 | 53.88 | 49.38 | 2.75 | 2.75 | 32 | 1 1/4 | 8 | 12 1/2° |
| 42 | 44.50 | 59.38 | 61.50 | 56.62 | 3.00 | 3.00 | 36 | 1 1/2 | 8 1/2 | 12 1/2° |
| 48 | 50.80 | 66.50 | 68.69 | 63.75 | 4.25 | 3.25 | 44 | 1 1/2 | 10 | 12 1/2° |
| 54 | 57.10 | 74.00 | 76.31 | 71.25 | 5.25 | 3.25 | 44 | 1 1/2 | 11 | 12 1/2° |

Contact AMERICAN for thickness "T" dimensions.

Laying Length/Overall Length

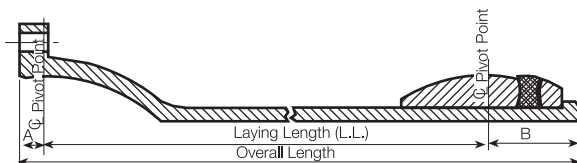

Table No. 12-17

| Size in. | A in. | B in. | Laying Length Socket and Ball | |
|----------|-------|-------|-------------------------------|--------------|
| | | | G.I. | D.I. |
| 4 | .81 | 2.31 | 18' - 0" | 20' - 2" |
| 6 | .94 | 2.44 | 18' - 0" | 20' - 2" |
| 8 | 1.06 | 2.69 | 18' - 0" | 20' - 2" |
| 10 | 1.12 | 3.50 | 17' - 10 1/2" | 20' - 2" |
| 12 | 1.25 | 4.25 | 15' - 10 1/2" | 20' - 2" |
| 14 | 1.37 | 4.88 | 15' - 9 1/2" | 15' - 10" |
| 16 | 1.50 | 5.25 | 15' - 9" | 15' - 9 1/2" |
| 18 | 1.62 | 5.50 | 15' - 9" | 15' - 9 1/2" |
| 20 | 1.75 | 6.38 | 15' - 8" | 15' - 8 1/2" |
| 24 | 2.12 | 6.38 | 15' - 8" | 15' - 8 1/2" |
| 30 | 2.50 | 7.00 | 15' - 6 1/2" | 15' - 7" |
| 36 | 2.69 | 7.81 | 15' - 6 1/2" | 15' - 7" |
| 42 | 2.94 | 8.56 | - | 19' - 6" |
| 48 | 3.19 | 9.19 | - | 19' - 6" |
| 54 | 3.59 | 9.75 | - | 19' - 6" |

To obtain overall lengths of Molox Ball Joint Pipe when used in combination with other conditions, the following formulas were applicable:

- Molox Socket & Molox Ball...A+B+L.L.*
- Molox Socket & Flange.....A+L.L.*
- Molox Socket & Plain End.....A+L.L.*
- Molox Ball & Flange.....B+L.L.*
- Molox Ball & Plain End.....B+L.L.*
- Molox Ball & Molox Ball.....2B+L.L.*

*Each "L.L." listed above refers to the laying length of the pipe with the particular combination of joints specified.

The manufacture of 4" through 36" Molox Pipe was discontinued in 1975 and 42"-54" was discontinued in 1991. Prior to 1975 some 4" through 12" Molox Pipe was furnished of ductile iron with thread-on bells; dimensions in Table No. 12-16 applied. See Section 10 for 4"-54" Flex-Lok Pipe.



AMERICAN Molox Ball Joint Bends

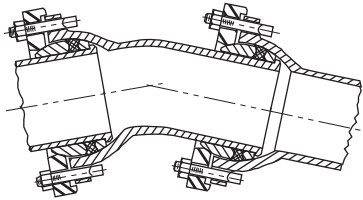

When deflection in excess of that allowed for one joint was required, the necessary deflection would often be made in two or more successive joints. If the installation conditions did not allow this, increased deflections would be obtained by the use of AMERICAN Molox Ball Joint Bends, as shown above. These bends were installed at any joint in the Molox Ball Joint pipeline. Bends were usually furnished with 22½° and 45° curvature, but other degrees of curvature were furnished when required.

In the event AMERICAN Molox Ball Joint Bends were not adaptable to the particular piping installation, the use of AMERICAN Ball Joint Double Hubs to provide additional deflection was recommended.

AMERICAN Molox Ball Joint Double Hubs

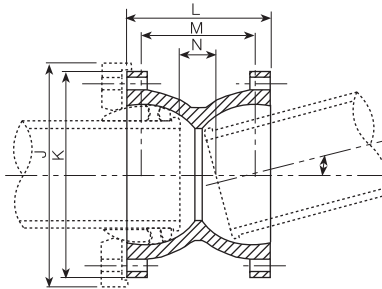

Table No. 12-18

| Size in. | Dimensions in inches | | | | | Weight lb | Maximum Deflection Provided |
|-------------|----------------------|-------|-------|-------|-------|--------------|-----------------------------------|
| | L | M | N | K | J | | |
| 4 | 8.00 | 6.50 | 2.00 | 11.00 | 12.00 | 60 | 30° |
| 6 | 9.00 | 7.12 | 2.25 | 13.00 | 14.06 | 90 | 30° |
| 8 | 11.00 | 8.88 | 3.50 | 15.50 | 16.75 | 140 | 30° |
| 10 | 13.00 | 10.75 | 3.75 | 18.25 | 19.62 | 200 | 30° |
| 12 | 15.50 | 13.00 | 4.50 | 21.25 | 22.75 | 300 | 30° |
| 14 | 17.50 | 14.75 | 5.00 | 24.12 | 25.75 | 390 | 30° |
| 16 | 18.50 | 15.50 | 5.00 | 27.25 | 28.75 | 520 | 30° |
| 18 | 20.75 | 17.51 | 6.50 | 29.00 | 30.75 | 650 | 30° |
| 20 | 22.75 | 19.25 | 6.50 | 32.38 | 34.12 | 880 | 30° |
| 24 | 24.50 | 20.25 | 7.50 | 37.00 | 38.75 | 1200 | 30° |
| 30 | 28.00 | 23.00 | 9.00 | 44.25 | 46.12 | 1840 | 25° |
| 36 | 31.50 | 26.12 | 10.50 | 51.88 | 53.88 | 2670 | 25° |

The angle of deflection provided by each end of the Molox Ball Joint Bend or Double Hub was the same as that indicated in Table No. 12-16 for the corresponding size of AMERICAN Molox Ball Joint Pipe.



AMERICAN Monoloy
Centrifugally Cast Gray Iron Pipe
 Manufactured to Steel Pipe Outside Diameters

AMERICAN Standard

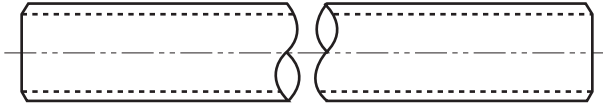

A-900
Plain End Pipe

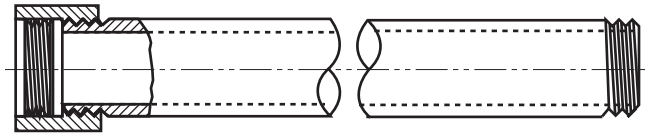

A-901
Threaded and Coupled Pipe

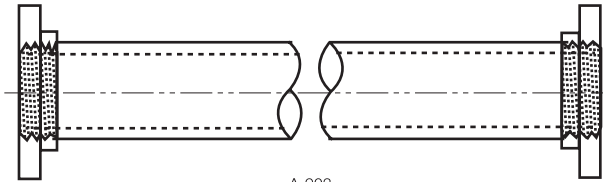

A-903
Flanged Pipe

Table No. 12-19

| Size in. | Pipe O.D. in. | Pipe I.D. in. | Wall Thickness in. | Standard Length ft.-in. | Weight in Pounds | | | A-902 Per Coupling |
|-------------|---------------------|---------------------|--------------------------|-------------------------------|-----------------------|----------------------------|---------------|--------------------------|
| | | | | | Per Foot Plain End | Per Length Plain End | Per Flange | |
| 2 | 2.38 | 1.88 | .25 | 11' - 6" | 5.2 | 60 | 4 | 3 |
| 3 | 3.50 | 2.78 | .36 | 16' - 0" | 11.1 | 180 | 7 | 5 |
| 4 | 4.50 | 3.76 | .37 | 16' - 0" | 15.0 | 240 | 12 | 7 |
| 5 | 5.56 | 4.80 | .38 | 16' - 0" | 19.3 | 310 | 14 | 10 |
| 6 | 6.62 | 5.82 | .40 | 16' - 0" | 24.4 | 390 | 17 | 13 |
| 8 | 8.62 | 7.70 | .46 | 16' - 0" | 36.8 | 590 | 25 | 20 |
| 10 | 10.75 | 9.71 | .52 | 16' - 0" | 52.1 | 835 | 35 | 35 |
| 12 | 12.75 | 11.59 | .58 | 16' - 0" | 69.2 | 1105 | 55 | 50 |

AMERICAN Monoloy Mechanical Joint Pipe (A-905) was also available.

AMERICAN Monoloy Pipe was discontinued in 1972.

Threaded Joint Ductile Iron Pipe, 4"-24", is still available with ductile iron pipe outside diameters. See Section 2.



**AMERICAN 2" and 2 1/4"
Centrifugally Cast Gray Iron Pipe
ANSI A21.12 Standard**

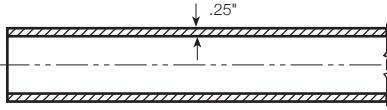

A-700
2"

Plain End Pipe

A-800
2 1/4"

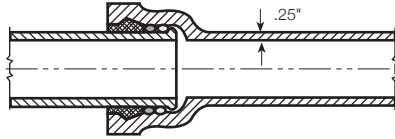

A-701
2"

Bell and Spigot Pipe

A-801
2 1/4"

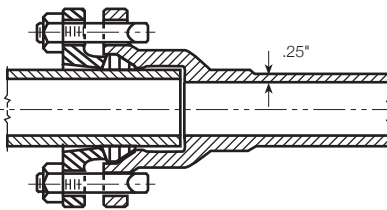

A-702
2"

Mechanical Joint Pipe

A-802
2 1/4"

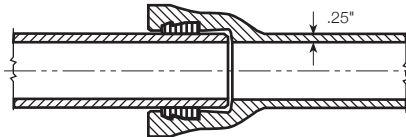

A-703
2"

Fastite Pipe

A-803
2 1/4"

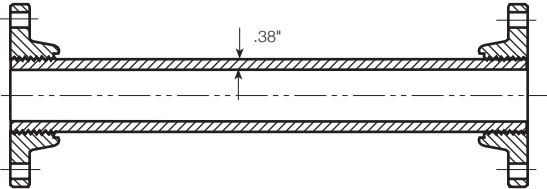

A-706
2"

Flange and Flange Pipe

Table No. 12-20

| Type Joint | 2" Pipe | | | | | 2 1/4" Pipe | | | | |
|------------|----------------------------|------------------|--------------------|---------------------|--------------------|----------------------------|------------------|--------------------|---------------------|--------------------|
| | Max. Laying Length ft.-in. | Weight in Pounds | | | | Max. Laying Length ft.-in. | Weight in Pounds | | | |
| | | Bell or Flange | Per Foot Plain End | Per Foot Incl. Bell | Max. Laying Length | | Bell or Flange | Per Foot Plain End | Per Foot Incl. Bell | Max. Laying Length |
| Plain End | 11' - 6" | - | 5.5 | - | 63 | 11' - 6" | - | 6.12 | - | 70 |
| Bell | 12' - 0" | 4 | 5.5 | 5.83 | 70 | 12' - 0" | 4.6 | 6.12 | 6.5 | 78 |
| Mechanical | 12' - 0" | 4 | 5.5 | 5.83 | 70 | 12' - 0" | 4.6 | 6.12 | 6.5 | 78 |
| Fastite | 12' - 0" | 4 | 5.5 | 5.83 | 70 | 12' - 0" | 4.6 | 6.12 | 6.5 | 78 |
| Flange | 11' - 6" | 4 | 8.8 | - | *109 | - | - | - | - | - |

*With two flanges.

The manufacture of 2" and 2 1/4" Pipe was discontinued in 1975.

On Flange and Flange Pipe flanges were threaded on one or both ends.



AWWA Bell and Spigot Fittings AWWA C100

Standard Dimensions

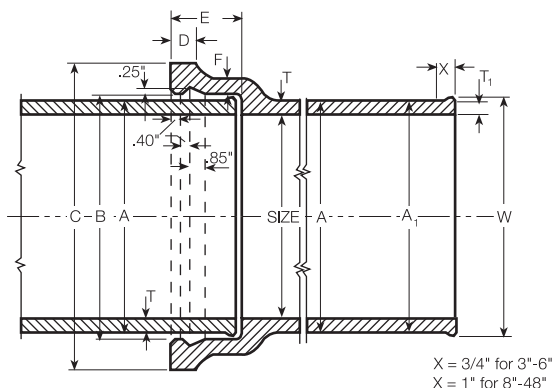

Table No. 12-21

| Size in. | Class | Dimensions in Inches | | | | | | | | | |
|----------|-------|----------------------|----------------|-------|-------|------|------|------|------|----------------|-------|
| | | A | A ₁ | B | C | D | E | F | T | T ₁ | W |
| 3 | D | 3.96 | 3.96 | 4.66 | 7.26 | 1.25 | 3.50 | .65 | .48 | .48 | 4.34 |
| 4 | D | 5.00 | 4.90 | 5.70 | 8.30 | 1.50 | 4.00 | .65 | .52 | .47 | 5.28 |
| 6 | D | 7.10 | 7.00 | 7.80 | 10.60 | 1.50 | 4.00 | .70 | .55 | .50 | 7.38 |
| 8 | D | 9.30 | 9.18 | 10.00 | 13.00 | 1.50 | 4.00 | .75 | .60 | .54 | 9.56 |
| 10 | D | 11.40 | 11.25 | 12.10 | 15.30 | 1.50 | 4.00 | .80 | .68 | .60 | 11.63 |
| 12 | D | 13.50 | 13.35 | 14.20 | 17.60 | 1.50 | 4.00 | .85 | .75 | .68 | 13.73 |
| 14 | B | 15.30 | 15.30 | 16.10 | 19.50 | 1.50 | 4.00 | .85 | .66 | .66 | 15.80 |
| 14 | D | 15.65 | 15.65 | 16.45 | 20.05 | 1.50 | 4.00 | .90 | .82 | .82 | 16.15 |
| 16 | B | 17.40 | 17.40 | 18.40 | 22.00 | 1.75 | 4.00 | .90 | .70 | .70 | 17.90 |
| 16 | D | 17.80 | 17.80 | 18.80 | 22.60 | 1.75 | 4.00 | 1.00 | .89 | .89 | 18.30 |
| 18 | B | 19.50 | 19.50 | 20.50 | 24.30 | 1.75 | 4.00 | .95 | .75 | .75 | 20.00 |
| 18 | D | 19.92 | 19.92 | 20.92 | 25.12 | 1.75 | 4.00 | 1.05 | .96 | .96 | 20.42 |
| 20 | B | 21.60 | 21.60 | 22.60 | 26.60 | 1.75 | 4.00 | 1.00 | .80 | .80 | 22.10 |
| 20 | D | 22.06 | 22.06 | 23.06 | 27.66 | 1.75 | 4.00 | 1.15 | 1.03 | 1.03 | 22.56 |
| 24 | B | 25.80 | 25.80 | 26.80 | 31.00 | 2.00 | 4.00 | 1.05 | .89 | .89 | 26.30 |
| 24 | D | 26.32 | 26.32 | 27.32 | 32.32 | 2.00 | 4.00 | 1.25 | 1.16 | 1.16 | 26.82 |
| 30 | A | 31.74 | 31.74 | 32.74 | 37.34 | 2.00 | 4.50 | 1.15 | .88 | .88 | 32.24 |
| 30 | B | 32.00 | 32.00 | 33.00 | 37.60 | 2.00 | 4.50 | 1.15 | 1.03 | 1.03 | 32.50 |
| 30 | C | 32.40 | 32.40 | 33.40 | 38.60 | 2.00 | 4.50 | 1.32 | 1.20 | 1.20 | 32.90 |
| 30 | D | 32.74 | 32.74 | 33.74 | 39.74 | 2.00 | 4.50 | 1.50 | 1.37 | 1.37 | 33.24 |
| 30 | *B/D | 32.74 | 32.00 | 33.00 | 39.00 | 2.00 | 4.50 | 1.50 | 1.37 | 1.03 | 32.50 |
| 36 | A | 37.96 | 37.96 | 38.96 | 43.96 | 2.00 | 4.50 | 1.25 | .99 | .99 | 38.46 |
| 36 | B | 38.30 | 38.30 | 39.30 | 44.90 | 2.00 | 4.50 | 1.40 | 1.15 | 1.15 | 38.80 |
| 36 | C | 38.70 | 38.70 | 39.70 | 45.90 | 2.00 | 4.50 | 1.60 | 1.36 | 1.36 | 39.20 |
| 36 | D | 39.16 | 39.16 | 40.16 | 46.96 | 2.00 | 4.50 | 1.80 | 1.58 | 1.58 | 39.66 |
| 36 | *B/D | 39.16 | 38.30 | 39.30 | 46.10 | 2.00 | 4.50 | 1.80 | 1.58 | 1.15 | 38.80 |
| 42 | A | 44.20 | 44.20 | 45.20 | 50.80 | 2.00 | 5.00 | 1.40 | 1.10 | 1.10 | 44.70 |
| 42 | B | 44.50 | 44.50 | 45.50 | 51.50 | 2.00 | 5.00 | 1.50 | 1.28 | 1.28 | 45.00 |
| 42 | C | 45.10 | 45.10 | 46.10 | 52.90 | 2.00 | 5.00 | 1.75 | 1.54 | 1.54 | 45.60 |
| 42 | D | 45.58 | 45.58 | 46.58 | 54.18 | 2.00 | 5.00 | 1.95 | 1.78 | 1.78 | 46.08 |
| 42 | *B/D | 45.58 | 44.50 | 45.50 | 53.10 | 2.00 | 5.00 | 1.95 | 1.78 | 1.28 | 45.00 |
| 48 | A | 50.50 | 50.50 | 51.50 | 57.50 | 2.00 | 5.00 | 1.50 | 1.26 | 1.26 | 51.00 |
| 48 | B | 50.80 | 50.80 | 51.80 | 58.40 | 2.00 | 5.00 | 1.65 | 1.42 | 1.42 | 51.30 |
| 48 | C | 51.40 | 51.40 | 52.40 | 60.00 | 2.00 | 5.00 | 1.95 | 1.71 | 1.71 | 51.90 |
| 48 | D | 51.98 | 51.98 | 52.98 | 61.38 | 2.00 | 5.00 | 2.20 | 1.96 | 1.96 | 52.48 |
| 48 | *B/D | 51.98 | 50.80 | 51.80 | 60.20 | 2.00 | 5.00 | 2.20 | 1.96 | 1.42 | 51.30 |

*B/D was an AMERICAN designation for fittings 30" and larger having Class B socket and spigot diameters with Class D metal thickness.



AWWA Bell & Spigot Fittings Standard Bell & Bell and Bell & Spigot Bends — Laying Dimensions AWWA C100

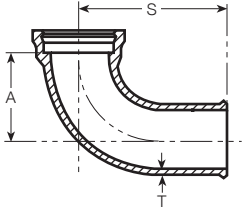

A-201
Bell & Spigot
90° Bend

A-200
Bell & Bell
90° Bend

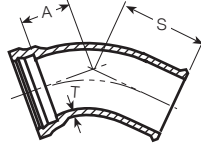

A-203
Bell & Spigot
45° Bend

A-202
Bell & Bell
45° Bend

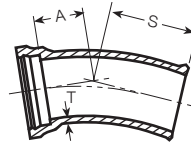

A-205
Bell & Spigot
22 1/2° Bend

A-204
Bell & Bell
22 1/2° Bend

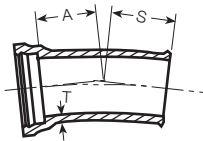

A-207
Bell & Spigot
11 1/4° Bend

A-206
Bell & Bell
11 1/4° Bend

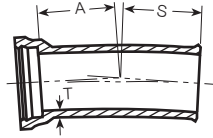

A-209
Bell & Spigot
5 5/8° Bend

A-208
Bell & Bell
5 5/8° Bend

Table No. 12-22

| Dimensions in Inches | | | | | | | | | | |
|----------------------|----------------|----|----------------|-------|-----------------|-------|-----------------|-------|----------------|-------|
| Size in. | 90° Bend (¼th) | | 45° Bend (½th) | | 22½° Bend (¾th) | | 11¼° Bend (¾nd) | | 5⅝° Bend (¾th) | |
| | A | S | A | S | A | S | A | S | A | S |
| 3 | 16 | 24 | 9.94 | 15.94 | 9.55 | 15.55 | 11.82 | 11.82 | - | - |
| 4 | 16 | 24 | 9.94 | 15.94 | 9.55 | 15.55 | 11.82 | 11.82 | - | - |
| 6 | 16 | 24 | 9.94 | 15.94 | 9.55 | 15.55 | 11.82 | 11.82 | - | - |
| 8 | 16 | 26 | 9.94 | 15.94 | 9.55 | 15.55 | 11.82 | 11.82 | - | - |
| 10 | 16 | 28 | 9.94 | 15.94 | 9.55 | 15.55 | 11.82 | 11.82 | - | - |
| 12 | 16 | 28 | 9.94 | 15.94 | 9.55 | 15.55 | 11.82 | 11.82 | - | - |
| 14 | 18 | 30 | 14.91 | 20.91 | 14.32 | 14.32 | 17.73 | 17.73 | - | - |
| 16 | 24 | 36 | 14.91 | 20.91 | 14.32 | 14.32 | 17.73 | 17.73 | - | - |
| 18 | 24 | 36 | 14.91 | 20.91 | 14.32 | 14.32 | 17.73 | 17.73 | - | - |
| 20 | 24 | 36 | 19.88 | 25.88 | 19.10 | 19.10 | 23.64 | 23.64 | 23.58 | 23.58 |
| 24 | 30 | 42 | 24.85 | 30.85 | 23.87 | 23.87 | 23.64 | 23.64 | 23.58 | 23.58 |
| 30 | 36 | 48 | 24.85 | 30.85 | 23.87 | 23.87 | 23.64 | 23.64 | 23.58 | 23.58 |
| 36 | 48 | 60 | 37.28 | 37.28 | 35.80 | 35.80 | 23.64 | 23.64 | 23.58 | 23.58 |
| 42 | 48 | 60 | 37.28 | 37.28 | 35.80 | 35.80 | 23.64 | 23.64 | 23.58 | 23.58 |
| 48 | 54 | 66 | 37.28 | 37.28 | 35.80 | 35.80 | 23.64 | 23.64 | 23.58 | 23.58 |
| 54 | - | - | 37.28 | 37.28 | 35.80 | 35.80 | 23.64 | 23.64 | 23.58 | 23.58 |
| 60 | - | - | 37.28 | 37.28 | 35.80 | 35.80 | 23.64 | 23.64 | 23.58 | 23.58 |

All fittings were furnished Bell and Bell as well as Bell and Spigot.
For "T" see Table No. 12-1.



AWWA Bell & Spigot Fittings Standard All Bell and Bell & Spigot Tees and Crosses — Laying Dimensions

AWWA C100

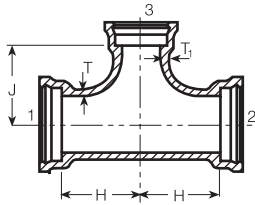

A-214
All Bell Tee

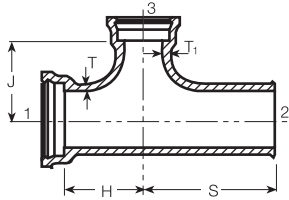

A-215
Bell - Spigot
& Bell Tee

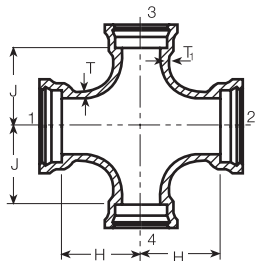

A-21
All Bell

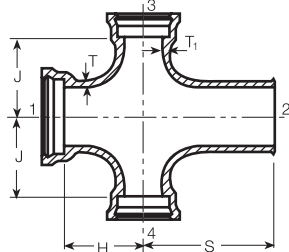

A-21
Bell - Spigot -
Bell & Bell

Table No. 12-23

| Dimensions in Inches | | | | | | | | | | | |
|----------------------|----|----|----|----------|----|----|----|----------|----|----|----|
| Size in. | H | J | S | Size in. | H | J | S | Size in. | H | J | S |
| 3 | 10 | 10 | 22 | 30 x 18 | 20 | 26 | 34 | 42 x 18 | 20 | 32 | 34 |
| 4 | 11 | 11 | 23 | 30 x 20 | 21 | 26 | 36 | 42 x 20 | 21 | 32 | 36 |
| 6 | 12 | 12 | 24 | 30 x 24 | 23 | 26 | 38 | 42 x 24 | 23 | 32 | 38 |
| 8 | 13 | 13 | 25 | 30 x 30 | 26 | 26 | 43 | 42 x 30 | 26 | 32 | 43 |
| 10 | 14 | 14 | 26 | 36 x 8 | 14 | 27 | 26 | 42 x 36 | 29 | 32 | 46 |
| 12 | 15 | 15 | 27 | 36 x 10 | 15 | 27 | 27 | 42 x 42 | 32 | 32 | 49 |
| 14 | 16 | 16 | 28 | 36 x 12 | 16 | 27 | 28 | 48 x 12 | 17 | 33 | 29 |
| 16 | 17 | 17 | 29 | 36 x 14 | 18 | 29 | 30 | 48 x 14 | 18 | 35 | 30 |
| 18 | 18 | 18 | 30 | 36 x 16 | 19 | 29 | 31 | 48 x 16 | 19 | 35 | 31 |
| 20 | 19 | 19 | 31 | 36 x 18 | 20 | 29 | 34 | 48 x 18 | 20 | 35 | 34 |
| 24 | 21 | 21 | 33 | 36 x 20 | 21 | 29 | 36 | 48 x 20 | 21 | 35 | 36 |
| 30 x 6 | 13 | 24 | 25 | 36 x 24 | 23 | 29 | 38 | 48 x 24 | 23 | 35 | 38 |
| 30 x 8 | 14 | 24 | 26 | 36 x 30 | 26 | 29 | 43 | 48 x 30 | 26 | 35 | 43 |
| 30 x 10 | 15 | 24 | 27 | 36 x 36 | 29 | 29 | 46 | 48 x 36 | 29 | 35 | 46 |
| 30 x 12 | 15 | 24 | 27 | 42 x 12 | 16 | 30 | 28 | 48 x 42 | 32 | 35 | 49 |
| 30 x 14 | 18 | 26 | 30 | 42 x 14 | 18 | 32 | 30 | 48 x 48 | 35 | 35 | 52 |
| 30 x 16 | 19 | 26 | 31 | 42 x 16 | 19 | 32 | 31 | - | - | - | - |

Reducing tees and crosses in sizes up to and including 24" had same laying dimensions as straight sizes. Large diameter tees and crosses were furnished with ribs as required. For "T" see Table No. 12-1.

AMERICAN HISTORICAL DATA — OBSOLETE PIPING MATERIALS



AWWA Bell & Spigot Fittings

Standard Reducers — Laying Dimensions

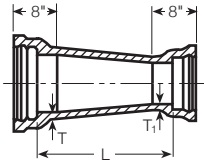

A-224
Bell & Bell
Reducer

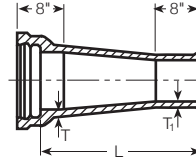

A-225
Large End
Bell Reducer

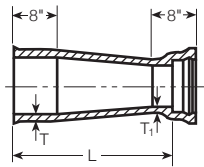

A-226
Small End
Bell Reducer

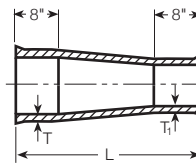

A-227
Spigot &
Spigot Reducer

Table No. 12-24

| Dimensions in Inches | | | | | | | | | |
|----------------------|-------------------|----------------|----------------|-------------|----------|-------------------|----------------|----------------|-------------|
| Size in. | Laying Length (L) | | | | Size in. | Laying Length (L) | | | |
| | Bell & Bell | Large End Bell | Small End Bell | Spigot Ends | | Bell & Bell | Large End Bell | Small End Bell | Spigot Ends |
| 3 | 18.0 | 20.5 | 21.5 | 24 | 36 x 24 | 39.5 | 43.5 | 44.0 | 48 |
| *4 | 16.5 | 20.0 | 20.5 | 24 | 36 x 24 | 73.5 | 77.5 | 78.0 | 82 |
| *6 | 26.0 | 30.0 | 30.0 | 34 | 36 x 30 | 39.0 | 43.5 | 43.5 | 48 |
| *8 | 26.0 | 30.0 | 30.0 | 34 | 36 x 30 | 73.0 | 77.5 | 77.5 | 82 |
| 10 | 26.0 | 30.0 | 30.0 | 34 | 42 x 20 | 39.0 | 43.0 | 44.0 | 48 |
| 12 | 26.0 | 30.0 | 30.0 | 34 | 42 x 20 | 73.0 | 77.0 | 78.0 | 82 |
| 14 | 28.0 | 32.0 | 32.0 | 36 | 42 x 24 | 39.0 | 43.0 | 44.0 | 48 |
| 16 | 28.0 | 32.0 | 32.0 | 36 | 42 x 24 | 73.0 | 77.0 | 78.0 | 82 |
| 18 | 28.0 | 32.0 | 32.0 | 36 | 42 x 30 | 38.5 | 43.0 | 43.5 | 48 |
| 20 | 34.0 | 38.0 | 38.0 | 42 | 42 x 30 | 72.5 | 77.0 | 77.5 | 82 |
| 24 | 34.0 | 38.0 | 38.0 | 42 | 42 x 36 | 38.5 | 43.0 | 43.5 | 48 |
| 30 x 18 | 33.5 | 37.5 | 38.0 | 42 | 42 x 36 | 72.5 | 77.0 | 77.5 | 82 |
| 30 x 20 | 33.5 | 37.5 | 38.0 | 42 | 48 x 30 | 72.5 | 77.0 | 77.5 | 82 |
| 30 x 20 | 73.5 | 77.5 | 78.0 | 82 | 48 x 30 | 138.5 | 143.0 | 143.5 | 148 |
| 30 x 24 | 33.5 | 37.5 | 38.0 | 42 | 48 x 36 | 72.5 | 77.0 | 77.5 | 82 |
| 30 x 24 | 73.5 | 77.5 | 78.0 | 82 | 48 x 36 | 138.5 | 143.0 | 143.5 | 148 |
| 36 x 20 | 39.5 | 43.5 | 44.0 | 48 | 48 x 42 | 72.0 | 77.0 | 77.0 | 82 |
| 36 x 20 | 73.5 | 77.5 | 78.0 | 82 | 48 x 42 | 138.0 | 143.0 | 143.0 | 148 |

*In sizes 3" through 24", laying length was the same for all reductions except as noted below:

- 4 x 2 Reducers Small End Bell had a laying length of 21 inches.
- 4 x 2 Reducers Bell & Bell had a laying length of 17.5 inches.
- 6 x 2 Reducers Bell & Bell had a laying length of 27.5 inches.
- 6 x 3 Reducers Small End Bell had a laying length of 30.5 inches.
- 6 x 3 Reducers Bell & Bell had a laying length of 26.5 inches.
- 8 x 3 Reducers Bell & Bell had a laying length of 26.5 inches.

For "T" see Table No. 12-1.



AMERICAN Specials Caulked Joint Sleeves and Split Sleeves

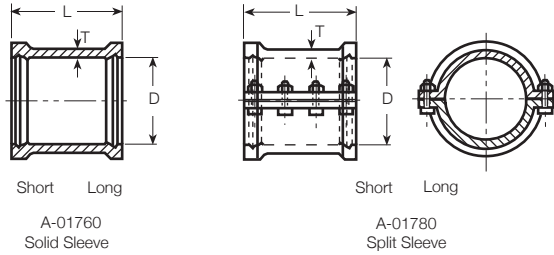

Table No. 12-25

| Size in. | AWWA C100 Class | Dimensions in Inches | | | | Weight in Pounds | | | |
|----------|-----------------|----------------------|------|----------|------|------------------|------|---------------|------|
| | | D | T | L Length | | Solid Sleeves | | Split Sleeves | |
| | | | | Short | Long | A-01760 | | A-01780 | |
| | | | | | | Short | Long | Short | Long |
| 4 | D | 5.80 | .65 | 10 | 15 | 45 | 65 | 65 | 100 |
| 6 | D | 7.90 | .70 | 10 | 15 | 65 | 90 | 90 | 130 |
| 8 | D | 10.10 | .75 | 12 | 15 | 100 | 120 | 135 | 165 |
| 10 | D | 12.20 | .80 | 12 | 18 | 130 | 180 | 165 | 245 |
| 12 | D | 14.30 | .85 | 14 | 18 | 185 | 225 | 230 | 295 |
| 14 | B | 16.20 | .85 | 15 | 18 | 215 | 255 | 275 | 310 |
| 14 | D | 16.50 | .90 | 15 | 18 | 235 | 275 | 300 | 355 |
| 16 | B | 18.50 | .90 | 15 | 24 | 270 | 400 | 330 | 510 |
| 16 | D | 18.90 | 1.00 | 15 | 24 | 300 | 445 | 370 | 575 |
| 18 | B | 20.60 | .95 | 15 | 24 | 320 | 470 | 380 | 585 |
| 18 | D | 21.00 | 1.05 | 15 | 24 | 360 | 530 | 430 | 685 |
| 20 | B | 22.70 | 1.00 | 15 | 24 | 370 | 540 | 435 | 665 |
| 20 | D | 23.10 | 1.15 | 15 | 24 | 435 | 640 | 505 | 800 |
| 24 | B | 26.90 | 1.05 | 15 | 24 | 470 | 685 | 535 | 820 |
| 24 | D | 27.40 | 1.25 | 15 | 24 | 575 | 840 | 670 | 1010 |
| 30 | B | 33.10 | 1.15 | 15 | 24 | 630 | 920 | - | 1060 |
| 30 | D | 33.80 | 1.50 | 15 | 24 | 860 | 1250 | - | 1415 |
| 36 | B | 39.40 | 1.40 | 15 | 24 | 920 | 1340 | - | 1500 |
| 36 | D | 40.20 | 1.80 | 15 | 24 | 1195 | 1750 | - | 1945 |
| 42 | B | 45.60 | 1.50 | 15 | 24 | 1140 | 1660 | - | 1855 |
| 42 | D | 46.70 | 1.95 | 15 | 24 | 1530 | 2230 | - | 2460 |
| 48 | B | 51.90 | 1.65 | 15 | 24 | 1435 | 2080 | - | 2290 |
| 48 | D | 53.10 | 2.20 | 15 | 24 | 1950 | 2845 | - | 3100 |
| 54 | B | 58.20 | 1.80 | 15 | 24 | 1800 | 2595 | - | - |

Weight of Split Sleeve includes weight of side flange bolts and gaskets.
Fittings were normally gray iron but were furnished of ductile iron when specified.

AMERICAN HISTORICAL DATA — OBSOLETE PIPING MATERIALS



Short Body Bell & Spigot Fittings ANSI A21.10 Standard AMERICAN Standard

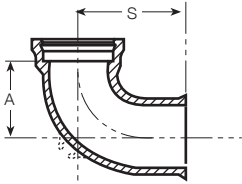

A-101
Bell & Spigot
90° Bend

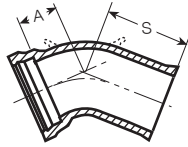

A-103
Bell & Spigot
45° Bend

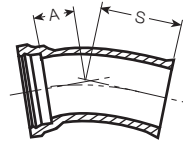

A-105
Bell & Spigot
22 1/2° Bend

A-100
Bell & Bell
90° Bend

A-102
Bell & Bell
45° Bend

A-104
Bell & Bell
22 1/2° Bend

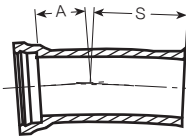

A-107
Bell & Spigot
11 1/4° Bend

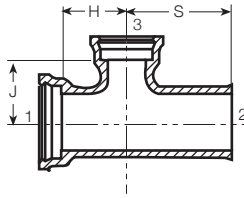

A-115
Bell - Spigot
& Bell Tee

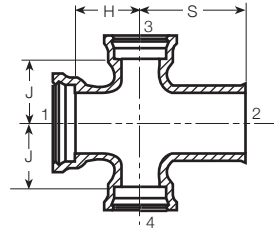

A-117
Bell - Spigot -
Bell & Bell Cross

A-106
Bell & Bell
11 1/4° Bend

A-114
All Bell Tee

A-116
All Bell Cross

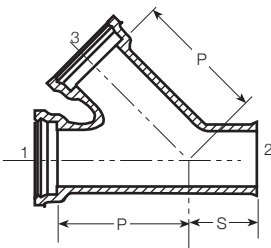

A-123
Bell, Spigot &
Bell Wye

A-122
All Bell Wye

A-124
Bell & Bell
Reducer

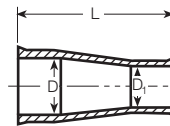

A-127
Spigot & Spigot
Reducer

A-125
Large End
Bell Reducer

A-126
Small End
Bell Reducer

Fig. 12-3

AMERICAN furnished a complete line of Short Body Bell and Spigot Fittings per ANSI A21.10 and AMERICAN Standard as shown above. Bell and Bell as well as Bell and Spigot Fittings (including Spigot and Spigot Reducers) were furnished. The laying length dimensions and "R" dimensions were the same as those of the corresponding mechanical joint and flange fittings per AWWA C110. See Sections 5 and 6.



AMERICAN Ductile Iron Flanged Fittings
AMERICAN Standard
Flanged Double Branch 90° Bends
and Return Bends

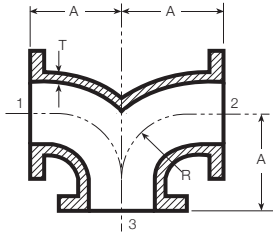

A-30380
 Double Branch 90° Bend

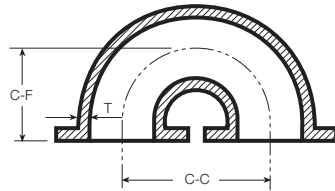

A-30740
 Return Bend

Table No. 12-26

| Size in. | Pressure Rating psi | T in. | A-30380 Double Branch 90° Bend | | | A-30740 Return Bend | | |
|----------|---------------------|-------|--------------------------------|------|-----------|----------------------|------|-----------|
| | | | Dimensions in inches | | Weight lb | Dimensions in inches | | Weight lb |
| | | | A | R | | C-C | C-F | |
| 4 | 250 | .52 | 6.5 | 4.5 | 60 | 9.5 | 6.5 | 55 |
| 6 | 250 | .55 | 8.0 | 6.0 | 95 | 12.0 | 8.0 | 95 |
| 8 | 250 | .60 | 9.0 | 7.0 | 155 | 20.0 | 9.0 | 170 |
| 10 | 250 | .68 | 11.0 | 9.0 | 240 | 20.0 | 10.0 | 245 |
| 12 | 250 | .75 | 12.0 | 10.0 | 345 | 24.0 | 12.0 | 380 |

Some larger size Return Bends are available.
 Numerals on cut indicate standard order of specifying size of fitting.
 See general notes on page 6-2.



AMERICAN Flanged Fittings

AWWA C100

90° and 45° Bends

Flanges F&D to Match ASA B16.1 Class 125

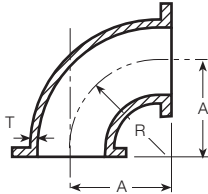

A-500
90° Bend

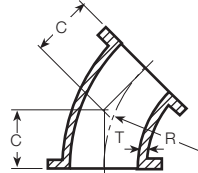

A-502
45° Bend

Table No. 12-27

| Size in. | Class | T in. | 90° Bend | | | 45° Bend | | |
|----------|-------|-------|----------|-------|-----------|----------|-------|-----------|
| | | | R in. | A in. | Weight lb | R in. | C in. | Weight lb |
| 3 | D | .48 | 16 | 16 | 45 | 24 | 9.94 | 35 |
| 4 | D | .52 | 16 | 16 | 70 | 24 | 9.94 | 60 |
| 6 | D | .55 | 16 | 16 | 100 | 24 | 9.94 | 80 |
| 8 | D | .60 | 16 | 16 | 145 | 24 | 9.94 | 125 |
| 10 | D | .68 | 16 | 16 | 205 | 24 | 9.94 | 170 |
| 12 | D | .75 | 16 | 16 | 285 | 24 | 9.94 | 240 |
| 14 | B | .66 | 18 | 18 | 330 | 36 | 14.91 | 330 |
| 14 | D | .82 | 18 | 18 | 380 | 36 | 14.91 | 385 |
| 16 | B | .70 | 24 | 24 | 495 | 36 | 14.91 | 405 |
| 16 | D | .89 | 24 | 24 | 590 | 36 | 14.91 | 475 |
| 18 | B | .75 | 24 | 24 | 575 | 36 | 14.91 | 465 |
| 18 | D | .96 | 24 | 24 | 690 | 36 | 14.91 | 550 |
| 20 | B | .80 | 24 | 24 | 690 | 48 | 19.88 | 690 |
| 20 | D | 1.03 | 24 | 24 | 830 | 48 | 19.88 | 830 |
| 24 | B | .89 | 30 | 30 | 1105 | 60 | 24.85 | 1105 |
| 24 | D | 1.16 | 30 | 30 | 1350 | 60 | 24.85 | 1350 |
| 30 | B | 1.03 | 36 | 36 | 1845 | 60 | 24.85 | 1600 |
| 30 | D | 1.37 | 36 | 36 | 2315 | 60 | 24.85 | 1985 |
| 36 | B | 1.15 | 48 | 48 | 3180 | 90 | 37.28 | 3015 |
| 36 | D | 1.58 | 48 | 48 | 4145 | 90 | 37.28 | 3915 |
| 42 | B | 1.28 | 48 | 48 | 4200 | 90 | 37.28 | 3985 |
| 42 | D | 1.78 | 48 | 48 | 5485 | 90 | 37.28 | 5185 |
| 48 | B | 1.42 | 54 | 54 | 5815 | 90 | 37.28 | 5005 |
| 48 | D | 1.96 | 54 | 54 | 7610 | 90 | 37.28 | 6475 |

The bends listed above and in Table No. 12-28, as well as the other flanged fittings referenced on page 12-32, were produced with wall thicknesses and laying lengths in accordance with the AWWA C100 Standard.



AMERICAN Flanged Fittings AWWA C100 22½°, 11¼° and 5% Bends

Flanges F&D to Match ASA B16.1 Class 125

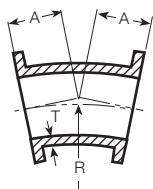

A-504
22½° Bend

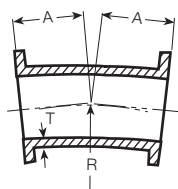

A-506
11¼° Bend

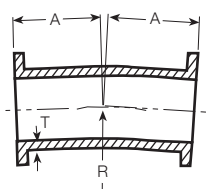

A-508
5% Bend

Table No. 12-28

| Size in. | Class | T in. | 22½° Bend | | | 11¼° Bend | | | 5% Bend | | |
|----------|-------|-------|-----------|-------|-----------|-----------|-------|-----------|---------|-------|-----------|
| | | | R in. | A in. | Weight lb | R in. | A in. | Weight lb | R in. | A in. | Weight lb |
| 3 | D | .48 | 48 | 9.55 | 35 | 120 | 11.82 | 45 | - | - | - |
| 4 | D | .52 | 48 | 9.55 | 60 | 120 | 11.82 | 65 | - | - | - |
| 6 | D | .55 | 48 | 9.55 | 80 | 120 | 11.82 | 95 | - | - | - |
| 8 | D | .60 | 48 | 9.55 | 125 | 120 | 11.82 | 145 | - | - | - |
| 10 | D | .68 | 48 | 9.55 | 170 | 120 | 11.82 | 195 | - | - | - |
| 12 | D | .75 | 48 | 9.55 | 240 | 120 | 11.82 | 270 | - | - | - |
| 14 | B | .66 | 72 | 14.32 | 330 | 180 | 17.73 | 385 | - | - | - |
| 14 | D | .82 | 72 | 14.32 | 385 | 180 | 17.73 | 455 | - | - | - |
| 16 | B | .70 | 72 | 14.32 | 405 | 180 | 17.73 | 470 | - | - | - |
| 16 | D | .89 | 72 | 14.32 | 475 | 180 | 17.73 | 565 | - | - | - |
| 18 | B | .75 | 72 | 14.32 | 465 | 180 | 17.73 | 545 | - | - | - |
| 18 | D | .96 | 72 | 14.32 | 550 | 180 | 17.73 | 655 | - | - | - |
| 20 | B | .80 | 96 | 19.10 | 690 | 240 | 23.64 | 820 | 480 | 23.58 | 820 |
| 20 | D | 1.03 | 96 | 19.10 | 830 | 240 | 23.64 | 1000 | 480 | 23.58 | 1000 |
| 24 | B | .89 | 120 | 23.87 | 1105 | 240 | 23.64 | 1105 | 480 | 23.58 | 1105 |
| 24 | D | 1.16 | 120 | 23.87 | 1350 | 240 | 23.64 | 1345 | 480 | 23.58 | 1345 |
| 30 | B | 1.03 | 120 | 23.87 | 1600 | 240 | 23.64 | 1600 | 480 | 23.58 | 1600 |
| 30 | D | 1.37 | 120 | 23.87 | 1985 | 240 | 23.64 | 1985 | 480 | 23.58 | 1985 |
| 36 | B | 1.15 | 180 | 35.80 | 3015 | 240 | 23.64 | 2195 | 480 | 23.58 | 2195 |
| 36 | D | 1.58 | 180 | 35.80 | 3915 | 240 | 23.64 | 2770 | 480 | 23.58 | 2770 |
| 42 | B | 1.28 | 180 | 35.80 | 3985 | 240 | 23.64 | 2920 | 480 | 23.58 | 2920 |
| 42 | D | 1.78 | 180 | 35.80 | 5185 | 240 | 23.64 | 3685 | 480 | 23.58 | 3685 |
| 48 | B | 1.42 | 180 | 35.80 | 5005 | 240 | 23.64 | 3655 | 480 | 23.58 | 3655 |
| 48 | D | 1.96 | 180 | 35.80 | 6475 | 240 | 23.64 | 4590 | 480 | 23.58 | 4590 |

In addition to bends shown in this Table and in Table No. 12-27, AMERICAN also produced AWWA C100 Flanged Tees, Crosses and Reducers which had the same laying length dimensions as the AWWA All Bell Fittings listed in Table Nos. 12-23 and 12-24.



**Mechanical Joint/Flanged and Long PE 90° Bends
AMERICAN Standard**

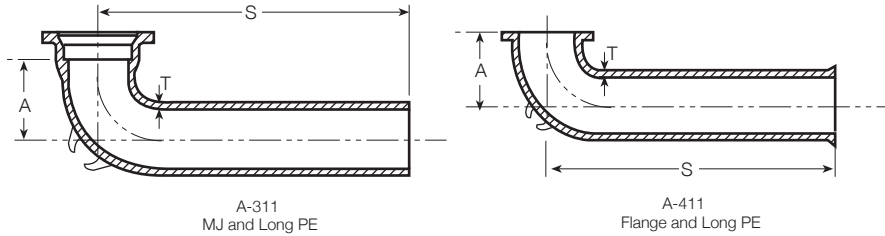

Table No. 12-29

| Size in. | Pressure Rating psi | Iron Strength psi (1000's) | Dimensions in Inches | | | Weight in Pounds | |
|----------|---------------------|----------------------------|----------------------|------|------|------------------|----------------|
| | | | T | A | S | A-311 MJ & PE | A-411 Flg & PE |
| 4 | 250 | 30 | 52 | 6.5 | 42.0 | 120 | 115 |
| 6 | 250 | 30 | 55 | 8.0 | 42.0 | 160 | 150 |
| 8 | 250 | 30 | 60 | 9.0 | 42.0 | 240 | 230 |
| 10 | 250 | 30 | 68 | 11.0 | 42.0 | 325 | 315 |
| 12 | 250 | 30 | 75 | 12.0 | 42.0 | 440 | 430 |

These bends were furnished with lugs as indicated when specified.



AMERICAN Ductile Iron Flanged Fittings

ANSI B16.1

Class 25 and Class 250 F&D Flanges

ANSI B16.1 covers both threaded flanges and flanged fittings for general service at ambient and elevated temperatures. The pressure ratings set forth are not primarily for water or other liquid service as are those in AWWA C110. ANSI B16.1 flanges and fittings are referenced here only for dimensional information.

Fittings: Class 25

AMERICAN manufactures flanged fittings to the strength requirements of AWWA C110 and with standard C110 flanges except with drilling to match the ANSI B16.1 Class 25 flanges when specified.

Flanges, Bolts and Gaskets Standard Dimensions Class 25

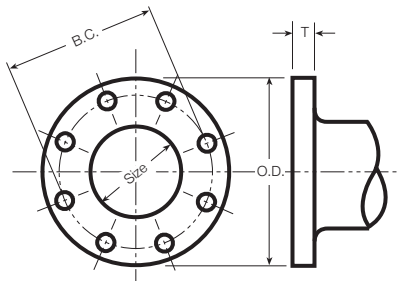

Table No. 12-30

| Size in. | Dimensions in inches | | | | | | |
|----------|----------------------|--------------|--------------------------|---------------|-------------|--------------------|---------------------|
| | O.D. Dia. of Flange | T Thickness* | B.C. Dia. of Bolt Circle | Bolts | | Bolt Hole Diameter | Size of Ring Gasket |
| | | | | No. Per Joint | Size | | |
| 4 | 9.00 | .75 | 7.50 | 8 | 3/8 x 2 1/2 | 3/8 | 4 x 6 1/2 |
| 6 | 11.00 | .75 | 9.50 | 8 | 3/8 x 2 1/2 | 3/8 | 6 x 8 1/2 |
| 8 | 13.50 | .75 | 11.75 | 8 | 3/8 x 2 1/2 | 3/8 | 8 x 11 1/2 |
| 10 | 16.00 | .88 | 14.25 | 12 | 3/8 x 2 3/4 | 3/8 | 10 x 13 1/2 |
| 12 | 19.00 | 1.00 | 17.00 | 12 | 3/8 x 3 | 3/8 | 12 x 16 1/2 |
| 14 | 21.00 | 1.12 | 18.75 | 12 | 3/4 x 3 1/2 | 7/8 | 14 x 18 |
| 16 | 23.50 | 1.12 | 21.25 | 16 | 3/4 x 3 1/2 | 7/8 | 16 x 20 1/2 |
| 18 | 25.00 | 1.25 | 22.75 | 16 | 3/4 x 3 3/4 | 7/8 | 18 x 22 |
| 20 | 27.50 | 1.25 | 25.00 | 20 | 3/4 x 3 3/4 | 7/8 | 20 x 24 1/2 |
| 24 | 32.00 | 1.38 | 29.50 | 20 | 3/4 x 4 | 7/8 | 24 x 28 1/2 |
| 30 | 38.75 | 1.50 | 36.00 | 28 | 7/8 x 4 1/2 | 1 | 30 x 35 1/2 |
| 36 | 46.00 | 1.62 | 42.75 | 32 | 7/8 x 4 3/4 | 1 | 36 x 41 1/2 |
| 42 | 53.00 | 1.75 | 49.50 | 36 | 1 x 5 1/4 | 1 1/8 | 42 x 48 1/2 |
| 48 | 59.50 | 2.00 | 56.00 | 44 | 1 x 5 3/4 | 1 1/8 | 48 x 55 |

*Thickness furnished is the same as AWWA C110 flange.



AMERICAN Ductile Iron Flanged Fittings

ANSI B16.1

Class 25 and Class 250 F&D Flanges—Continued

Fittings: Class 250

AMERICAN manufactures a limited number of special fittings in accordance with AWWA C110 except with laying dimensions per ANSI B16.1 Class 250 and with flanges faced and drilled to match the Class 250 flanges. AMERICAN does not manufacture any fittings to the requirements of ANSI B16.1 as listed in the following tables except for laying dimensions and facing and drilling as specifically noted.

Flanges, Bolts and Gaskets Standard Dimensions Class 250

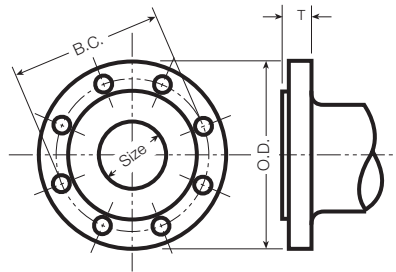

Table No. 12-31

| Size in. | Dimensions in Inches | | | | | | | |
|----------|----------------------|-------------|--------------------------|---------------------|---------------|---------------|--------------------|---------------------|
| | O.D. Dia. of Flange | T Thickness | B.C. Dia. of Bolt Circle | Dia. of Raised Face | Bolts | | Bolt Hole Diameter | Size of Ring Gasket |
| | | | | | No. Per Joint | Size | | |
| 2 | 6.50 | .88 | 5.00 | 4.19 | 8 | 3/8 x 2 3/4 | 3/8 | 2 x 4 3/8 |
| 3 | 8.25 | 1.12 | 6.62 | 5.69 | 8 | 3/8 x 3 1/2 | 7/8 | 3 x 5 1/2 |
| 4 | 10.00 | 1.25 | 7.88 | 6.94 | 8 | 3/8 x 3 3/4 | 7/8 | 4 x 7 1/2 |
| 5 | 11.00 | 1.38 | 9.25 | 8.31 | 8 | 3/8 x 4 | 7/8 | 5 x 8 1/2 |
| 6 | 12.50 | 1.44 | 10.62 | 9.69 | 12 | 3/8 x 4 | 7/8 | 6 x 9 1/2 |
| 8 | 15.00 | 1.62 | 13.00 | 11.94 | 12 | 7/8 x 4 1/2 | 1 | 8 x 12 1/2 |
| 10 | 17.50 | 1.88 | 15.25 | 14.06 | 16 | 1 x 5 1/4 | 1 1/8 | 10 x 14 1/4 |
| 12 | 20.50 | 2.00 | 17.75 | 16.44 | 16 | 1 1/8 x 5 1/2 | 1 1/8 | 12 x 16 1/2 |
| 14 | 23.00 | 2.12 | 20.25 | 18.94 | 20 | 1 1/8 x 6 | 1 1/8 | 14 x 19 1/2 |
| 16 | 25.50 | 2.25 | 22.50 | 21.06 | 20 | 1 1/8 x 6 1/4 | 1 3/8 | 16 x 21 1/4 |
| 18 | 28.00 | 2.38 | 24.75 | 23.31 | 24 | 1 1/4 x 6 1/2 | 1 3/8 | 18 x 23 1/2 |
| 20 | 30.50 | 2.50 | 27.00 | 25.56 | 24 | 1 1/4 x 6 3/4 | 1 3/8 | 20 x 25 1/2 |
| 24 | 36.00 | 2.75 | 32.00 | 30.31 | 24 | 1 1/2 x 7 1/2 | 1 3/8 | 24 x 30 1/2 |
| 30 | 43.00 | 3.00 | 39.25 | 37.19 | 28 | 1 3/8 x 8 1/2 | 2 | 30 x 37 1/2 |
| 36 | 50.00 | 3.38 | 46.00 | 43.69 | 32 | 2 x 9 1/2 | 2 1/4 | 36 x 44 |
| 42 | 57.00 | 3.69 | 52.75 | 50.44 | 36 | 2 x 10 | 2 1/4 | 42 x 50 1/2 |
| 48 | 65.00 | 4.00 | 60.75 | 58.44 | 40 | 2 x 10 3/4 | 2 1/4 | 48 x 58 1/2 |

ANSI B16.1 Class 250 Flanges have 0.06" raised face; this raised face is included in center-to-face and face-to-face dimensions. These B16.1 Class 250 Flanges can be furnished "special" without raised face; when so required, flanges should be specified "faced and drilled ANSI B16.1 Class 250, except flat faced."

On special order, AMERICAN furnishes pipe and fittings in some—but not all—sizes with flanges faced and drilled ANSI B16.1 Class 250.

Drilling of flanges can be rotated when required; for those sizes with an even number of bolt holes in each quadrant, fitting can be rotated 45° with standard drilling.



AMERICAN Ductile Iron Flanged Fittings ANSI B16.1 Dimensions of Class 250 Flanged Fittings

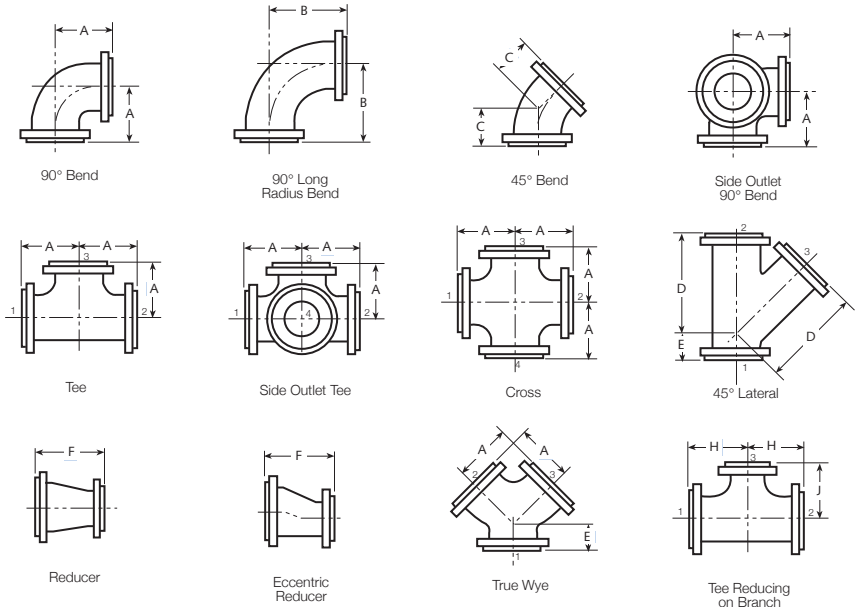

Table No. 12-32

| Nominal Pipe Size in. | Straight Size Fittings | | | | | | Reducing (Short Body) | | |
|-----------------------|---|--|----------------------------------|---------------------------------|--|-------------------------------|---|-----------------------------|---|
| | A Center to Face 90° Bend, Tees, Crosses, & True "Y" in. | B Center to Face 90° Long Radius Bend in. | C Center to Face 45° Bend in. | D Center to Face Lateral in. | E Short Center to Face True "Y" and Lateral in. | F Face to Face Reducer in. | Tees, Crosses | | |
| | | | | | | | Size of Branch and Smaller in. | H Center to Face Run in. | J Center to Face Outlet or Side Outlet in. |
| 3 | 6.00 | 7.75 | 3.50 | 11.00 | 3.00 | 6.0 | All reducing tees and crosses sizes 16 in. and smaller shall have same center-to-face dimensions as straight size fittings, corresponding to the size of the largest opening. | | |
| 3½ | 6.50 | 8.50 | 4.00 | 12.50 | 3.00 | 6.5 | | | |
| 4 | 7.00 | 9.00 | 4.50 | 13.50 | 3.00 | 7.0 | | | |
| 5 | 8.00 | 10.25 | 5.00 | 15.00 | 3.50 | 8.0 | | | |
| 6 | 8.50 | 11.50 | 5.50 | 17.50 | 4.00 | 9.0 | | | |
| 8 | 10.00 | 14.00 | 6.00 | 20.50 | 5.00 | 11.0 | | | |
| 10 | 11.50 | 16.50 | 7.00 | 24.00 | 5.50 | 12.0 | | | |
| 12 | 13.00 | 19.00 | 8.00 | 27.50 | 6.00 | 14.0 | 12 | 14.0 | 17.0 |
| 14 | 15.00 | 21.50 | 8.50 | 31.00 | 6.50 | 16.0 | 14 | 15.5 | 18.5 |
| 16 | 16.50 | 24.00 | 9.50 | 34.50 | 7.50 | 18.0 | 16 | 17.0 | 21.5 |
| 18 | 18.00 | 26.50 | 10.00 | 37.50 | 8.00 | 19.0 | 16 | 20.5 | 25.5 |
| 20 | 19.50 | 29.00 | 10.50 | 40.50 | 8.50 | 20.0 | 20 | 23.5 | 29.5 |
| 24 | 22.50 | 34.00 | 12.00 | 47.50 | 10.00 | 24.0 | 24 | 26.5 | 33.5 |
| 30 | 27.50 | 41.50 | 15.00 | - | - | 30.0 | 24 | 29.0 | 37.5 |
| 36 | 32.50 | 49.00 | 18.00 | - | - | 36.0 | 30 | - | - |
| 42 | 37.00 | 56.50 | 21.00 | - | - | 42.0 | - | - | - |
| 48 | 42.00 | 64.00 | 24.00 | - | - | 48.0 | - | - | - |

AMERICAN HISTORICAL DATA — OBSOLETE PIPING MATERIALS



AMERICAN Ductile Iron Flanged Fittings
ANSI B16.1

Dimensions of Class 250 Flanged Fittings — Continued

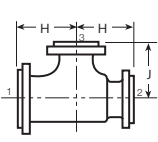

Tee Reducing on One Run and Branch

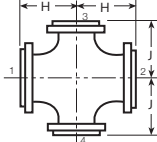

Cross Reducing on Both Branches

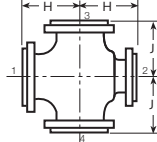

Cross Reducing on Run

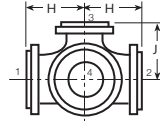

Side Outlet Tee or Cross Reducing on Branches

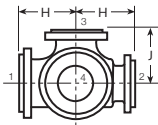

Side Outlet Tee or Cross Reducing on Run and Branches

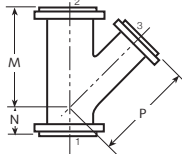

45° Lateral Reducing on Branch

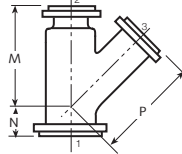

45° Lateral Reducing on Run and Branch

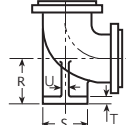

Base Bend

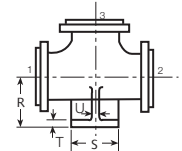

Base Tee

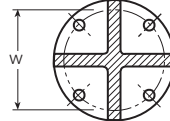

Round Base

Table 12-32 – Continued

| Nominal Pipe Size in. | Reducing (Short Body) | | | | Base Bends and Base Tees | | | | | | |
|-----------------------|--|--------------------------|--------------------------|-----------------------------|--------------------------|--------------------------|-------------------------|-------------------------|--------------------------------------|-------------------|-------------------|
| | Laterals | | | | R Center to Base in. | S Dia. of Round Base in. | T Thickness of Base in. | U Thickness of Ribs in. | Size of Supporting Pipe for Base in. | Base Drilling | |
| | Size of Branch and Smaller in. | M Center to Face Run in. | N Center to Face Run in. | P Center to Face Branch in. | | | | | | W Bolt Circle in. | Dia. of Holes in. |
| 3 | All reducing lateral sizes 16 in. and smaller shall have same center-to-face dimensions as straight size fittings, corresponding to the size of the largest opening. | | | | 5.25 | 6.12 | .81 | .62 | 1½ | 4.50 | .88 |
| 3½ | | | | | 5.62 | 6.12 | .81 | .62 | 1½ | 4.50 | .88 |
| 4 | | | | | 6.00 | 6.50 | .88 | .62 | 2 | 5.00 | .75 |
| 5 | | | | | 6.75 | 7.50 | 1.00 | .75 | 2½ | 5.88 | .88 |
| 6 | | | | | 7.50 | 7.50 | 1.00 | .75 | 2½ | 5.88 | .88 |
| 8 | | | | | 9.00 | 10.00 | 1.25 | .88 | 4 | 7.88 | .88 |
| 10 | | | | | 10.50 | 10.00 | 1.25 | .88 | 4 | 7.88 | .88 |
| 12 | | | | | 12.00 | 12.50 | 1.44 | 1.00 | 6 | 10.62 | .88 |
| 14 | | | | | 13.50 | 12.50 | 1.44 | 1.00 | 6 | 10.62 | .88 |
| 16 | | | | | 14.75 | 12.50 | 1.44 | 1.12 | 6 | 10.62 | .88 |
| 18 | 8 | 31 | 3 | 32.5 | 16.25 | 15.00 | 1.62 | 1.12 | 8 | 13.00 | 1.00 |
| 20 | 10 | 34 | 3 | 36.0 | 17.88 | 15.00 | 1.62 | 1.25 | 8 | 13.00 | 1.00 |
| 24 | 12 | 41 | 3 | 43.0 | 20.75 | 17.50 | 1.88 | 1.25 | 10 | 15.25 | 1.12 |
| 30 | - | - | - | - | - | - | - | - | - | - | - |
| 36 | - | - | - | - | - | - | - | - | - | - | - |
| 42 | - | - | - | - | - | - | - | - | - | - | - |
| 48 | - | - | - | - | - | - | - | - | - | - | - |



AMERICAN Ductile Iron Flanged Fittings ANSI B16.1 Threaded Companion Flanges and Blind Flanges Class 250

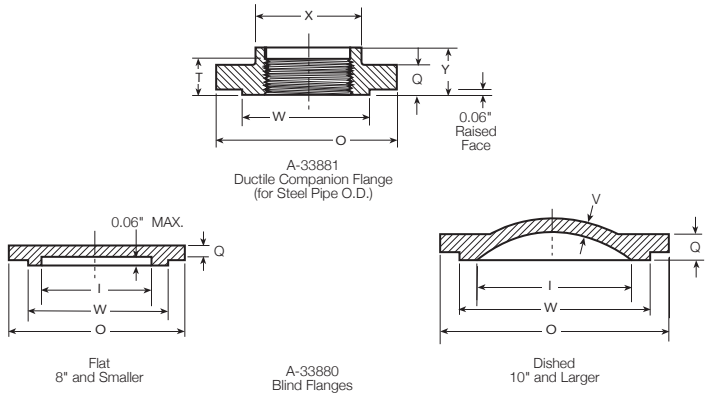

Table No. 12-33

| Nominal Pipe Size in. | O Dia. of Flange in. | Q Thickness of Flange (Min) in. | W Dia. of Raised in. | A-33880 Blind Flanges | | A-33881 Companion Flanges | | |
|-----------------------|----------------------|---------------------------------|----------------------|-----------------------|----------------------|---------------------------|--------------------------|-------------------------|
| | | | | I Dia. of Port in. | V Wall Thickness in. | X Dia. Hub (Min) in. | Y Length Through Hub in. | T Length of Threads in. |
| 1 | 4.88 | .69 | 2.69 | 1.00 | - | 2.06 | .88 | .68 |
| 1¼ | 5.25 | .75 | 3.06 | 1.25 | - | 2.50 | 1.00 | .81 |
| 1½ | 6.12 | .81 | 3.56 | 1.50 | - | 2.75 | 1.12 | .87 |
| 2 | 6.50 | .88 | 4.19 | 2.00 | - | 3.31 | 1.25 | 1.00 |
| 2½ | 7.50 | 1.00 | 4.94 | 2.50 | - | 3.94 | 1.43 | 1.13 |
| 3 | 8.25 | 1.12 | 5.69 | 3.00 | - | 4.62 | 1.56 | 1.19 |
| 3½ | 9.00 | 1.19 | 6.31 | 3.50 | - | 5.25 | 1.62 | 1.25 |
| 4 | 10.00 | 1.25 | 6.94 | 4.00 | - | 5.75 | 1.75 | 1.31 |
| 5 | 11.00 | 1.38 | 8.31 | 5.00 | - | 7.00 | 1.88 | 1.44 |
| 6 | 12.50 | 1.44 | 9.69 | 6.00 | - | 8.12 | 1.94 | 1.56 |
| 8 | 15.00 | 1.62 | 11.94 | 8.00 | - | 10.25 | 2.19 | 1.75 |
| 10 | 17.50 | 1.88 | 14.06 | 10.00 | .94 | 12.62 | 2.38 | 1.94 |
| 12 | 20.50 | 2.00 | 16.44 | 12.00 | 1.00 | 14.75 | 2.56 | 2.19 |
| 14 | 23.00 | 2.12 | 18.94 | 13.25 | 1.12 | 16.25 | 2.69 | 2.25 |
| 16 | 25.50 | 2.25 | 21.06 | 15.25 | 1.25 | 18.38 | 2.88 | 2.50 |
| 18 | 28.00 | 2.38 | 23.31 | 17.00 | 1.38 | - | - | - |
| 20 | 30.50 | 2.50 | 25.56 | 19.00 | 1.50 | - | - | - |
| 24 | 36.00 | 2.75 | 30.31 | 23.00 | 1.62 | - | - | - |
| 30 | 43.00 | 3.00 | 37.19 | 29.00 | 2.00 | - | - | - |
| *36 | 50.00 | 3.38 | 43.69 | - | - | - | - | - |
| *42 | 57.00 | 3.69 | 50.44 | - | - | - | - | - |
| *48 | 65.00 | 4.00 | 58.44 | - | - | - | - | - |

*Fittings in these sizes are not produced and used in sufficient quantities to warrant standardization; however, the flange dimensions are included for convenience where special fittings larger than 30 in. are required.
 All Blind Flanges for sizes 10 in. and larger must be dished with inside radius equal to the port diameter.
 Companion Flanges are furnished of ductile iron only and are threaded for fabrication on pipe of standard steel pipe outside diameter unless specified otherwise.
 See Section 8 for Companion Flange F&D ANSI B16.1 Class 250 for threading on ductile iron pipe.

AMERICAN HISTORICAL DATA — OBSOLETE PIPING MATERIALS



AMERICAN Mechanical Joint Fittings
ANSI/AWWA C110/A21.10

Offsets

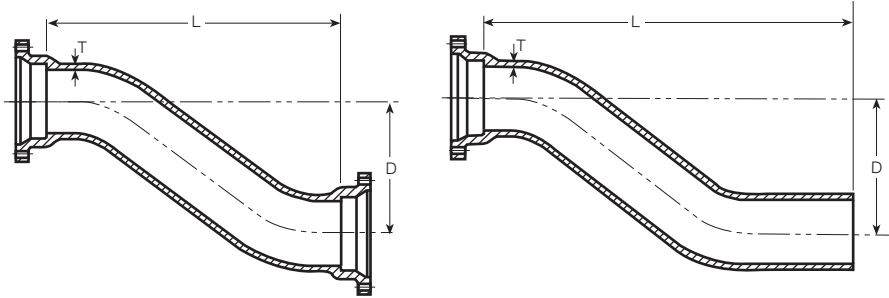

Table No. 12-34 A-10700
MJ and MJ

A-10701
MJ and PE

| Size in. | Pressure Rating psi | Iron Strength psi (1000's) | D in. | T in. | A-10700 MJ & MJ | | A-10701 MJ & PE | |
|----------|---------------------|----------------------------|-------|-------|-----------------|-----------|-----------------|-----------|
| | | | | | L in. | Weight lb | L in. | Weight lb |
| 4 | 250 | 25 | 6 | .52 | 19 | 75 | 27 | 70 |
| 4 | 350 | DI | 6 | .52 | 19 | 75 | 27 | 70 |
| 4 | 250 | 25 | 12 | .52 | 22 | 85 | 30 | 80 |
| 4 | 350 | DI | 12 | .52 | 22 | 85 | 30 | 80 |
| 4 | 250 | 25 | 18 | .52 | 30 | 105 | 38 | 100 |
| 4 | 350 | DI | 18 | .52 | 30 | 105 | 38 | 100 |
| *4 | 250 | 25 | 24 | .52 | 30 | 125 | 38 | 120 |
| *4 | 350 | DI | 24 | .52 | 30 | 125 | 38 | 120 |
| 6 | 250 | 25 | 6 | .55 | 20 | 110 | 28 | 105 |
| 6 | 350 | DI | 6 | .55 | 20 | 110 | 28 | 105 |
| 6 | 250 | 25 | 12 | .55 | 26 | 135 | 34 | 130 |
| 6 | 350 | DI | 12 | .55 | 26 | 135 | 34 | 130 |
| 6 | 250 | 25 | 18 | .55 | 33 | 165 | 41 | 160 |
| 6 | 350 | DI | 18 | .55 | 33 | 165 | 41 | 160 |
| *6 | 250 | 25 | 24 | .55 | 33 | 195 | 41 | 190 |
| *6 | 350 | DI | 24 | .55 | 33 | 195 | 41 | 190 |
| 8 | 250 | 25 | 6 | .60 | 21 | 160 | 29 | 155 |
| 8 | 350 | DI | 6 | .60 | 21 | 160 | 29 | 155 |
| 8 | 250 | 25 | 12 | .60 | 28 | 200 | 36 | 195 |
| 8 | 350 | DI | 12 | .60 | 28 | 200 | 36 | 195 |
| 8 | 250 | 25 | 18 | .60 | 35 | 245 | 43 | 240 |
| 8 | 350 | DI | 18 | .60 | 35 | 245 | 43 | 240 |
| 10 | 250 | 25 | 6 | .68 | 22 | 220 | 30 | 220 |
| 10 | 350 | DI | 6 | .68 | 22 | 220 | 30 | 220 |
| 10 | 250 | 25 | 12 | .68 | 30 | 280 | 38 | 280 |
| 10 | 350 | DI | 12 | .68 | 30 | 280 | 38 | 280 |
| 10 | 250 | 25 | 18 | .68 | 38 | 340 | 46 | 340 |
| 10 | 350 | DI | 18 | .68 | 38 | 340 | 46 | 340 |
| *10 | 250 | 25 | 24 | .68 | 38 | 400 | 46 | 400 |
| *10 | 350 | DI | 24 | .68 | 38 | 400 | 46 | 400 |
| 12 | 250 | 25 | 6 | .75 | 26 | 320 | 34 | 320 |
| 12 | 350 | DI | 6 | .75 | 26 | 320 | 34 | 320 |
| 12 | 250 | 25 | 12 | .75 | 37 | 420 | 45 | 420 |
| 12 | 350 | DI | 12 | .75 | 37 | 420 | 45 | 420 |
| 12 | 250 | 25 | 18 | .75 | 48 | 520 | 56 | 520 |
| 12 | 350 | DI | 18 | .75 | 48 | 520 | 56 | 520 |

*Not included in AWWA C110.

The user is directed to "off-set capabilities" of deflected pipe and fitting joints as shown elsewhere in this manual.



AMERICAN Mechanical Joint Fittings
ANSI/AWWA C110/A21.10

Offsets

Table No. 12-34 – Continued

| Size in. | Pressure Rating psi | Iron Strength psi (1000's) | D in. | T in. | A-10700 MJ & MJ | | A-10701 MJ & PE | |
|----------|---------------------|----------------------------|-------|-------|-----------------|-----------|-----------------|-----------|
| | | | | | L in. | Weight lb | L in. | Weight lb |
| 14 | 150 | 25 | 6 | .66 | 27 | 380 | 35 | 365 |
| 14 | 250 | 25 | 6 | .82 | 27 | 435 | 35 | 420 |
| 14 | 350 | DI | 6 | .66 | 27 | 380 | 35 | 365 |
| 14 | 150 | 25 | 12 | .66 | 38 | 480 | 46 | 465 |
| 14 | 250 | 25 | 12 | .82 | 38 | 560 | 46 | 545 |
| 14 | 350 | DI | 12 | .66 | 38 | 480 | 46 | 465 |
| 14 | 150 | 25 | 18 | .66 | 49 | 585 | 57 | 570 |
| 14 | 250 | 25 | 18 | .82 | 49 | 680 | 57 | 665 |
| 14 | 350 | DI | 18 | .66 | 49 | 585 | 57 | 570 |
| 16 | 150 | 30 | 6 | .70 | 27 | 460 | 35 | 440 |
| 16 | 250 | 30 | 6 | .89 | 27 | 535 | 35 | 515 |
| 16 | 350 | DI | 6 | .70 | 27 | 460 | 35 | 440 |
| 16 | 150 | 30 | 12 | .70 | 40 | 600 | 48 | 580 |
| 16 | 250 | 30 | 12 | .89 | 40 | 715 | 48 | 690 |
| 16 | 350 | DI | 12 | .70 | 40 | 600 | 48 | 580 |
| 16 | 150 | 30 | 18 | .70 | 50 | 710 | 58 | 690 |
| 16 | 250 | 30 | 18 | .89 | 50 | 850 | 58 | 830 |
| 16 | 350 | DI | 18 | .70 | 50 | 710 | 58 | 690 |
| *16 | 250 | 30 | 24 | .89 | 50 | 1030 | 58 | 1030 |
| *18 | 250 | 30 | 6 | .96 | 28 | 660 | 36 | 670 |
| *18 | 250 | 30 | 12 | .96 | 40 | 865 | 48 | 870 |
| *18 | 250 | 30 | 18 | .96 | 51 | 1055 | 59 | 1060 |
| *20 | 150 | 30 | 6 | .80 | 28 | 670 | 36 | 640 |
| *20 | 250 | DI | 6 | .80 | 28 | 670 | 36 | 640 |
| *20 | 150 | 30 | 12 | .80 | 40 | 855 | 48 | 825 |
| *20 | 250 | DI | 12 | .80 | 40 | 855 | 48 | 825 |
| *20 | 250 | 30 | 18 | 1.03 | 52 | 1275 | 60 | 1275 |
| *24 | 250 | 30 | 6 | 1.16 | 28 | 1040 | 36 | 1045 |
| *24 | 150 | 30 | 12 | .89 | 40 | 1140 | 48 | 1100 |
| *24 | 250 | DI | 12 | .89 | 40 | 1140 | 48 | 1100 |
| *24 | 250 | 30 | 18 | 1.16 | 52 | 1785 | 60 | 1790 |
| *24 | 150 | 30 | 24 | .89 | 48 | 1420 | 56 | 1380 |
| *24 | 250 | DI | 24 | .89 | 48 | 1420 | 56 | 1380 |
| *30 | 150 | 30 | 18 | 1.03 | 56 | 2300 | 64 | 2195 |
| *30 | 250 | DI | 18 | 1.03 | 56 | 2300 | 64 | 2195 |

*Not included in AWWA C110.

AMERICAN could furnish fittings for all of the pressure ratings listed above; however, in some few larger sizes where two thickness/iron options are shown, both thicknesses listed for a particular fitting may not have been available.

AMERICAN HISTORICAL DATA – OBSOLETE PIPING MATERIALS



AMERICAN Specials Blow-Off Branches

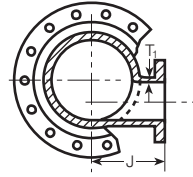
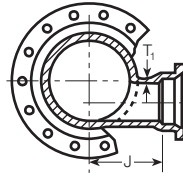
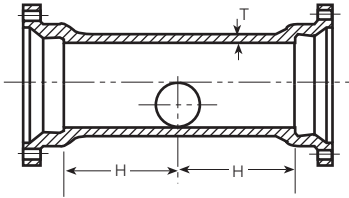

A-10120
All MJ Blow-Off Branch

A-30127
MJ, MJ and Flg
Blow-Off Branch

Table No. 12-35

| Size in. | | Pressure Rating* psi | Iron Strength psi (1000's) | Dimensions in Inches | | | | Weight lb (All MJ) |
|----------|--------|-------------------------|----------------------------------|----------------------|----------------|----|----|--------------------------|
| Run | Branch | | | T | T ₁ | H | J | |
| 6 | 4 | 250 | 30 | .55 | .52 | 12 | 7 | 140 |
| 8 | 4 | 250 | 30 | .60 | .52 | 12 | 7 | 185 |
| 8 | 6 | 250 | 30 | .60 | .55 | 12 | 7 | 190 |
| 10 | 4 | 250 | 30 | .68 | .52 | 12 | 8 | 250 |
| 10 | 6 | 250 | 30 | .68 | .55 | 12 | 8 | 255 |
| 12 | 4 | 250 | 30 | .75 | .52 | 12 | 10 | 310 |
| 12 | 6 | 250 | 30 | .75 | .55 | 12 | 10 | 325 |
| 14 | 4 | 150 | 30 | .66 | .52 | 12 | 11 | 390 |
| 14 | 6 | 150 | 30 | .66 | .55 | 12 | 11 | 395 |
| 16 | 4 | 150 | 30 | .70 | .52 | 12 | 12 | 465 |
| 16 | 6 | 150 | 30 | .70 | .55 | 12 | 12 | 480 |
| 16 | 8 | 150 | 30 | .70 | .60 | 12 | 12 | 495 |
| 18 | 4 | 150 | 30 | .75 | .52 | 12 | 13 | 560 |
| 18 | 6 | 150 | 30 | .75 | .55 | 12 | 13 | 570 |
| 18 | 8 | 150 | 30 | .75 | .60 | 12 | 13 | 580 |
| 20 | 4 | 150 | 30 | .80 | .52 | 12 | 14 | 660 |
| 20 | 6 | 150 | 30 | .80 | .55 | 12 | 14 | 665 |
| 20 | 8 | 150 | 30 | .80 | .60 | 12 | 14 | 675 |
| 24 | 4 | 150 | 30 | .89 | .52 | 12 | 16 | 870 |
| 24 | 6 | 150 | 30 | .89 | .55 | 12 | 16 | 880 |
| 24 | 8 | 150 | 30 | .89 | .60 | 12 | 16 | 890 |
| 30 | 4 | 150 | 30 | 1.03 | .52 | 13 | 20 | 1440 |
| 30 | 6 | 150 | 30 | 1.03 | .55 | 13 | 20 | 1455 |
| 30 | 8 | 150 | 30 | 1.03 | .60 | 13 | 20 | 1470 |
| 30 | 10 | 150 | 30 | 1.03 | .68 | 13 | 20 | 1485 |
| 30 | 12 | 150 | 30 | 1.03 | .75 | 13 | 20 | 1500 |
| 36 | 6 | 150 | 30 | 1.15 | .55 | 13 | 23 | 1990 |
| 36 | 8 | 150 | 30 | 1.15 | .60 | 13 | 23 | 2005 |
| 36 | 10 | 150 | 30 | 1.15 | .68 | 13 | 23 | 2020 |
| 36 | 12 | 150 | 30 | 1.15 | .75 | 13 | 23 | 2040 |
| 42 | 6 | 150 | 30 | 1.28 | .55 | 15 | 26 | 2730 |
| 42 | 8 | 150 | 30 | 1.28 | .60 | 15 | 26 | 2750 |
| 42 | 10 | 150 | 30 | 1.28 | .68 | 15 | 26 | 2770 |
| 42 | 12 | 150 | 30 | 1.28 | .75 | 15 | 26 | 2795 |
| 42 | 16 | 150 | 30 | 1.28 | .70 | 15 | 26 | 2820 |
| 48 | 12 | 150 | 30 | 1.42 | .75 | 17 | 30 | 3775 |
| 48 | 16 | 150 | 30 | 1.42 | .70 | 17 | 30 | 3795 |

*All sizes of Blow-Off Branches could be furnished of ductile iron. The ductile iron 14" through 48" Blow-Off Branches were rated at 250 psi.

Blow-offs may be accomplished using tangential welded-on outlets as shown in Section 7 or by using a tapping saddle and bend combination.



AMERICAN Specials Sludge Shoes

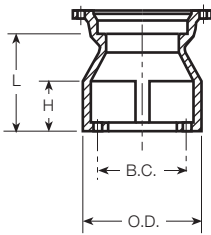

A-10752
MJ Sludge Shoe

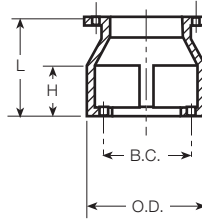

A-30752
Flanged Sludge Shoe

Table No. 12-36

| Size in. | Dimensions in Inches | | | Anchor Bolt Holes | | | Weight in Pounds | |
|----------|----------------------|---------------------|--------------------|-------------------|-----|----------|------------------|-------------|
| | L Laying Length | H Height of Opening | O.D. Shoe Diameter | B.C. Bolt Circle | No. | Size in. | A-10752 MJ | A-30752 Fig |
| 4 | 12 | 6 | 8.50 | 7.00 | 4 | 3/4 | 40 | 35 |
| 6 | 12 | 6 | 9.50 | 7.87 | 4 | 3/4 | 55 | 45 |
| 8 | 12 | 6 | 11.75 | 10.12 | 4 | 3/4 | 75 | 65 |
| 10 | 12 | 6 | 14.00 | 12.25 | 4 | 1 | 100 | 85 |
| 12 | 12 | 6 | 17.00 | 15.25 | 4 | 1 | 130 | 120 |

Fittings were normally gray iron but could be furnished of ductile iron when specified.
Holes for anchor bolts were drilled in base setting ring when specified. Four legs were provided on all sizes.

Tapped and Plain End Adapters

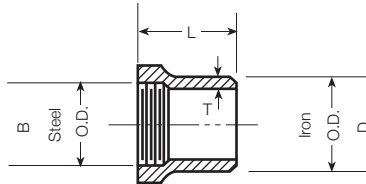

A-35822
Tapped and PE Adapter

Table No. 12-37

| Size in. | Pressure Rating psi | Dimensions in Inches | | | | Weight lb |
|----------|---------------------|----------------------|-------|-------|-----|-----------|
| | | B | D | L | T | |
| 4 | 250 | 4.50 | 4.80 | 9.25 | .52 | 20 |
| 6 | 250 | 6.62 | 6.90 | 9.25 | .55 | 30 |
| 8 | 250 | 8.62 | 9.05 | 12.00 | .60 | 55 |
| 10 | 250 | 10.75 | 11.10 | 12.00 | .68 | 80 |
| 12 | 250 | 12.75 | 13.20 | 12.00 | .75 | 100 |

Fittings were normally gray iron but could be furnished of ductile iron when specified.
Adapters were used to connect steel threaded pipe to ductile iron or gray iron pipe of same nominal size. Plain ends were furnished gaged for Fastite bell.



AMERICAN Ductile Iron Lugged Fastite Joint Materials

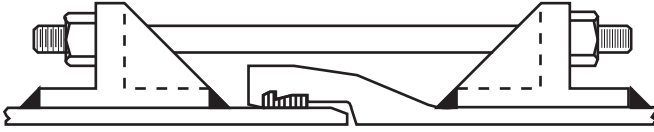

Lugged Fastite Joint

Table No. 12-38

| Size in. | Joint Assembly | | | | Type Lugs | |
|-------------|--------------------|----------------------|--------------------|----------------------|-------------------------------------|--|
| | Pipe to Pipe | | Fitting to Pipe | | Pipe Lug Weight Per Lug lb | Fitting Lug Weight Per Lug lb |
| | Rod Size in. | Rod Weight* lb | Rod Size in. | Rod Weight* lb | | |
| 14 | 1 x 23 | 5.8 | 1 x 14 | 3.8 | 20 | 8 |
| 16 | 1 x 23 | 5.8 | 1 x 14 | 3.8 | 20 | 8 |
| 18 | 1 x 24 | 6.0 | 1 x 14 | 3.8 | 20 | 8 |
| 20 | 1 x 24 | 6.0 | 1 x 14 | 3.8 | 20 | 8 |
| 24 | 1½ x 24 | 9.7 | 1½ x 15 | 6.6 | 20 | 8 |
| 30 | 1½ x 26 | 10.5 | 1½ x 16 | 7.0 | 24 | 9 |
| 36 | 1½ x 26 | 10.5 | 1½ x 16 | 7.0 | 24 | 9 |
| 42 | 1½ x 26 | 10.5 | 1½ x 15 | 6.6 | 25 | 9 |
| 48 | 1½ x 26 | 10.5 | 1½ x 15 | 6.6 | 25 | 9 |
| 54 | 1½ x 26 | 10.5 | 1½ x 15 | 6.6 | 28 | 9 |

*Weight of rod includes weight of two nuts.

Pipe lugs were welded on; fitting lugs were cast on.

See Section 3 for classes (Thickness Class 50, or heavier) and weights of Fastite Ductile Iron Pipe on which lugs were welded. Two, four or six pairs of lugs were furnished on 30"-54" pipe and fittings, and only two or four pairs on 14"-24".

Rods for use in pulling joint together were 5" longer than standard lengths shown above and were furnished only when specifically ordered.

Normal Orientation of Lugs on Pipe and Fittings

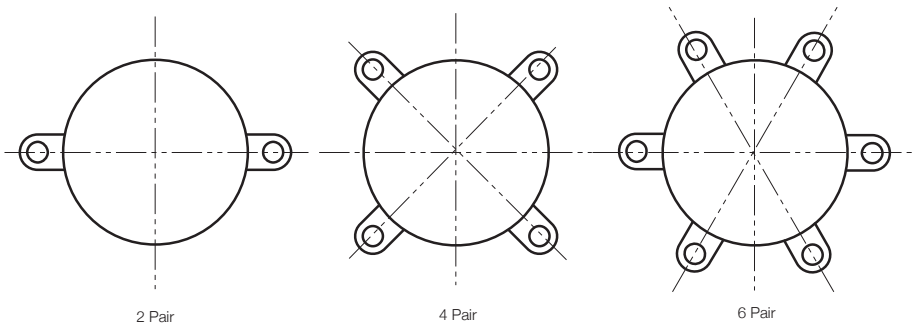



Ductile Iron Mechanical Joint Retainer Glands



Mechanical Joint Retainer Glands—for use with Ductile Iron pipe 3" through 24"—are cast of Ductile Iron, Grade 60-42-10, and equipped with special alloy steel cupped end set screws. They provide restraint against possible separation of unblocked joints due to internal pressure when assembled on AMERICAN Mechanical Joint Pipe or fittings or on other Standardized Mechanical Joints.

A typical application of this Retainer Gland is restraining fire hydrants and their associated valves and hydrant leads against separation due to internal water pressure. These glands provide restrained joint piping that can be cut to suit in the field, eliminating the necessity of special shop fabricated lengths. However, AMERICAN highly recommends the use of improved methods of joint restraint such as Fast-Grip, Flex-Ring, Field Flex-Ring, and Lok-Ring in lieu of retainer glands. These newer restrained joints offer improved performance, reliability, and less labor-intensive installation requirements than retainer glands.

NOTE: The technical data furnished by AMERICAN pertains only to retainer

glands manufactured by AMERICAN and may not apply to those glands manufactured by others but furnished by AMERICAN. Also, we will not warrant retainer glands manufactured by others for use on our piping products, whether furnished by AMERICAN or not. Furthermore, we do not recommend the use of retainer glands on minimum classes of ductile iron pipe.

AMERICAN manufactures 4" through 12" Mechanical Joint Ductile Iron pipe in accordance with AWWA C151 and AWWA C111 and Mechanical Joint fittings up through 48" in accordance with AWWA C153, AWWA C110, and AWWA C111, as described therein. However, AMERICAN does not warrant the performance of third-party mechanical retainer glands or joints using third-party retainer glands, since the design, manufacturing, and installation methods are beyond our control. AMERICAN does manufacture a number of restrained joints such as Fast-Grip®, Flex-Ring®, Field Flex-Ring®, Lok-Ring®, Flex-Lok®, and other devices, where we warrant the joint as well as the associated pipe and fittings of our manufacture.



Ductile Iron Mechanical Joint Retainer Glands

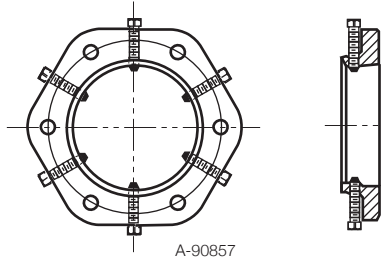

Table No. 12-39

| Size in. | Pressure Rating psi | No. of Set Screws* | Weight lb |
|----------|---------------------|--------------------|-----------|
| 3 | 350 | 4 | 5 |
| 4 | 350 | 4 | 8 |
| 6 | 350 | 6 | 12 |
| 8 | 250 | 9 | 22 |
| 10 | 250 | 16 | 28 |
| 12 | 250 | 16 | 34 |
| **14 | 250 | 20 | 46 |
| **16 | 250 | 24 | 53 |
| **18 | 200 | 24 | 67 |
| **20 | 200 | 28 | 77 |
| **24 | 150 | 32 | 106 |

*All set screws are 5/8" size with cupped ends and 5/8" square heads.

**Sizes 14" through 24" are for installation only on ductile iron pipe or on plain end of ductile iron fitting.

The tee-head bolts for joint assembly for the 3" and 4" MJ Retainer Glands are standard length in accordance with AWWA C111; for 6"-24" sizes, bolts are 1/2" longer than the standard lengths.

Note: Information in this table may not apply to retainer glands furnished by AMERICAN manufactured by others.



Ductile Iron Mechanical Joint Retainer Glands Assembly Instructions*

1. Wash socket and plain end with soapy water. Loosen set screws in gland and slip gland over pipe end. Place gasket on plain end of pipe and thick section of gasket facing gland. Coat gasket with soapy water (Photo 1).

2. Position fitting on plain end of pipe and push gasket into place, making sure it is evenly seated in the socket. Slide gland into position, insert joint bolts and run hex nuts up finger tight (Photo 2).

3. Tighten the mechanical joint tee-head bolts uniformly to the recommended torque: 60 foot-pounds for 3" glands and 90 foot-pounds for 4"-24" glands. Bolts 180° apart should be tightened alternately in order to draw gland up evenly (Photo 3). Bolts for the 3" and 4" Mechanical Joint Retainer Glands are standard length in accordance with ANSI/AWWA C111/A21.11; bolts are $\frac{3}{4}$ " x 4" for 6" glands, $\frac{3}{4}$ " x 4 $\frac{1}{2}$ " for 8"-12" glands, $\frac{3}{4}$ " x 5" for 14"-20" glands, and $\frac{3}{4}$ " x 5 $\frac{1}{2}$ " for 24" glands. These bolts for 6"-24" glands are $\frac{1}{2}$ " longer than standard.

4. Run all set screws down until they are in firm contact with the plain end of the jointed pipe. Tighten set screws progressively once around the joint to approximately 40 foot-pounds torque. Finally, tighten the set screws progressively twice around the joint to the following approximate torques (Photo 4):

3"-12" glands, 80 foot-pounds

14"-24" glands, 65 foot-pounds

This assembly procedure, when properly followed, will provide excellent restraint against joint separation under normal operating conditions.

***Note:** *Assembly instructions for retainer glands furnished by AMERICAN manufactured by others may differ from these.*

Joints using retainer glands should be made in reasonably straight alignment and any deflection necessary should be made before tightening the joint bolts or set screws. See Section 2, Table No. 2-9 for allowable deflection.



1



2



3



4



AMERICAN Ductile Iron Mechanical Joint Pipe

ANSI/AWWA C111/A21.11 Standard Dimensions 14" - 48"

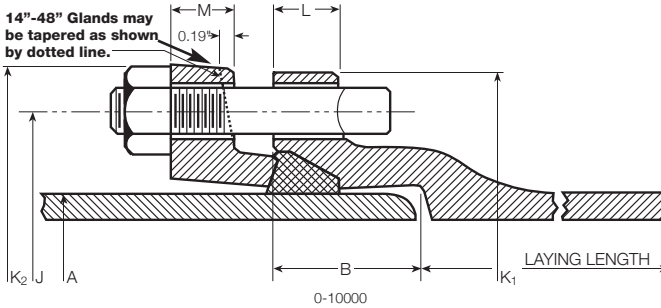

Table No. 12-40

| Size in. | Nominal Laying Length ft. | Dimensions in Inches | | | | | | | Bolts | |
|----------|---------------------------|----------------------|-----|-------|------------------|----------------|------|------|---------------|----------|
| | | A | B | J | K ₁ * | K ₂ | L** | M | No. per Joint | Size in. |
| 14 | 20 | 15.30 | 3.5 | 18.75 | 20.25 | 20.25 | 1.02 | 1.25 | 10 | ¾ X 4½ |
| 16 | 20 | 17.40 | 3.5 | 21.00 | 22.50 | 22.50 | 1.08 | 1.31 | 12 | ¾ X 4½ |
| 18 | 20 | 19.50 | 3.5 | 23.25 | 24.75 | 24.75 | 1.14 | 1.38 | 12 | ¾ X 4½ |
| 20 | 20 | 21.60 | 3.5 | 25.50 | 27.00 | 27.00 | 1.20 | 1.44 | 14 | ¾ X 4½ |
| 24 | 20 | 25.80 | 3.5 | 30.00 | 31.50 | 31.50 | 1.26 | 1.56 | 16 | ¾ X 5 |
| 30 | 20 | 32.00 | 4.0 | 36.88 | 39.12 | 39.12 | 1.38 | 2.00 | 20 | 1 X 6 |
| 36 | 20 | 38.30 | 4.0 | 43.75 | 46.00 | 46.00 | 1.50 | 2.00 | 24 | 1 X 6 |
| 40 | 20 | 44.50 | 4.0 | 50.62 | 53.12 | 53.12 | 1.50 | 2.00 | 28 | 1 ¼ X 6 |
| 48 | 20 | 50.80 | 4.0 | 57.50 | 60.00 | 60.00 | 1.50 | 2.00 | 32 | 1 ¼ X 6 |

*These dimensions for pipe only. Refer to Table No. 5-1 for fitting joint dimensions.

**The bell flanges may be furnished thicker than specified under "L" above as provided in AWWA C111. Bolt holes are ¼" larger than bolt diameters.



AMERICAN Ductile Iron Flex-Ring Joint Pipe

Field-Adaptable Spigot Rings for 4"-12" Flex-Ring Joints

Field closures or other restraint can be made by using AMERICAN's Fast-Grip® gasket, which is available in 4"-16" sizes (See page 9-2) or AMERICAN's Field Flex-Ring in the 14"-36" sizes. (See page 9-16).

4"-12" AMERICAN Flex-Ring Joints may also be made field-adaptable* by the use of ductile iron set-screw spigot rings especially designed for this purpose. Where field cuts are anticipated, the ring may be provided in lieu of the factory welded-on spigot ring of the regular Flex-Ring Joint. With the aid of this product and an Allen wrench, a strong, depend-

able restrained joint system, rated for 350 psi working pressure, may be completed without the need for elaborate tools, equipment, or highly specialized labor.

The field-adaptable spigot ring is manufactured from annealed ductile iron. Table No. 9-3 shows the number of Allen head, cup point set screws required for each pipe size.

*Note: It may be possible to avoid field cuts altogether in the restrained joint segment of the pipeline. One way to accomplish this in some situations is by measuring ahead and making the field cut in the unrestrained portion.

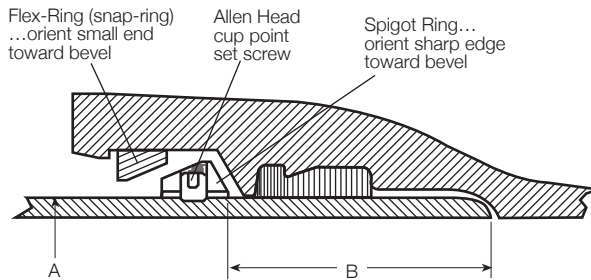

Table No.12-41

| Pipe Size in. | A Nominal Pipe O.D. in. | B In. (± 1/16") | Number Allen Head Set Screws |
|---------------|-------------------------|-----------------|------------------------------|
| 4 | 4.80 | 3.56 | 6 |
| 6 | 6.90 | 3.56 | 8 |
| 8 | 9.05 | 3.69 | 12 |
| 10 | 11.10 | 4.25 | 18 |
| 12 | 13.20 | 4.25 | 24 |



AMERICAN Ductile Iron Flex-Ring Joint Pipe Hinged Locking Ring Style 14"-36"

In the period from approximately 1985-1996, 14"-36" Flex-Ring pipe was manufactured with a hinged locking ring which closed into locking position on the spigot by virtue of a strong, stainless steel spring attached to the locking ring ends (instead of the current rubber-backed, flex-ring design as shown in Section 9). The pipe bell and spigots are exactly the

same, meaning former or current locking ring designs can be used interchangeably in former or current joints, providing proper assembly procedure for the respective locking ring designs is followed. What follows is a description of the assembly and disassembly procedures for joints with the hinged/spring locking ring design.

Assembly Instructions



1. Remove screws and slotted shipping plate from the segmented ring ends inside the bell. (The Flex-Ring Joint is normally shipped with the joint locking ring in place for assembly.)

2. Clean the socket and insert the gasket. (Note: Flex-Ring Joints use standard Fastite gaskets.) Clean the outside of the spigot end from the end of the pipe to the assembly stripe. Apply a thin film of regular American Fastite Joint Lubricant (or special underwater lubricant recommended for underwater or very wet trench installations) to the outside pipe surface between the weld bead and the end of the pipe and also to the inside surface of the inserted gasket.

With the pipes in reasonably straight alignment, insert the spigot completely into the socket per normal Fastite Joint assembly procedure (see Section 2). The orientation of the spigot stripe relative to

the bell face is an indication of pipe alignment. The spigot stripe will pass into the bell during correct joint assembly.

3. Remove the clip between the ring ends and away from the face of the bell, allowing the ring to close firmly onto the barrel of the pipe. Verify the correct positioning of the assembled ring by visual inspection (or by "feeler" gauge if installed in conditions of poor visibility). The ring will normally spring directly into the correct assembled position. However, if the ring should not come down firmly onto the pipe at any location, deflect the pipe slightly in that direction, and/or move the locking ring with a wire hook inserted in the end of the spring, thereby causing the ring to seat itself correctly.

After joint assembly, deflect the joint, if required, within the range of allowable joint deflection for the size of pipe being assembled.



AMERICAN Ductile Iron Flex-Ring Joint Pipe Assembly Instructions 14"-36"

DISASSEMBLY OF 14"-36" FLEX-RING

The AMERICAN Flex-Ring Joint may easily be disassembled if the need arises. If the joint has been extended to the locked position, it will be necessary to push or pull the spigot completely to the rear of the socket to accomplish disassembly. Once the spigot is in this position, shims* with a thickness roughly equal to the weld height should be driven between the ring segments and the pipe spigot and up to (but not over) the weld bead as shown above. Sufficient numbers and spacing of disassembly shims should be used to allow the weld bead to pass underneath the segments and connecting spring and out of the socket. One shim should be located under the center of the spring to prevent spring deformation or damage during disassembly. Once disassembly shims have been placed (with the pipes in reasonably straight alignment) the spigot should be pulled or jacked out of the socket.



* Although special disassembly shims can be furnished by AMERICAN upon request, shims of virtually any suitable material, shape, and approximate thickness of the weld height may be used effectively to disassemble the joint.



FIELD ASSEMBLY OF SEGMENTED FLEX-RING

The segmented flex-ring is normally shipped in the bell for the convenience of the installer. Should it be necessary to install a Flex-Ring in the socket in the field, this may be accomplished per the following procedure:

Field Assembly of Loose 14"-36" Flex-Rings in Socket

1. Clean the socket ring cavity and Flex-Ring.
2. Insert the loose Flex-Ring into the socket ring cavity in "gasket-like" fashion.
3. Using a large C-clamp, firmly clamp one end segment of the ring to the bell (Photo A).

**4. Thread a common $\frac{5}{16}$ " U.N.C. eye-bolt substantially into the threaded hole of the opposite end segment and, grasping the eye-bolt, spread the ring ends apart sufficiently to allow insertion of the bell clip (Photo B).

**5. Quickly spread the limbs of the bell clip to allow wedging of the bell clip over the bell restraining shoulder and spring, with the inner limb of the bell clip positioned between the ends of the segmented ring. When this is performed, the center of the spring should be between the inner limb of the bell clip and the inner socket surface (as in the case of factory ring assembly). The locking ring is then in proper position for joint assembly.

** In operations (4) and (5) above, take care to securely hold members to avoid "pinching fingers" under strong spring action.



AMERICAN Ductile Iron Lok-Ring® Joint Pipe 14"-36"

Centrifugally Cast for Water, Sewage or Other Liquids

AMERICAN Lok-Ring Pipe is ductile iron, grade 60-42-10, manufactured and tested in accordance with AWWA C151. It is normally furnished standard asphaltic coated outside and cement lined in accordance with AWWA C104. When specified, other special coatings or linings can be furnished as described in Section 11.

A full complement of AMERICAN Lok-Ring ductile iron fittings is available.

These fittings are available in both bell-bell and bell-plain end configurations for installation versatility and economy. Lok-Ring fittings meet applicable requirements of ANSI/AWWA C110/A21.10 or ANSI/AWWA C153/A21.53 and are pressure rated for at least 250 psi in most configurations. Check AMERICAN if higher pressure required. See Section 4.

Standard Dimensions

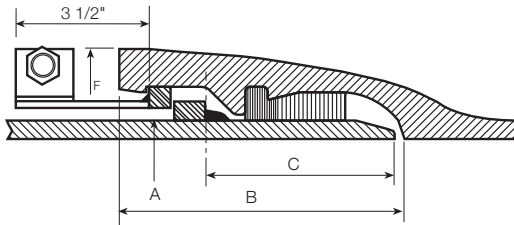

Table No. 12-42

| Size in. | Working Pressure* psi | Nominal Laying Length** ft. | A Outside Diameter in. | B Socket Depth in. | C Plain End to Retaining Ring in. | F Bell O.D.† in. | Retainer Ring | Lok-Ring |
|----------|-----------------------|-----------------------------|------------------------|--------------------|-----------------------------------|------------------|---------------|----------|
| 14 | 350 | 20 | 15.30 | 5.81 | 3.87 | 18.13 | ½" sq. | ½" sq. |
| 16 | 350 | 20 | 17.40 | 5.81 | 3.87 | 20.25 | ½" sq. | ½" sq. |
| 18 | 350 | 20 | 19.50 | 6.15 | 4.14 | 22.50 | ½" sq. | ½" sq. |
| 20 | 350 | 20 | 21.60 | 6.15 | 4.14 | 24.63 | ½" sq. | ½" sq. |
| 24 | 350 | 20 | 25.80 | 6.15 | 4.14 | 28.88 | ½" sq. | ½" sq. |
| 30 | 250 | 20 | 32.00 | 7.45 | 5.00 | 36.00 | ¾" sq. | ¾" sq. |
| 36 | 250 | 20 | 38.30 | 7.45 | 5.00 | 42.63 | ¾" sq. | ¾" sq. |

*Working pressure is the maximum pressure rating of the joint and is based on its capability to resist thrust due to internal pressure.

**Laying length is nominal 20 feet. Where exact lengths are required, contact AMERICAN. (See minimum laying lengths tabulated below.)

†Dimensions subject to change at our option. Check AMERICAN if smaller or exact dimensions required.



AMERICAN Ductile Iron Specials Welded-On Bosses for Ductile Iron Pipe

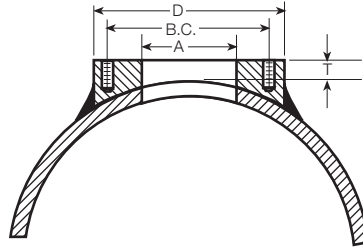

A-96946
Welded-On Boss Faced and Tapped
for AWWA C110 or C115 Flange Connection

Table No. 12-43

| A Dia. of Bosset Outlet Nominal Size in. | Parent Pipe | | Boss Water Working Pressure psi | Boss | | | Studs** | |
|--|---------------------|---------------------------|---|------------------|-------------------------------|-----------------------------|---------------|-------------|
| | Min. Dia. in. | Min. Pressure Class | | D Dia. in. | T Min. Thickness in. | BC Bolt Circle in. | No. Req'd. | Size in. |
| 2* | 6 | 350 | 250 | 6.0 | 1.00 | 4.75 | 4 | ¾ x 2½ |
| 3 | 10 | 350 | 250 | 7.5 | 1.00 | 6.00 | 4 | ¾ x 2½ |
| 4 | 12 | 350 | 250 | 9.0 | 1.00 | 7.50 | 8 | ¾ x 3 |
| 6 | 16 | 250 | 250 | 11.0 | 1.25 | 9.50 | 8 | ¾ x 3½ |
| 8 | 18 | 250 | 250 | 13.5 | 1.25 | 11.75 | 8 | ¾ x 3½ |
| 10 | 24 | 250 | 250 | 16.0 | 1.25 | 14.25 | 12 | ¾ x 4 |
| 12 | 30 | 250 | 250 | 19.0 | 1.25 | 17.00 | 12 | ¾ x 4 |
| 14 | 30 | 250 | 250 | 21.0 | 1.50 | 18.75 | 12 | 1 x 4½ |
| 16 | 36 | 250 | 250 | 23.5 | 1.50 | 21.25 | 16 | 1 x 4½ |
| 18 | 36 | 250 | 250 | 25.0 | 1.75 | 22.75 | 16 | 1½ x 5 |
| 20 | 42 | 350 | 250 | 27.5 | 2.00 | 25.00 | 20 | 1½ x 5 |
| 24 | 48 | 350 | 250 | 32.0 | 2.25 | 29.50 | 20 | 1½ x 5½ |

*Not included in AWWA C110.

**Shown for information only. Joint materials are not routinely furnished for flanged connections, although AMERICAN Toruseal® flange gaskets are available and recommended for optimum joint assembly and security.

Dimensions for ANSI B16.1 Class 250 flange connection can be furnished on request.

Bosses must be located a minimum of 1/2 Boss Diameter (D) plus 10" from 4"-16" threaded flanges and 1/2 Boss Diameter (D) plus 14" from 18"-64" threaded flanges. (Note: Dimensions are stated from centerline of boss to face of flange.) Bosses welded on pipe other than flange pipe should be located a minimum of 6'-0" from the plain end and 3'-0" from the bell end of the pipe. (Note: Dimensions are stated from centerline of boss to extreme ends of pipe.)

Where flanged outlet bosses must be installed underground, system design and installation should be such so as to avoid bending loads on the flanged joints and/or bosses. It may be necessary in such cases to locate a flexible joint very close to the boss. The Appendix to ANSI/AWWA C115/A21.15 notes that underground use of the flanged joint is generally not recommended because of the rigidity of the joint.

This is a shop fabricated product and is not intended for field fabrication.

AMERICAN HISTORICAL DATA — OBSOLETE PIPING MATERIALS



AMERICAN Ductile Iron Specials

Welded-On Bosses for Ductile Iron Pipe

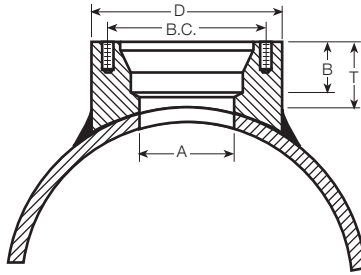

A-96945
Welded-On Boss Drilled and Tapped
for AWWA C111 Mechanical Joint Connection

Table No. 12-44

| A Dia. of Bossed Outlet Nominal Size in. | Parent Pipe | | Boss Water Working Pressure psi | Boss | | | | Studs | |
|--|---------------------|---------------------------|---|------------------|-------------------------------|-----------------------------|-----------------------------|---------------|-------------|
| | Min. Dia. in. | Min. Pressure Class | | D Dia. in. | T Min. Thickness in. | B Socket Depth in. | BC Bolt Circle in. | No. Req'd. | Size in. |
| 4 | 12 | 350 | 250 | 9.12 | 3.50 | 2.50 | 7.50 | 4 | ¾ x 3½ |
| 6 | 16 | 250 | 250 | 11.12 | 3.50 | 2.50 | 9.50 | 6 | ¾ x 3½ |
| 8 | 18 | 250 | 250 | 13.37 | 3.50 | 2.50 | 11.75 | 6 | ¾ x 4 |
| 10 | 24 | 250 | 250 | 15.75 | 3.50 | 2.50 | 14.00 | 8 | ¾ x 4 |
| 12 | 30 | 250 | 250 | 18.00 | 3.50 | 2.50 | 16.25 | 8 | ¾ x 4 |
| 14 | 30 | 250 | 250 | 20.50 | 4.50 | 3.50 | 18.75 | 10 | ¾ x 4½ |
| 16 | 36 | 250 | 250 | 22.75 | 4.50 | 3.50 | 21.00 | 12 | ¾ x 4½ |
| 18 | 36 | 250 | 250 | 25.12 | 4.50 | 3.50 | 23.25 | 12 | ¾ x 4½ |
| 20 | 42 | 350 | 250 | 27.38 | 4.50 | 3.50 | 25.50 | 14 | ¾ x 4½ |
| 24 | 48 | 350 | 250 | 31.88 | 4.50 | 3.50 | 30.00 | 16 | ¾ x 5 |

AMERICAN regularly furnished pipe with welded-on bosses for proven effectiveness and simplicity of layout and installation. Bosses were positioned circumferentially by rotating the pipe. Normally, they should be positioned at the center of the pipe length. In cases where more precise longitudinal placement is necessary, the boss can be positioned anywhere along the pipe barrel within the following limitations: Bosses must be located a minimum of 1/2 Boss Diameter (D) plus 10" from 4"-16" threaded flanges and 1/2 Boss Diameter (D) plus 14" from 18"-64" threaded flanges. (Note: Dimensions are stated from centerline of boss to face of flange.) Bosses welded on pipe other than flange pipe should be located a minimum of 6'-0" from the plain end and 3'-0" from the bell end of the pipe. (Note: Dimensions are stated from centerline of boss to extreme ends of pipe.)

This is a shop fabricated product and is not intended for field fabrication.



AMERICAN

DUCTILE IRON PIPE

THE RIGHT WAY

AMERICAN Engineering Data





Section 17 - Engineering Data Table of Contents

| | |
|--|---------------|
| Energy Savings With Ductile Iron Pipe..... | 17-2 |
| Present Value of Money | 17-3 |
| Flow of Water in Ductile Iron Pipe | 17-4 |
| Flow of Water in Ductile Iron Pipe (Table 17-1) | 17-5 - 17-8 |
| Gravity Flow in Pipe Manning Formula (Fig. 17-1) | 17-9 |
| Equivalent Pipe Diameters (Table 17-2)..... | 17-10 |
| Equivalent Number of Pipelines (Table 17-3) | 17-11 |
| Diameters, Circumferences, Areas and Volumes for Standard Minimum Pressure Classes of Ductile Iron Cement-Lined Pipe (Table 17-4) | 17-12 |
| Weights for Pipeline Design, Weights of Ductile Iron Pipe and Contained Water (Table 17-5) | 17-12 |
| Axial Bulkhead or Dead-End Thrust Due to Pressure (Table 17-6)..... | 17-13 |
| Standard Abbreviations and Acronyms (Table 17-7) | 17-14 - 17-20 |
| Taps in Ductile Iron Pipe - Minimum Distances (Table 17-8) | 17-21 |
| Standard Pipe Taps - Outside Diameters (Table 17-9) | 17-21 |
| Taps in Ductile Iron Pipe - ANSI/ASME B1.20.1 (Table 17-10)..... | 17-22 |
| Taps in Ductile Iron Pipe - AWWA C800 Standard (Table 17-11) | 17-23 |
| Linear Expansion of Ductile Iron Pipe (Table 17-12) | 17-24 |
| Pipe Length Calculations for Offset Connections (Table 17-13)..... | 17-25 |
| Pipe Length Calculations for Inclined Diagonal Runs..... | 17-26 |
| Mathematical Formulas..... | 17-27 - 17-29 |
| AMERICAN's Standard Color Codes..... | 17-30 |
| Decimal of an Inch and of a Foot (Table 17-14) | 17-31 |
| Equivalents and Conversion Factors - English (Table 17-15) | 17-32, 33 |
| Equivalents and Conversion Factors - Metric (Table 17-16) | 17-34, 35 |



Energy Savings With Ductile Iron Pipe

All sizes of standard thickness cement-lined ductile iron pipe in minimum pressure classes and all special thickness classes through Special Thickness Class 52 in 4"-54" sizes have greater than nominal inside diameters. **Head losses in piping are directly related to inside diameters, and energy consumption and accompanying pumping costs are directly related to head losses. Therefore, the use of ductile iron piping having inside diameters greater than nominal can result in significant energy savings over the years. In addition to helping to keep operating costs and utility rates reasonable, this conservation of energy is also helpful to the environment.**

Graphs and tables pertaining to this can be found in "Manual For Computation of Energy Savings With Ductile Iron Pipe" published by the Ductile Iron Pipe Research Association (DIPRA). Formulas for calculating pumping costs are as follows:

$$PC = 1.65 H_L Q \frac{a}{E}$$

where:

PC = Pumping cost in \$/Year/
1000 ft of pipe based on 24
Hr./day Pump Operation

H_L = Hydraulic Gradient or Head Loss in
ft/1000 ft.

Q = Flow in Gallons/Minute (GPM)

a = Unit Cost of Electricity in \$/KWH

E = Total Efficiency of Pump System
(pump, motor, transmission —
always a number less than one)

$$\text{and: } H_L^* = 1000 \left[\frac{V}{1.318C (r)^{0.63}} \right]^{1.852}$$

where:

V = Velocity in ft/sec (fps)

C = Hazen-Williams "C" Factor
(140 for ductile iron pipe)**

r = Hydraulic Radius in ft (inside diameter
in ft ÷ 4 for pipe flowing full)

and:

$$V^* = \frac{Q}{448.8A}$$

where:

Q = Flow in Gallons/Minute (GPM)

A = Cross sectional area of pipe in ft²

and:

$$A^{***} = \frac{\pi d^2}{4}$$

where:

d^{***} = Inside diameter in ft

*See Table No. 17-1 for values of H_L and V for standard minimum pressure class cement-lined ductile iron pipe.

**The Hazen-Williams flow coefficient C=140 has been used for cement-lined cast iron and ductile iron pipe for many years. The quality of recent, high-performance cement linings for ductile iron pipe, smooth proprietary linings, and the availability of even larger pipe sizes may justify the use of significantly higher values for C. This may be particularly applicable to the intermediate and larger pipe sizes in clean water service. (See pg 17-4.)

***See Table No. 17-4 for values of A and d for standard minimum pressure class cement-lined ductile iron pipe.



Present Value of Money

The present value of money compounded annually at a given investment rate and an assumed inflation rate over a given period can be calculated by the following formulas:

$$PV = \frac{(1 + i)^n - 1}{i(1 + i)^n}$$

where:

PV = Present Value per \$1

i = Effective interest rate (%/100)

n = Number of compounding periods (years)

$$\text{and } i = \frac{j - i'}{1 + i'}$$

where:

j = Investment rate (%/100)

i' = Inflation rate (%/100)

Example:

Given:

50,000' 36" Pressure Class 150 pipe

Design flow — 14,000 GPM

Unit Power Cost — \$.05 KWH

Pump Operation — 24 Hrs/Day

Pump System Efficiency — 70%

Hazen-Williams "C" Factor — 140

Using the Pumping Cost formula on page 17-2, Pressure Class 150, cement-lined, ductile iron pipe will save approximately \$18,075/year in pumping costs over a substitute material pipe with a nominal inside diameter.

The present value of the \$18,075 annual savings, over a 50-year time period, and assuming an investment rate of 8% and an inflation rate of 4%, is \$397,650 (\$18,075 x 22).



Flow of Water In Ductile Iron Pipe

The carrying capacity of a given pipeline is limited by its internal resistance to the flow of water. This resistance to flow causes a loss of head or drop in pressure as the water moves through the line. The amount of head loss depends on (1) the velocity of the water, (2) the roughness of the interior surface of the pipe, (3) the internal diameter, and (4) the length of the line. These factors have been related in the widely used Hazen-Williams formula for computing head losses, pipe sizes and carrying capacities in distribution lines. This formula is as follows:

$$V = C \times r^{0.63} \times S^{0.54} \times 0.001^{-0.04}$$

in which

V = velocity of water through the pipe in feet per second

C = factor depending on the roughness of the interior surface

r = hydraulic radius which is 1/4 the internal diameter (for pipe flowing full), in feet

S = hydraulic slope or head loss in feet per foot of pipe

The factor C is well known as the Hazen-Williams "C" or flow coefficient "C," and its value must be estimated in flow calculations.

Numerous tests have shown that cement-lined pipe installed many years ago maintains a nearly constant "C" of 140 even in tuberculating waters. The quality of more recent, high-performance AMERICAN cement linings and the availability of even larger pipe sizes may justify the use of significantly higher values for C, particularly in intermediate and larger pipe sizes. Multiple hydraulic flow tests of 42" AMERICAN "high performance" cement-mortar-lined pipeline (with standard, high-speed spun cement lining for that pipe size) conducted in 2001 at the flow facility at Utah State University resulted in an experimentally determined average "C" value slightly greater than 152, with flow velocities in the 3-13 fps (1-4 m/sec) range. A range of Mannings "n" values of 0.0089-0.010 for clean water was also determined for this same high-performance cement lining in this same 42" Utah State testing program. The Utah State data also showed the resulting Darcy friction factors "f" for the high-performance cement lining, when plotted vs. Reynolds number, very closely approximate the "smooth pipe curve" as shown on the Moody diagram.



Flow of Water in Ductile Iron Pipe Hazen-Williams C=140*

Loss of head shown is per 1,000 feet of pipeline. Table is based on 4"-64" AWWA C104 single-thickness cement-lined ductile iron pipe. Nominal thickness for minimum standard pressure classes noted.

Table No. 17-1

| Flow in Gallons per 24 Hours | 4" Pipe, Class 350 | | 6" Pipe, Class 350 | | 8" Pipe, Class 350 | | 10" Pipe, Class 350 | | 12" Pipe, Class 350 | |
|------------------------------|----------------------|-------------------|----------------------|-------------------|----------------------|-------------------|----------------------|-------------------|----------------------|-------------------|
| | Vel. in ft. per sec. | Loss of Head (ft) | Vel. in ft. per sec. | Loss of Head (ft) | Vel. in ft. per sec. | Loss of Head (ft) | Vel. in ft. per sec. | Loss of Head (ft) | Vel. in ft. per sec. | Loss of Head (ft) |
| 20,000 | .33 | .14 | | | | | | | | |
| 30,000 | .49 | .29 | | | | | | | | |
| 40,000 | .65 | .50 | | | | | | | | |
| 50,000 | .81 | .75 | .36 | .10 | | | | | | |
| 60,000 | .98 | 1.05 | .43 | .14 | | | | | | |
| 70,000 | 1.14 | 1.40 | .50 | .19 | | | | | | |
| 80,000 | 1.30 | 1.79 | .58 | .25 | | | | | | |
| 90,000 | 1.46 | 2.23 | .65 | .31 | | | | | | |
| 100,000 | 1.63 | 2.71 | .72 | .37 | | | | | | |
| 110,000 | 1.79 | 3.23 | .79 | .44 | | | | | | |
| 120,000 | 1.95 | 3.79 | .86 | .52 | | | | | | |
| 140,000 | 2.28 | 5.05 | 1.01 | .69 | | | | | | |
| 160,000 | 2.60 | 6.46 | 1.15 | .89 | | | | | | |
| 180,000 | 2.93 | 8.04 | 1.30 | 1.11 | | | | | | |
| 200,000 | 3.25 | 9.77 | 1.44 | 1.34 | .80 | .32 | | | | |
| 220,000 | 3.58 | 11.66 | 1.58 | 1.60 | .88 | .38 | | | | |
| 240,000 | 3.91 | 13.70 | 1.73 | 1.88 | .96 | .45 | | | | |
| 260,000 | 4.23 | 15.88 | 1.87 | 2.18 | 1.04 | .52 | | | | |
| 280,000 | 4.56 | 18.22 | 2.02 | 2.50 | 1.12 | .60 | | | | |
| 300,000 | 4.88 | 20.70 | 2.16 | 2.85 | 1.20 | .68 | .78 | .24 | .54 | .10 |
| 320,000 | 5.21 | 23.33 | 2.31 | 3.21 | 1.28 | .76 | .83 | .27 | .58 | .11 |
| 340,000 | 5.53 | 26.11 | 2.45 | 3.59 | 1.36 | .85 | .88 | .30 | .62 | .12 |
| 360,000 | 5.86 | 29.02 | 2.59 | 3.99 | 1.44 | .95 | .93 | .33 | .65 | .14 |
| 380,000 | 6.18 | 32.08 | 2.74 | 4.41 | 1.52 | 1.05 | .99 | .37 | .69 | .15 |
| 400,000 | 6.51 | 35.27 | 2.88 | 4.85 | 1.60 | 1.15 | 1.04 | .40 | .72 | .17 |
| 450,000 | 7.32 | 43.87 | 3.24 | 6.03 | 1.80 | 1.44 | 1.17 | .50 | .82 | .21 |
| 500,000 | 8.14 | 53.32 | 3.60 | 7.33 | 2.00 | 1.75 | 1.30 | .61 | .91 | .25 |
| 550,000 | 8.95 | 63.61 | 3.96 | 8.74 | 2.20 | 2.08 | 1.43 | .73 | 1.00 | .30 |
| 600,000 | 9.76 | 74.74 | 4.32 | 10.27 | 2.40 | 2.45 | 1.56 | .85 | 1.09 | .36 |
| 650,000 | 10.58 | 86.68 | 4.68 | 11.91 | 2.60 | 2.84 | 1.69 | .99 | 1.18 | .41 |
| 700,000 | | | 5.04 | 13.67 | 2.80 | 3.25 | 1.82 | 1.14 | 1.27 | .47 |
| 750,000 | | | 5.40 | 15.53 | 3.00 | 3.70 | 1.95 | 1.29 | 1.36 | .54 |
| 800,000 | | | 5.76 | 17.50 | 3.20 | 4.17 | 2.08 | 1.46 | 1.45 | .61 |
| 900,000 | | | 6.48 | 21.77 | 3.60 | 5.18 | 2.34 | 1.81 | 1.63 | .75 |
| 1,000,000 | | | 7.20 | 26.46 | 4.00 | 6.30 | 2.60 | 2.20 | 1.81 | .92 |
| 1,200,000 | | | 8.65 | 37.08 | 4.80 | 8.83 | 3.11 | 3.09 | 2.17 | 1.29 |
| 1,400,000 | | | 10.09 | 49.33 | 5.60 | 11.75 | 3.63 | 4.10 | 2.54 | 1.71 |
| 1,600,000 | | | | | 6.39 | 15.04 | 4.15 | 5.26 | 2.90 | 2.19 |
| 1,800,000 | | | | | 7.19 | 18.71 | 4.67 | 6.54 | 3.26 | 2.72 |
| 2,000,000 | | | | | 7.99 | 22.74 | 5.19 | 7.95 | 3.62 | 3.31 |
| 2,200,000 | | | | | 8.79 | 27.13 | 5.71 | 9.48 | 3.98 | 3.95 |
| 2,400,000 | | | | | 9.59 | 31.87 | 6.23 | 11.14 | 4.35 | 4.64 |
| 2,600,000 | | | | | 10.39 | 36.96 | 6.75 | 12.92 | 4.71 | 5.38 |
| 2,800,000 | | | | | | | 7.27 | 14.82 | 5.07 | 6.17 |
| 3,000,000 | | | | | | | 7.79 | 16.84 | 5.43 | 7.01 |
| 3,500,000 | | | | | | | 9.08 | 22.40 | 6.34 | 9.33 |
| 4,000,000 | | | | | | | 10.38 | 28.68 | 7.24 | 11.95 |
| 4,500,000 | | | | | | | | | 8.15 | 14.86 |
| 5,000,000 | | | | | | | | | 9.06 | 18.06 |
| 5,500,000 | | | | | | | | | 9.96 | 21.54 |
| 6,000,000 | | | | | | | | | 10.87 | 25.31 |

*The Hazen-Williams flow coefficient C=140 has been used for cement-lined cast iron and ductile iron pipe for many years. The quality of recent high-performance cement lining for ductile iron pipe and the availability of even larger pipe sizes may justify the use of significantly higher values for C, particularly in the intermediate and larger pipe sizes. (See pg 17-4.)

The design of systems outside common water velocities, i.e. 2-5 fps, may involve special design considerations (for example, the generation of substantial surge pressures as a result of valve closure or other water column effects, sedimentation at extremely low velocities, etc.).



Flow of Water in Ductile Iron Pipe Hazen-Williams C=140*

Loss of head shown is per 1,000 feet of pipeline. Table is based on 4"–64" AWWA C104 single-thickness cement-lined ductile iron pipe. Nominal thickness for minimum standard pressure classes noted.

Table No. 17-1—Continued

| Flow in Gallons per 24 Hours | 14" Pipe, Class 250 | | 16" Pipe, Class 250 | | 18" Pipe, Class 250 | | 20" Pipe, Class 250 | |
|------------------------------|----------------------|-------------------|----------------------|-------------------|----------------------|-------------------|----------------------|-------------------|
| | Vel. in ft. per sec. | Loss of Head (ft) | Vel. in ft. per sec. | Loss of Head (ft) | Vel. in ft. per sec. | Loss of Head (ft) | Vel. in ft. per sec. | Loss of Head (ft) |
| 300,000 | .40 | .05 | | | | | | |
| 400,000 | .54 | .08 | .41 | .04 | .32 | .02 | | |
| 500,000 | .67 | .12 | .51 | .06 | .41 | .04 | | |
| 600,000 | .80 | .17 | .62 | .09 | .49 | .05 | .40 | .03 |
| 700,000 | .94 | .23 | .72 | .12 | .57 | .07 | .46 | .04 |
| 800,000 | 1.07 | .29 | .82 | .15 | .65 | .09 | .53 | .05 |
| 900,000 | 1.21 | .36 | .93 | .19 | .73 | .11 | .59 | .06 |
| 1,000,000 | 1.34 | .44 | 1.03 | .23 | .81 | .13 | .66 | .08 |
| 1,100,000 | 1.47 | .52 | 1.13 | .28 | .89 | .15 | .72 | .09 |
| 1,200,000 | 1.61 | .62 | 1.23 | .32 | .97 | .18 | .79 | .11 |
| 1,300,000 | 1.74 | .71 | 1.34 | .38 | 1.06 | .21 | .86 | .13 |
| 1,400,000 | 1.88 | .82 | 1.44 | .43 | 1.14 | .24 | .92 | .15 |
| 1,500,000 | 2.01 | .93 | 1.54 | .49 | 1.22 | .28 | .99 | .17 |
| 1,600,000 | 2.14 | 1.05 | 1.64 | .55 | 1.30 | .31 | 1.05 | .19 |
| 1,700,000 | 2.28 | 1.17 | 1.75 | .62 | 1.38 | .35 | 1.12 | .21 |
| 1,800,000 | 2.41 | 1.31 | 1.85 | .69 | 1.46 | .39 | 1.19 | .23 |
| 1,900,000 | 2.55 | 1.44 | 1.95 | .76 | 1.54 | .43 | 1.25 | .26 |
| 2,000,000 | 2.68 | 1.59 | 2.06 | .83 | 1.62 | .47 | 1.32 | .28 |
| 2,200,000 | 2.95 | 1.89 | 2.26 | .99 | 1.79 | .56 | 1.45 | .34 |
| 2,400,000 | 3.21 | 2.23 | 2.47 | 1.17 | 1.95 | .66 | 1.58 | .40 |
| 2,500,000 | 3.35 | 2.40 | 2.57 | 1.26 | 2.03 | .71 | 1.65 | .43 |
| 2,600,000 | 3.48 | 2.58 | 2.67 | 1.35 | 2.11 | .76 | 1.71 | .46 |
| 2,800,000 | 3.75 | 2.96 | 2.88 | 1.55 | 2.27 | .87 | 1.84 | .53 |
| 3,000,000 | 4.02 | 3.36 | 3.08 | 1.76 | 2.44 | .99 | 1.98 | .60 |
| 3,500,000 | 4.69 | 4.47 | 3.60 | 2.35 | 2.84 | 1.32 | 2.31 | .79 |
| 4,000,000 | 5.36 | 5.73 | 4.11 | 3.01 | 3.25 | 1.69 | 2.63 | 1.02 |
| 4,500,000 | 6.03 | 7.13 | 4.63 | 3.74 | 3.65 | 2.11 | 2.96 | 1.27 |
| 5,000,000 | 6.70 | 8.66 | 5.14 | 4.55 | 4.06 | 2.56 | 3.29 | 1.54 |
| 5,500,000 | 7.37 | 10.33 | 5.65 | 5.42 | 4.47 | 3.05 | 3.62 | 1.83 |
| 6,000,000 | 8.04 | 12.14 | 6.17 | 6.37 | 4.87 | 3.59 | 3.95 | 2.16 |
| 6,500,000 | 8.71 | 14.08 | 6.68 | 7.39 | 5.28 | 4.16 | 4.28 | 2.50 |
| 7,000,000 | 9.38 | 16.15 | 7.19 | 8.48 | 5.68 | 4.77 | 4.61 | 2.87 |
| 7,500,000 | 10.05 | 18.35 | 7.71 | 9.63 | 6.09 | 5.42 | 4.94 | 3.26 |
| 8,000,000 | | | 8.22 | 10.85 | 6.49 | 6.11 | 5.27 | 3.67 |
| 8,500,000 | | | 8.74 | 12.14 | 6.90 | 6.84 | 5.60 | 4.11 |
| 9,000,000 | | | 9.25 | 13.50 | 7.31 | 7.60 | 5.93 | 4.57 |
| 9,500,000 | | | 9.76 | 14.92 | 7.71 | 8.40 | 6.26 | 5.05 |
| 10,000,000 | | | 10.28 | 16.41 | 8.12 | 9.24 | 6.59 | 5.55 |
| 11,000,000 | | | | | 8.93 | 11.02 | 7.25 | 6.62 |
| 12,000,000 | | | | | 9.74 | 12.95 | 7.90 | 7.78 |
| 13,000,000 | | | | | 10.55 | 15.01 | 8.56 | 9.02 |
| 14,000,000 | | | | | | | 9.22 | 10.35 |
| 15,000,000 | | | | | | | 9.88 | 11.76 |
| 16,000,000 | | | | | | | 10.54 | 13.25 |

*The Hazen-Williams flow coefficient C=140 has been used for cement-lined cast iron and ductile iron pipe for many years. The quality of recent high-performance cement lining for ductile iron pipe and the availability of even larger pipe sizes may justify the use of significantly higher values for C, particularly in the intermediate and larger pipe sizes. (See pg 17-4.)

The design of systems outside common water velocities, i.e. 2-5 fps, may involve special design considerations (for example, the generation of substantial surge pressures as a result of valve closure or other water column effects, sedimentation at extremely low velocities, etc.).



Flow of Water in Ductile Iron Pipe Hazen-Williams C=140*

Loss of head shown is per 1,000 feet of pipeline. Table is based on 4"–64" AWWA C104 single-thickness cement-lined ductile iron pipe. Nominal thickness for minimum standard pressure classes noted.

Table No. 17-1—Continued

| Flow in Gallons per 24 Hours | 24" Pipe, Class 200 | | 30" Pipe, Class 150 | | 36" Pipe, Class 150 | | 42" Pipe, Class 150 | |
|------------------------------|----------------------|-------------------|----------------------|-------------------|----------------------|-------------------|----------------------|-------------------|
| | Vel. in ft. per sec. | Loss of Head (ft) | Vel. in ft. per sec. | Loss of Head (ft) | Vel. in ft. per sec. | Loss of Head (ft) | Vel. in ft. per sec. | Loss of Head (ft) |
| 1,000,000 | .46 | .03 | | | | | | |
| 1,200,000 | .55 | .04 | | | | | | |
| 1,400,000 | .64 | .06 | | | | | | |
| 1,500,000 | .68 | .07 | .44 | .02 | .31 | .01 | | |
| 1,600,000 | .73 | .08 | .47 | .03 | .33 | .01 | | |
| 1,800,000 | .82 | .09 | .53 | .03 | .37 | .01 | | |
| 2,000,000 | .91 | .11 | .59 | .04 | .41 | .02 | | |
| 2,500,000 | 1.14 | .17 | .73 | .06 | .51 | .02 | | |
| 3,000,000 | 1.37 | .24 | .88 | .08 | .61 | .03 | .45 | .02 |
| 3,500,000 | 1.59 | .32 | 1.03 | .11 | .71 | .05 | .53 | .02 |
| 4,000,000 | 1.82 | .41 | 1.18 | .14 | .82 | .06 | .60 | .03 |
| 4,500,000 | 2.05 | .52 | 1.32 | .18 | .92 | .07 | .68 | .03 |
| 5,000,000 | 2.28 | .63 | 1.47 | .22 | 1.02 | .09 | .75 | .04 |
| 5,500,000 | 2.51 | .75 | 1.62 | .26 | 1.12 | .11 | .83 | .05 |
| 6,000,000 | 2.73 | .88 | 1.76 | .30 | 1.22 | .12 | .90 | .06 |
| 6,500,000 | 2.96 | 1.02 | 1.91 | .35 | 1.33 | .14 | .98 | .07 |
| 7,000,000 | 3.19 | 1.17 | 2.06 | .40 | 1.43 | .17 | 1.05 | .08 |
| 7,500,000 | 3.42 | 1.33 | 2.20 | .46 | 1.53 | .19 | 1.13 | .09 |
| 8,000,000 | 3.64 | 1.50 | 2.35 | .51 | 1.63 | .21 | 1.20 | .10 |
| 8,500,000 | 3.87 | 1.67 | 2.50 | .58 | 1.73 | .24 | 1.28 | .11 |
| 9,000,000 | 4.10 | 1.86 | 2.64 | .64 | 1.84 | .26 | 1.35 | .13 |
| 9,500,000 | 4.33 | 2.06 | 2.79 | .71 | 1.94 | .29 | 1.43 | .14 |
| 10,000,000 | 4.56 | 2.26 | 2.94 | .78 | 2.04 | .32 | 1.50 | .15 |
| 11,000,000 | 5.01 | 2.70 | 3.23 | .93 | 2.24 | .38 | 1.65 | .18 |
| 12,000,000 | 5.47 | 3.17 | 3.53 | 1.09 | 2.45 | .45 | 1.80 | .21 |
| 13,000,000 | 5.92 | 3.68 | 3.82 | 1.26 | 2.65 | .52 | 1.96 | .25 |
| 14,000,000 | 6.38 | 4.22 | 4.11 | 1.45 | 2.86 | .60 | 2.11 | .28 |
| 15,000,000 | 6.83 | 4.79 | 4.41 | 1.65 | 3.06 | .68 | 2.26 | .32 |
| 16,000,000 | 7.29 | 5.49 | 4.70 | 1.86 | 3.26 | .76 | 2.41 | .36 |
| 18,000,000 | 8.20 | 6.72 | 5.29 | 2.31 | 3.67 | .95 | 2.71 | .45 |
| 20,000,000 | 9.11 | 8.17 | 5.88 | 2.81 | 4.08 | 1.15 | 3.01 | .55 |
| 22,000,000 | 10.02 | 9.74 | 6.46 | 3.35 | 4.49 | 1.38 | 3.31 | .66 |
| 24,000,000 | | | 7.05 | 3.93 | 4.90 | 1.62 | 3.61 | .77 |
| 26,000,000 | | | 7.64 | 4.56 | 5.30 | 1.88 | 3.91 | .89 |
| 28,000,000 | | | 8.23 | 5.23 | 5.71 | 2.15 | 4.21 | 1.02 |
| 30,000,000 | | | 8.82 | 5.95 | 6.12 | 2.45 | 4.51 | 1.16 |
| 32,000,000 | | | 9.40 | 6.70 | 6.53 | 2.76 | 4.81 | 1.31 |
| 34,000,000 | | | 9.99 | 7.50 | 6.94 | 3.08 | 5.11 | 1.47 |
| 36,000,000 | | | 10.58 | 8.34 | 7.34 | 3.43 | 5.41 | 1.63 |
| 38,000,000 | | | | | 7.75 | 3.79 | 5.72 | 1.80 |
| 40,000,000 | | | | | 8.16 | 4.17 | 6.02 | 1.92 |
| 45,000,000 | | | | | 9.18 | 5.18 | 6.77 | 2.47 |
| 50,000,000 | | | | | 10.20 | 6.30 | 7.52 | 3.00 |
| 55,000,000 | | | | | | | 8.27 | 3.58 |
| 60,000,000 | | | | | | | 9.02 | 4.20 |
| 65,000,000 | | | | | | | 9.78 | 4.87 |
| 70,000,000 | | | | | | | 10.53 | 5.59 |

*The Hazen-Williams flow coefficient C=140 has been used for cement-lined cast iron and ductile iron pipe for many years. The quality of recent high-performance cement lining for ductile iron pipe and the availability of even larger pipe sizes may justify the use of significantly higher values for C, particularly in the intermediate and larger pipe sizes. (See pg 17-4.)

The design of systems outside common water velocities, i.e. 2–5 fps, may involve special design considerations (for example, the generation of substantial surge pressures as a result of valve closure or other water column effects, sedimentation at extremely low velocities, etc.)



Flow of Water in Ductile Iron Pipe Hazen-Williams C=140*

Loss of head shown is per 1,000 feet of pipeline. Table is based on 4"-64" AWWA C104 single-thickness cement-lined ductile iron pipe. Nominal thickness for minimum standard pressure classes noted.

Table No. 17-1—Continued

| Flow in Gallons per 24 Hours | 48" Pipe, Class 150 | | 54" Pipe, Class 150 | | 60" Pipe, Class 150 | | 64" Pipe, Class 150 | |
|------------------------------|----------------------|-------------------|----------------------|-------------------|----------------------|-------------------|----------------------|-------------------|
| | Vel. in ft. per sec. | Loss of Head (ft) | Vel. in ft. per sec. | Loss of Head (ft) | Vel. in ft. per sec. | Loss of Head (ft) | Vel. in ft. per sec. | Loss of Head (ft) |
| 3,000,000 | .35 | .01 | | | | | | |
| 4,000,000 | .46 | .01 | | | | | | |
| 5,000,000 | .58 | .02 | | | | | | |
| 6,000,000 | .69 | .03 | .54 | .02 | .47 | .01 | .41 | .01 |
| 7,000,000 | .81 | .04 | .63 | .02 | .55 | .02 | .48 | .01 |
| 8,000,000 | .92 | .05 | .72 | .03 | .62 | .02 | .55 | .01 |
| 9,000,000 | 1.04 | .07 | .81 | .04 | .70 | .03 | .62 | .02 |
| 10,000,000 | 1.15 | .08 | .90 | .04 | .78 | .03 | .69 | .02 |
| 12,000,000 | 1.38 | .11 | 1.07 | .06 | .94 | .04 | .82 | .03 |
| 14,000,000 | 1.61 | .15 | 1.25 | .08 | 1.09 | .06 | .96 | .04 |
| 16,000,000 | 1.84 | .19 | 1.43 | .10 | 1.25 | .07 | 1.10 | .05 |
| 18,000,000 | 2.07 | .24 | 1.61 | .13 | 1.41 | .09 | 1.24 | .07 |
| 20,000,000 | 2.30 | .29 | 1.79 | .16 | 1.56 | .11 | 1.37 | .08 |
| 22,000,000 | 2.53 | .34 | 1.97 | .19 | 1.72 | .13 | 1.51 | .10 |
| 24,000,000 | 2.76 | .40 | 2.15 | .22 | 1.87 | .16 | 1.65 | .11 |
| 26,000,000 | 2.99 | .47 | 2.33 | .25 | 2.03 | .18 | 1.78 | .13 |
| 28,000,000 | 3.22 | .53 | 2.51 | .29 | 2.19 | .21 | 1.92 | .15 |
| 30,000,000 | 3.46 | .61 | 2.69 | .33 | 2.34 | .24 | 2.06 | .17 |
| 32,000,000 | 3.69 | .68 | 2.86 | .37 | 2.50 | .27 | 2.20 | .19 |
| 34,000,000 | 3.92 | .77 | 3.04 | .41 | 2.65 | .30 | 2.33 | .22 |
| 36,000,000 | 4.15 | .85 | 3.22 | .46 | 2.81 | .33 | 2.47 | .24 |
| 38,000,000 | 4.38 | .94 | 3.40 | .51 | 2.97 | .37 | 2.61 | .27 |
| 40,000,000 | 4.61 | 1.04 | 3.58 | .56 | 3.12 | .40 | 2.74 | .29 |
| 45,000,000 | 5.18 | 1.29 | 4.03 | .70 | 3.51 | .50 | 3.09 | .36 |
| 50,000,000 | 5.76 | 1.57 | 4.48 | .85 | 3.90 | .61 | 3.43 | .44 |
| 55,000,000 | 6.33 | 1.87 | 4.92 | 1.01 | 4.29 | .72 | 3.77 | .53 |
| 60,000,000 | 6.91 | 2.19 | 5.37 | 1.19 | 4.68 | .85 | 4.12 | .62 |
| 65,000,000 | 7.49 | 2.54 | 5.82 | 1.38 | 5.07 | .99 | 4.46 | .72 |
| 70,000,000 | 8.06 | 2.92 | 6.27 | 1.58 | 5.46 | 1.13 | 4.80 | .83 |
| 75,000,000 | 8.64 | 3.32 | 6.71 | 1.80 | 5.86 | 1.29 | 5.15 | .94 |
| 80,000,000 | 9.21 | 3.74 | 7.16 | 2.02 | 6.25 | 1.45 | 5.49 | 1.06 |
| 85,000,000 | 9.79 | 4.18 | 7.61 | 2.26 | 6.64 | 1.62 | 5.83 | 1.18 |
| 90,000,000 | 10.37 | 4.65 | 8.06 | 2.52 | 7.03 | 1.80 | 6.18 | 1.32 |
| 95,000,000 | | | 8.51 | 2.78 | 7.42 | 1.99 | 6.52 | 1.46 |
| 100,000,000 | | | 8.95 | 3.06 | 7.81 | 2.19 | 6.86 | 1.60 |
| 105,000,000 | | | 9.40 | 3.35 | 8.20 | 2.40 | 7.20 | 1.75 |
| 110,000,000 | | | 9.85 | 3.65 | 8.59 | 2.61 | 7.55 | 1.91 |
| 115,000,000 | | | 10.30 | 3.96 | 8.98 | 2.84 | 7.89 | 2.07 |
| 120,000,000 | | | | | 9.37 | 3.07 | 8.23 | 2.24 |
| 125,000,000 | | | | | 9.76 | 3.31 | 8.58 | 2.42 |
| 130,000,000 | | | | | 10.15 | 3.56 | 8.92 | 2.60 |
| 135,000,000 | | | | | | | 9.26 | 2.79 |
| 140,000,000 | | | | | | | 9.61 | 2.98 |
| 145,000,000 | | | | | | | 9.95 | 3.18 |
| 150,000,000 | | | | | | | 10.29 | 3.39 |

*The Hazen-Williams flow coefficient C=140 has been used for cement-lined cast iron and ductile iron pipe for many years. The quality of recent high-performance cement lining for ductile iron pipe and the availability of even larger pipe sizes may justify the use of significantly higher values for C, particularly in the intermediate and larger pipe sizes. (See pg 17-4.)

The design of systems outside common water velocities, i.e. 2-5 fps, may involve special design considerations (for example, the generation of substantial surge pressures as a result of valve closure or other water column effects, sedimentation at extremely low velocities, etc.).



Gravity Flow in Pipe Manning Formula

| | Nominal Size | | Nominal I.D. | Thickness Class |
|--|--------------|--|--------------|-----------------|
| FORMULAS: — for pipe flowing full — | 64" | | 64.47" | Class 150 |
| $Q = \frac{0.276}{n} \times D^{8/3} \times S^{1/2}$ | 60" | | 60.45" | Class 150 |
| $V = \frac{0.1125}{n} \times D^{2/3} \times S^{1/2}$ | 54" | | 56.46" | Class 150 |
| Q = Flow in gallons per minute | 48" | | 49.80" | Class 150 |
| D = Pipe diameter in inches | 42" | | 43.60" | Class 150 |
| S = Slope in feet per foot | 36" | | 37.46" | Class 150 |
| V = Velocity in feet per second | 30" | | 31.24" | Class 150 |
| Protecto 401-lined ductile iron pipe has an approximate "n" value of n = 0.011*. | 24" | | 25.06" | Class 200 |
| Example: For a 20" Ductile Iron Protecto 401-lined pipe, Pressure Class 250, with a slope of 4.5 feet per 1000 feet, find the flow "Q" and the velocity "V" when the pipe is flowing full. The roughness coefficient "n" is 0.011. | 20" | | 20.86" | Class 250 |
| $Q = \frac{.276}{0.011} \times (20.86)^{8/3} \times (0.0045)^{1/2}$ | 18" | | 18.80" | Class 250 |
| Q = 5550 gals./min. | 16" | | 16.72" | Class 250 |
| $V = \frac{.1125}{0.011} \times (20.86)^{2/3} \times (0.0045)^{1/2}$ | 14" | | 14.66" | Class 250 |
| V = 5.20 feet/sec. | 12" | | 12.56" | Class 350 |
| | 10" | | 10.50" | Class 350 |
| | 8" | | 8.47" | Class 350 |
| | 6" | | 6.32" | Class 350 |

Note: *Per Protecto 401 website at:
<http://www.protecto401.com/n-cfactor.htm>

Ductile Nominal Minimum Pressure Class
Thickness Protecto 401-Lined Pipe

Fig. 17-1



Equivalent Pipe Diameters

Table No. 17-2

| Nominal Dia. of Pipe "A" | Nominal Dia. of Pipe "B" | | | | | | | | |
|--------------------------|--------------------------|------|------|------|-------|-------|-------|-------|-------|
| | 2 | 3 | 4 | 6 | 8 | 10 | 12 | 14 | 16 |
| 2 | 2.6 | 3.36 | 4.23 | 6.12 | 8.08 | | | | |
| 3 | | 3.90 | 4.63 | 6.35 | 8.23 | 10.16 | | | |
| 4 | | | 5.21 | 6.71 | 8.47 | 10.33 | 12.25 | | |
| 6 | | | | 7.81 | 9.26 | 10.92 | 12.70 | 14.56 | 16.45 |
| 8 | | | | | 10.41 | 11.83 | 13.43 | 15.14 | 16.94 |
| 10 | | | | | | 13.02 | 14.41 | 15.97 | 17.63 |
| 12 | | | | | | | 15.62 | 17.00 | 18.52 |
| 14 | | | | | | | | 18.22 | 19.59 |
| 16 | | | | | | | | | 20.82 |
| 18 | | | | | | | | | |
| 20 | | | | | | | | | |
| 24 | | | | | | | | | |
| 30 | | | | | | | | | |
| 36 | | | | | | | | | |
| 42 | | | | | | | | | |
| 48 | | | | | | | | | |
| 54 | | | | | | | | | |
| 60 | | | | | | | | | |
| 64 | | | | | | | | | |

Table No. 17-2—Continued

| Nominal Dia. of Pipe "A" | Nominal Dia. of Pipe "B" | | | | | | | | | |
|--------------------------|--------------------------|-------|-------|-------|-------|-------|-------|-------|-------|-------|
| | 18 | 20 | 24 | 30 | 36 | 42 | 48 | 54 | 60 | 64 |
| 2 | | | | | | | | | | |
| 3 | | | | | | | | | | |
| 4 | | | | | | | | | | |
| 6 | | | | | | | | | | |
| 8 | 18.78 | 20.66 | 24.50 | 30.35 | 36.26 | | | | | |
| 10 | 19.37 | 21.17 | 24.89 | 30.62 | 36.47 | 42.36 | | | | |
| 12 | 20.14 | 21.84 | 25.41 | 31.00 | 36.75 | 42.59 | 48.47 | 54.39 | 60.33 | 64.30 |
| 14 | 21.09 | 22.68 | 26.06 | 31.48 | 37.11 | 42.87 | 48.71 | 54.58 | 60.49 | 64.44 |
| 16 | 22.19 | 23.66 | 26.86 | 32.07 | 37.57 | 43.23 | 49.00 | 54.83 | 60.70 | 64.63 |
| 18 | 23.43 | 24.79 | 27.78 | 32.76 | 38.11 | 43.67 | 49.35 | 55.12 | 60.95 | 64.86 |
| 20 | | 26.03 | 28.83 | 33.57 | 38.74 | 44.18 | 49.77 | 55.47 | 61.25 | 65.13 |
| 24 | | | 31.24 | 35.49 | 40.29 | 45.43 | 50.81 | 56.35 | 61.99 | 65.80 |
| 30 | | | | 39.05 | 43.24 | 47.90 | 52.89 | 58.12 | 63.52 | 67.19 |
| 36 | | | | | 46.86 | 51.00 | 55.56 | 60.43 | 65.53 | 69.03 |
| 42 | | | | | | 54.67 | 58.78 | 63.26 | 68.03 | 71.34 |
| 48 | | | | | | | 62.47 | 66.57 | 70.98 | 74.08 |
| 54 | | | | | | | | 70.28 | 74.36 | 77.24 |
| 60 | | | | | | | | | 78.09 | 80.76 |
| 64 | | | | | | | | | | 83.30 |

All figures are in inches.

Example: In parallel, a 6-inch and an 8-inch main are only equivalent to one pipe 9.26 inches in diameter.

The equivalent size pipe required to equal, at the same head, the carrying capacity of two smaller pipes is tabulated in this table. This evaluation is based on the comparative nominal diameters raised to the 2.63 power.



Equivalent Number of Pipelines

Tabulated below are the approximate number of pipes of a given size equal in carrying capacity to one pipe of a larger size. At the same velocity of flow the volume delivered by two pipes of different sizes is proportional to the squares of their diameters. With the same head, however, the velocity is less in the smaller pipe, and the volume delivered varies approximately as the diameters to the 2.63 power. This table is calculated on this basis using nominal diameters. The figure opposite the intersection of any two sizes is the number of the smaller-sized pipes required to equal one of the larger; thus one 4-inch pipe equals 6.2 two-inch pipes.

Table No. 17-3

| Dia in. | 1/2 | 3/4 | 1 | 2 | 3 | 4 | 5 | 6 | 7 | 8 | 10 | 12 |
|---------|-------|-------|-------|-------|-------|-------|-------|-------|------|------|------|------|
| 2 | 38.3 | 13.2 | 6.2 | 1.0 | | | | | | | | |
| 3 | 111.3 | 38.3 | 18.0 | 2.9 | 1.0 | | | | | | | |
| 4 | 237.2 | 81.7 | 38.3 | 6.2 | 2.1 | 1.0 | | | | | | |
| 6 | 689.0 | 237.2 | 111.3 | 18.0 | 6.2 | 2.9 | 1.6 | 1.0 | | | | |
| 8 | | 505.5 | 237.2 | 38.3 | 13.2 | 6.2 | 3.4 | 2.1 | 1.4 | 1.0 | | |
| 10 | | 909.1 | 426.6 | 68.9 | 23.7 | 11.1 | 6.2 | 3.8 | 2.6 | 1.8 | 1.0 | |
| 12 | | | 689.0 | 111.3 | 38.3 | 18.0 | 10.0 | 6.2 | 4.1 | 2.9 | 1.6 | 1.0 |
| 14 | | | | 167.0 | 57.5 | 27.0 | 15.0 | 9.3 | 6.2 | 4.3 | 2.4 | 1.5 |
| 16 | | | | 237.2 | 81.7 | 38.3 | 21.3 | 13.2 | 8.8 | 6.2 | 3.4 | 2.1 |
| 18 | | | | 323.3 | 111.3 | 52.2 | 29.0 | 18.0 | 12.0 | 8.4 | 4.7 | 2.9 |
| 20 | | | | 426.6 | 146.9 | 68.9 | 38.3 | 23.7 | 15.8 | 11.1 | 6.2 | 3.8 |
| 24 | | | | 689.0 | 237.2 | 111.3 | 61.9 | 38.3 | 25.5 | 18.0 | 10.0 | 6.2 |
| 30 | | | | | | 200.2 | 111.3 | 68.9 | 45.9 | 32.3 | 18.0 | 11.1 |
| 36 | | | | | | | | 111.3 | 74.2 | 52.2 | 29.1 | 18.0 |
| 42 | | | | | | | | | 74.2 | 78.3 | 43.6 | 27.0 |
| 48 | | | | | | | | | | | 61.9 | 38.3 |
| 54 | | | | | | | | | | | | 52.2 |
| 60 | | | | | | | | | | | | 68.9 |
| 64 | | | | | | | | | | | | 81.7 |

Table No. 17-3—Continued

| Dia in. | 14 | 16 | 18 | 20 | 24 | 30 | 36 | 42 | 48 | 54 | 60 | 64 |
|---------|------|------|------|------|------|-----|-----|-----|-----|-----|-----|-----|
| 2 | | | | | | | | | | | | |
| 3 | | | | | | | | | | | | |
| 4 | | | | | | | | | | | | |
| 6 | | | | | | | | | | | | |
| 8 | | | | | | | | | | | | |
| 10 | | | | | | | | | | | | |
| 12 | | | | | | | | | | | | |
| 14 | 1.0 | | | | | | | | | | | |
| 16 | 1.4 | 1.0 | | | | | | | | | | |
| 18 | 1.9 | 1.4 | 1.0 | | | | | | | | | |
| 20 | 2.6 | 1.8 | 1.3 | 1.0 | | | | | | | | |
| 24 | 4.1 | 2.9 | 2.1 | 1.6 | 1.0 | | | | | | | |
| 30 | 7.4 | 5.2 | 3.8 | 2.9 | 1.8 | 1.0 | | | | | | |
| 36 | 12.0 | 8.4 | 6.2 | 4.7 | 2.9 | 1.6 | 1.0 | | | | | |
| 42 | 18.0 | 12.7 | 9.3 | 7.0 | 4.4 | 2.4 | 1.5 | 1.0 | | | | |
| 48 | 25.5 | 18.0 | 13.2 | 10.0 | 6.2 | 3.4 | 2.1 | 1.4 | 1.0 | | | |
| 54 | 34.8 | 24.5 | 18.0 | 13.6 | 8.4 | 4.7 | 2.9 | 1.9 | 1.4 | 1.0 | | |
| 60 | 45.9 | 32.3 | 23.7 | 18.0 | 11.1 | 6.2 | 3.8 | 2.6 | 1.8 | 1.3 | 1.0 | |
| 64 | 54.4 | 38.3 | 28.1 | 21.3 | 13.2 | 7.3 | 4.5 | 3.0 | 2.1 | 1.6 | 1.2 | 1.0 |



Diameters, Circumferences, Areas and Volumes for Standard Minimum Pressure Classes of Ductile Iron Single-Thickness Cement-Lined Pipe

Table No. 17-4

| Nominal Size in. | Outside Diameter in. | Inside Diameter in. | Cross Sectional Areas | | O.D. Circumference in. | I.D. Circumference in. | Approx. Outside Surface Area* sq. ft. | Volume Gallons per linear ft. | Volume† Gallons per 20' nom. length |
|------------------|----------------------|---------------------|-----------------------|-----------------------|------------------------|------------------------|---------------------------------------|-------------------------------|-------------------------------------|
| | | | Based on O.D. sq. in. | Based on I.D. sq. in. | | | | | |
| 4 | 4.80 | 4.17 | 18.10 | 13.66 | 15.08 | 13.10 | 26 | 0.71 | 14.19 |
| 6 | 6.90 | 6.27 | 37.39 | 30.88 | 21.68 | 19.70 | 37 | 1.60 | 32.08 |
| 8 | 9.05 | 8.42 | 64.33 | 55.68 | 28.43 | 26.45 | 48 | 2.89 | 57.85 |
| 10 | 11.10 | 10.45 | 96.77 | 85.77 | 34.87 | 32.83 | 59 | 4.46 | 89.11 |
| 12 | 13.20 | 12.51 | 136.85 | 122.92 | 41.47 | 39.30 | 70 | 6.39 | 127.71 |
| 14 | 15.30 | 14.55 | 183.85 | 166.27 | 48.07 | 45.71 | 82 | 8.64 | 172.75 |
| 16 | 17.40 | 16.61 | 237.79 | 216.69 | 54.66 | 52.18 | 93 | 11.26 | 225.13 |
| 18 | 19.50 | 18.69 | 298.65 | 274.35 | 61.26 | 58.72 | 105 | 14.25 | 285.04 |
| 20 | 21.60 | 20.75 | 366.44 | 338.16 | 67.86 | 65.19 | 116 | 17.57 | 351.34 |
| 24 | 25.80 | 24.95 | 522.79 | 488.91 | 81.05 | 78.38 | 138 | 25.40 | 507.96 |
| 30 | 32.00 | 31.07 | 804.25 | 758.18 | 100.83 | 97.61 | 172 | 39.39 | 787.72 |
| 36 | 38.30 | 37.29 | 1152.10 | 1092.13 | 120.32 | 117.15 | 206 | 56.73 | 1134.68 |
| 42 | 44.50 | 43.43 | 1555.29 | 1481.39 | 139.80 | 136.44 | 240 | 76.96 | 1539.11 |
| 48 | 50.80 | 49.63 | 2026.83 | 1934.55 | 159.59 | 155.92 | 275 | 100.50 | 2009.92 |
| 54 | 57.56 | 56.29 | 2602.15 | 2488.59 | 180.83 | 176.84 | 312 | 129.28 | 2585.55 |
| 60 | 61.61 | 60.28 | 2981.22 | 2853.89 | 193.55 | 189.37 | 334 | 148.25 | 2965.08 |
| 64 | 65.67 | 64.30 | 3387.08 | 3247.23 | 206.31 | 202.00 | 357 | 168.69 | 3373.75 |

*This value is roughly calculated as the outside surface area of a cylinder with an O.D. equal to the standard barrel O.D. of the pipe and length equal to the overall length of a "full-length" Fastite® pipe. Obviously, cut or trim pipe would have less surface area. Also, if one wanted to include the flare effects on area as a result of the sloping bell contour or the area of the radial bell face, this would increase the areas very slightly from the tabular values shown.

†This value may also be helpful in a rough determination of the "buoyancy" of a ductile iron pipe full of air. (Buoyancy force is roughly equivalent to weight of fresh or salt water, etc., displaced.) See also Section 9 for buoyancy of 4"-36" Flex-Ring pc 350 pipe.

Weights for Pipeline Design, Weights of Ductile Iron Pipe and Contained Water

Table No. 17-5

| Size in. | Weight - Pounds per Foot | | | Size in. | Weight - Pounds per Foot | | |
|----------|--------------------------|-------|-------|----------|--------------------------|-------|-------|
| | Pipe | Water | Total | | Pipe | Water | Total |
| 4 | 12 | 6 | 18 | 24 | 93 | 212 | 305 |
| 6 | 18 | 13 | 31 | 30 | 123 | 329 | 452 |
| 8 | 24 | 24 | 48 | 36 | 163 | 473 | 636 |
| 10 | 30 | 37 | 67 | 42 | 206 | 642 | 848 |
| 12 | 39 | 53 | 92 | 48 | 261 | 838 | 1099 |
| 14 | 47 | 72 | 119 | 54 | 325 | 1078 | 1403 |
| 16 | 57 | 94 | 151 | 60 | 371 | 1237 | 1608 |
| 18 | 66 | 119 | 185 | 64 | 410 | 1407 | 1817 |
| 20 | 78 | 147 | 225 | | | | |

These weights are based on minimum pressure classes Ductile Iron Fastite® pipe with minimum thickness standard cement lining as specified in AWWA C104 and on weight of water of 62.4 pounds per cubic foot. All weights are as "in air" at sea level with no buoyancy effects considered. The inside diameters are given in Table No. 17-4.

Pounds of water per foot = 0.3403 x (I.D. in inches)².
Ductile Iron = 0.255 pounds per cubic inch.



**Axial Bulkhead or Dead-End Thrust
Due to Pressure ***

Table No. 17-6

| Nominal Pipe Size in. | Pipe O.D. For Pressure Area Calc. in. | Pressure (psi) | | | | | | | | | | | | | | |
|--------------------------|---|----------------|--------|---------|---------|---------|---------|---------|---------|-----------|-----------|-----------|-----------|-----------|-----------|-----------|
| | | 0 | 15 | 50 | 100 | 150 | 200 | 225 | 250 | 300 | 350 | 375 | 400 | 450 | 500 | 525 |
| 4 | 4.80 | 0 | 300 | 900 | 1,800 | 2,700 | 3,600 | 4,100 | 4,500 | 5,400 | 6,300 | 6,800 | 7,200 | 8,100 | 9,000 | 9,500 |
| 6 | 6.90 | 0 | 600 | 1,900 | 3,700 | 5,600 | 7,500 | 8,400 | 9,300 | 11,200 | 13,100 | 14,000 | 15,000 | 16,800 | 18,700 | 19,600 |
| 8 | 9.05 | 0 | 1,000 | 3,200 | 6,400 | 9,600 | 12,900 | 14,500 | 16,100 | 19,300 | 22,500 | 24,100 | 25,700 | 28,900 | 32,200 | 33,800 |
| 10 | 11.10 | 0 | 1,500 | 4,800 | 9,700 | 14,500 | 19,400 | 21,800 | 24,200 | 29,000 | 33,900 | 36,300 | 38,700 | 43,500 | 48,400 | 50,800 |
| 12 | 13.20 | 0 | 2,100 | 6,800 | 13,700 | 20,500 | 27,400 | 30,800 | 34,200 | 41,100 | 47,900 | 51,300 | 54,700 | 61,600 | 68,400 | 71,800 |
| 14 | 15.30 | 0 | 2,800 | 9,200 | 18,400 | 27,600 | 36,800 | 41,400 | 46,000 | 55,200 | 64,300 | 68,900 | 73,500 | 82,700 | 91,900 | 96,500 |
| 16 | 17.40 | 0 | 3,600 | 11,900 | 23,800 | 35,700 | 47,600 | 53,500 | 59,400 | 71,300 | 83,200 | 89,200 | 95,100 | 107,000 | 118,900 | 124,800 |
| 18 | 19.50 | 0 | 4,500 | 14,900 | 29,900 | 44,800 | 59,700 | 67,200 | 74,700 | 89,600 | 104,500 | 112,000 | 119,500 | 134,400 | 149,300 | 156,800 |
| 20 | 21.60 | 0 | 5,500 | 18,300 | 36,600 | 55,000 | 73,300 | 82,400 | 91,600 | 109,900 | 128,200 | 137,400 | 146,600 | 164,900 | 183,200 | 192,400 |
| 24 | 25.80 | 0 | 7,800 | 26,100 | 52,300 | 78,400 | 104,600 | 117,600 | 130,700 | 156,800 | 183,000 | 196,000 | 209,100 | 235,200 | 261,400 | 274,500 |
| 30 | 32.00 | 0 | 12,100 | 40,200 | 80,400 | 120,600 | 160,800 | 181,000 | 201,100 | 241,300 | 281,500 | 301,600 | 321,700 | 361,900 | 402,100 | 422,200 |
| 36 | 38.30 | 0 | 17,300 | 57,600 | 115,200 | 172,800 | 230,400 | 259,200 | 288,000 | 345,600 | 403,200 | 432,000 | 460,800 | 518,400 | 576,000 | 604,800 |
| 42 | 44.50 | 0 | 23,300 | 77,800 | 155,500 | 233,300 | 311,000 | 349,900 | 388,800 | 466,600 | 544,300 | 583,200 | 622,100 | 699,900 | 777,600 | 816,500 |
| 48 | 50.80 | 0 | 30,400 | 101,300 | 202,700 | 304,000 | 405,400 | 456,000 | 506,700 | 608,000 | 709,400 | 760,000 | 810,700 | 912,000 | 1,013,400 | 1,064,100 |
| 54 | 57.56 | 0 | 39,000 | 130,100 | 260,200 | 390,300 | 520,400 | 585,500 | 650,500 | 780,600 | 910,700 | 975,800 | 1,040,800 | 1,170,900 | 1,301,000 | 1,366,100 |
| 60 | 61.61 | 0 | 44,700 | 149,100 | 298,100 | 447,200 | 596,200 | 670,800 | 745,300 | 894,300 | 1,043,400 | 1,117,900 | 1,192,400 | 1,341,500 | 1,490,600 | 1,565,100 |
| 64 | 65.67 | 0 | 50,800 | 169,300 | 338,700 | 508,000 | 677,400 | 762,100 | 846,700 | 1,016,100 | 1,185,400 | 1,270,100 | 1,354,800 | 1,524,100 | 1,693,500 | 1,778,200 |

*This value represents the force in pounds that will be exerted on a test bulkhead (plug, cap, blind flange, etc.), a closed valve (disk, gate, ball, wedge, cone, etc.), or the back of a full-opening tee by the aggregate effect of internal pressure acting over the pressure area (PA). The tabular numbers do not include any provision for safety factors nor momentum effects such as surge pressures in line filling or operation over the pressure values shown. The manual "Thrust Restraint Design for Ductile Iron Pipe" contains a more comprehensive discussion on the subjects of thrust forces and thrust restraint.



Standard Abbreviations and Acronyms

Listed below are many of the standard abbreviations AMERICAN uses on quotations, line drawings, sales order contracts, shipping lists and invoices.

Table No. 17-7

| Product or Term Identification or Description | Standard Abbreviation |
|---|-------------------------|
| A. | |
| Accessories..... | ACC |
| Adjustment..... | ADJ |
| Air Test..... | A/T |
| Allocated..... | ALLOC |
| Alloy..... | ALLOY |
| Alloy Steel Bolts THHN..... | BOLT THHN |
| All Mechanical Joint Tee..... | MJ TEE |
| American Cast Iron Pipe Company..... | ACIPCO |
| American-Darling Valve..... | ADV |
| American Ductile Iron Pipe Division..... | ADIP |
| American Fastite Pipe, Ductile Iron..... | FST PIPE |
| American Flex-Lok Ball & Socket Pipe, Ductile Iron..... | FLEXLOK PIPE (or FLXLK) |
| American Flow Control Division..... | AFC |
| Armor TIP (MJ)..... | MJARMT |
| Asphaltic Coated Inside & Outside..... | CTD |
| Asphaltic Coated Outside & Cement Lined Inside..... | C/L |
| Asphaltic Coated Outside & Double Thickness Cement Lined Inside..... | DBL C/L |
| Assembled..... | ASSEMB |
| Assigned Not Shipped..... | ANS |
| As Soon As Possible..... | ASAP |
| Atlanta District Office..... | ATL |
| B. | |
| Back Face..... | BF |
| Ball End..... | BALL |
| Base Faced & Drilled..... | BA F&D |
| Base Drilled..... | BA DR |
| Base (Tee or Bend)..... | BASE |
| Bell Gland..... | BG |
| Bell Joint Clamp..... | BELL JT CLAMP |
| Bell Joint Clamp Gasket..... | BELL JT CLAMP GSK |
| Bell & Spigot..... | BS (Designate GA) |
| Bend..... | BEND |
| Beveled..... | BEV |
| Bill of Lading..... | B/L |
| Bill of Material..... | BOM |
| Birmingham District Office..... | BHM |
| Blind..... | BLD |
| Blind Flange..... | BLD FLG |
| Blind Flange Tap 1" (NPT or IPS) at Invert..... | BLD FLG TAP 1 INV |
| Blind Flange Tap 1" in Center..... | BLD FLG TAP 1 |
| Blue Print..... | B/P |



Standard Abbreviations and Acronyms

Table No. 17-7 - Continued

| Product or Term Identification or Description | Standard Abbreviation |
|---|-----------------------|
| Bolt Circle | B/C |
| Both Flanges Hand Tight | BOTH FHT |
| Bolt Holes..... | BH |
| Bolts, Alloy Steel THHN..... | BOLT THHN |
| Boss & Tap..... | B&T |
| Branch..... | BR |
| Bronze..... | BRZ |
| C. | |
| Cement Lined..... | C/L |
| Center..... | CTR |
| Centerline..... | CTR/L |
| Center to End and/or Center to Flare..... | CE |
| Center to Face..... | CF |
| Center to Face-Center to PE..... | CFPE |
| Center to Face-Center to SKT..... | CFS |
| Center to SKT-Center to Face..... | CSF |
| Certificate..... | CERT |
| Chaplets..... | CHAP |
| Change Sheet..... | CS |
| Chicago District Office..... | CHI |
| Class..... | CL |
| Clockwise..... | CW |
| Coal Tar Epoxy..... | CTE___MILS |
| Coated..... | CTD |
| Combination..... | COMB |
| Common..... | COM |
| Compact..... | CMPT |
| Companion Flange..... | COMP FLG |
| Compression Resilient Seated..... | CRS |
| Concentric Reducer..... | RED |
| Conductive Jumper Strip..... | COND JUMPER |
| Copper Clip..... | CC |
| Counter Clockwise..... | CCW |
| Coupling..... | CPLG |
| Coupling Gland End..... | CGE |
| Cross..... | CROSS |
| Customer..... | CUST |
| Cut to Suit in Field..... | CTSIF |
| Cylinder..... | CYL |
| D. | |
| Dallas District Office..... | DAL |
| Delivery..... | DEL |
| Department..... | DEPT |
| Description..... | DESC |
| Destination..... | DEST |
| Diameter..... | DIA |



Standard Abbreviations and Acronyms

Table No. 17-7 - Continued

| Product or Term Identification or Description | Standard Abbreviation |
|--|-------------------------|
| Difference..... | DIFF |
| Double..... | DBL |
| Double Cement Lined..... | DCL |
| Drill..... | DR |
| Duck Back Duck Tip..... | DT |
| Ductile Iron..... | DI |
| Ductile Iron Centrifugally Cast Pipe or Pipe Fabricated from Centrifugally Cast Pipe..... | PIPE |
| Ductile Iron Pipe..... | DIP |
| Ductile Iron Pipe Research Association..... | DIPRA |
| E. | |
| Each..... | EA |
| Eccentric..... | ECC |
| Eccentric Reducer..... | ECC RED |
| Electric..... | ELECT |
| Extension..... | EXT |
| F. | |
| Face & Drill..... | F&D |
| Face & Tap..... | F&T |
| Fast-Grip..... | FAST-GRIP |
| Fastite Conductive Gasket..... | FST PRCE GSK |
| Fastite Extra Deflection Socket..... | FST XDF |
| Fastite Joint Clamp..... | FST JT CLAMP |
| Fastite Lubricant..... | FST LUBE |
| Fastite Neoprene Gasket..... | FST NP GSK |
| Fastite Pipe..... | FST PIPE |
| Fastite Plain Rubber Gasket..... | FST GSK |
| Fastite Socket..... | FST |
| Feet..... | FT |
| Field Flex-Ring..... | FFR |
| Fitting..... | FTG |
| Flange(d)..... | FLG or F |
| Flange Back Outlet..... | FLG BACK OUTLET |
| Flange Filler..... | FLG FILLER |
| Flange Flange Flange Casting, Ductile (Statically Cast)..... | FFF WALL CASTING DI |
| Flange Flange Flange Tee..... | FLG TEE |
| Flange-Thrust Collar-Flange Wall Pipe, Ductile screwed-on Flanges, Welded-on Thrust Collar, Thrust Collar Centered... | F-TC-F WALL PIPE |
| Flange Flange Pipe, Ductile Iron (Fabricated)..... | FF PIPE |
| Flange Flange Pipe, Ductile Iron (Statically Cast)..... | FF SPOOL DI |
| Flange Flange 90 Bend..... | FLG 90 BEND |
| Flange Hand Tight..... | FHT or FLG-HT |
| Flange Heel Outlet..... | FHO |
| Flange & Plain End Pipe, Ductile Iron (Fabricated)..... | FPE PIPE (Designate GA) |
| Flange Side Outlet..... | FSO |
| Flare..... | FLARE |
| Flexible..... | FLEX |
| Flexible Grooved End..... | VEG (F) |
| Flex-Lok Ball..... | FLXBALL |
| Flex-Lok Pipe..... | FLEXLOK PIPE (or FLXLK) |



Standard Abbreviations and Acronyms

Table No. 17-7 - Continued

| Product or Term Identification or Description | Standard Abbreviation |
|--|------------------------|
| Flex-Lok Socket..... | FLXSKT |
| Flex-Ring..... | FR or XR |
| Flex-Ring End..... | FRE or XRE |
| Fluoroelastomer (Fluorel, Viton)*..... | FKM |
| For your information..... | FYI |
| Freight..... | FRT |
| Full Length..... | FL |
| 12x10 Flange 90 Reducing Base Bend | |
| Base Opposite 12" Flange..... | 12x10 FLG 90 BASE BEND |
| | 12 CF 250 LEUP |
| G. | |
| Galvanized..... | GALV |
| Gasket..... | GSK |
| Gauge Caulk Joint..... | GACJ |
| Gauge Dresser (____OD)..... | GADR____OD |
| Gauge Fastite..... | GAFST |
| Gauge Full Length..... | GAFL |
| Gauge MJ..... | GAMJ |
| Gland..... | GLD |
| Gravity Microtunneling..... | GMT |
| Gravity Microtunneling End..... | GMTE |
| Gray Cast Iron..... | GI |
| Grooved End, Grooved End Pipe, Ductile Iron..... | VGE VGE PIPE (R or F) |
| H. | |
| Hex Head Bolt Black Machine..... | HHHN BL MACH |
| Hex Head Hex Nut..... | HHHN |
| Hole..... | H (HOLE) |
| Hydrant..... | HYD |
| Hydrostatic Test..... | HYDRO/T |
| I. | |
| Inside Diameter..... | ID |
| Invert..... | INV |
| Iron Body Bronze Mounted..... | IBBM |
| J. | |
| Joint Material..... | JT MTL |
| K. | |
| Kansas City District Office..... | KC |
| L. | |
| Large End..... | LE |
| Laying Length..... | LL |
| Length..... | LGT |
| Less Than Truckload..... | LTL |
| Lever and Spring..... | L&S |
| Lever and Weight..... | L&W |
| Lining, Coating, Testing..... | LCT |

*These are "brand" or "trade" names. Abbreviation is the acronym for the generic designation.



Standard Abbreviations and Acronyms

Table No. 17-7 - Continued

| Product or Term Identification or Description | Standard Abbreviation |
|---|-----------------------|
| Lok-Ring Bell..... | LKR |
| Lok-Ring End..... | LKRE |
| Lok-Ring Pipe (Cut Pipe)..... | LKR LKRE PIPE |
| Lok-Ring Pipe (Full Length)..... | LKR PIPE |
| Long Pattern..... | LG PAT |
| Long Radius..... | LR |
| Lubricant..... | LUBE |
| Pound..... | LB |
| M. | |
| Manufacture..... | MFG |
| Maximum..... | MAX |
| Mechanical Joint..... | MJ |
| Mechanical Joint Coupled Joint End..... | MJCJE |
| Mechanical Joint Tee..... | MJ TEE |
| Microtunneling..... | MT |
| Millimeter..... | MM |
| Minimum..... | MIN |
| Minneapolis District Office..... | MPLS |
| MJ & Plain End, Ductile (Cut Pipe)..... | MJPE PIPE |
| MJ & Plain End, Ductile (Full Length)..... | MJ PIPE |
| MJ Armor Tip..... | MJARMT |
| MJ Fabricated Bell..... | MJ-FAB |
| MJ MJ 90 Bend..... | MJ 90 BEND |
| Monoloy..... | MON |
| Scrap Metal Index..... | M/I |
| N. | |
| Neoprene..... | NP |
| Nitrile-Butadiene (Hycar, Buna-N, Crynac, Chemigum)*..... | NBR |
| No Sealcoat..... | NSC |
| Nominal..... | NOM |
| Non Rising Stem..... | NRS |
| Not Coated..... | NOT CTD |
| O. | |
| On Hand..... | OH |
| One Flange Hand Tight..... | 1FHT |
| Operator..... | OPER |
| Original Order..... | ORIG ORDER |
| Orlando District Office..... | ORL |
| Outside Diameter..... | OD |
| Outside Screw and Yoke..... | OS & Y |
| Overall Length..... | OA |

*These are "brand" or "trade" names. Abbreviation is the acronym for the generic designation.



Standard Abbreviations and Acronyms

Table No. 17-7 - Continued

| Product or Term Identification or Description | Standard Abbreviation |
|---|-----------------------|
| P. | |
| Pittsburgh District Office..... | PITT |
| Plain End Gauge Dresser..... | DRPE |
| Plain End Gauge Fastite..... | FSTPE |
| Plain End Gauge Fastite & Dresser..... | FTDRPE |
| Plain End Gauge MJ..... | MJPE |
| Plain End No Gauge..... | PE |
| Plain End Gauge Push-On..... | POPE |
| Plain Rubber..... | PR |
| Position..... | POS |
| Pound..... | LB |
| Projected On Hand..... | POH |
| Purchase Order/Push-On Socket..... | PO |
| Push-On Joint..... | POJ |
| Q. | |
| Quantity..... | QTY |
| R. | |
| Required..... | REQD |
| Retainer..... | RET |
| Retainer Gland..... | RET GLD |
| Rigid Grooved End..... | VGE (R) |
| Concentric Reducer..... | RED |
| S. | |
| Sacramento District Office..... | SAC |
| Scrap Metal Index..... | M/I |
| Service..... | SRVC |
| Shipping List..... | S/L |
| Sleeve..... | SLV |
| Small End..... | SE |
| Socket..... | SKT |
| Solid Sleeve..... | SLV |
| Special..... | SPL |
| Spigots..... | SPGT |
| Split Sleeve..... | SPLIT SLV |
| Split Tapping Sleeve..... | SPLIT TAP SLV |
| Statically Cast Flange Flange Pipe..... | SPOOL |
| Statically Cast Wall Pipe..... | WALL CASTING |
| Studs..... | STUDS |
| Style..... | ST |
| Victaulic Shoulder End..... | VSE |
| T. | |
| Tap..... | TAP |
| Tap 1" Mueller..... | TAP 1 MUELLER |
| Tap 1" NPT..... | TAP 1 |
| Tap ___ At Position ____..... | TAP ___ POS ____ |
| Tap For Studs..... | TFS |



Standard Abbreviations and Acronyms

Table No. 17-7 - Continued

| Product or Term Identification or Description | Standard Abbreviation |
|---|-----------------------|
| Tapping Saddle Gasket..... | TAP SADDLE GSK |
| Tee..... | TEE |
| Tee-Head Hex Nut..... | THHN |
| Temporary End Fabrication..... | TEFAB |
| Test Certificates..... | TEST CERT |
| Thick..... | THK |
| Threaded..... | THRD |
| Thrust Collar..... | TC |
| Top Dead Center..... | TDC |
| Transition Sleeve..... | TRAN SLV |
| Truck..... | TRK |
| U. | |
| Uncoated..... | NOT CTD |
| Underwater Lubricant..... | U/W LUBE |
| V. | |
| Grooved End & Grooved End Pipe..... | VGE PIPE |
| Victaulic..... | VICT |
| Victaulic Grooved End (Flexible or Rigid)..... | VGE (F) or (R) |
| Victaulic Shoulder End Style ___(41 or 44)..... | VSE ST ___ |
| W. | |
| Statically Cast Wall Pipe..... | Wall Casting |
| Wall Collar..... | W/C |
| Wall Collar (Not in Center)..... | W/C ___From___ |
| Wye..... | WYE |
| X. | |
| Y. | |
| Z. | |



Taps in Ductile Iron Pipe*

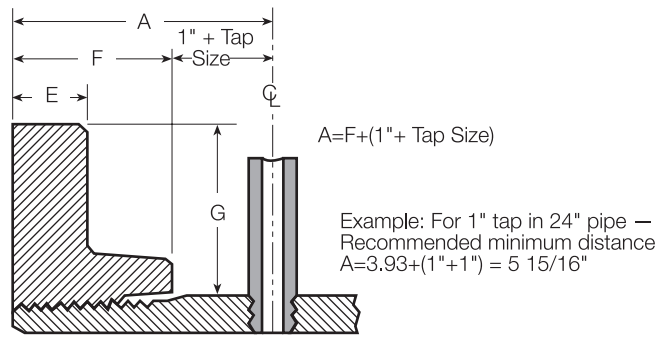

Recommended Minimum Distance — for Small-Diameter Tap — From Face of Pipe Flange to Centerline of Tap

Table No. 17-8

| Parent Pipe Size in. | Dimensions in Inches | | | Parent Pipe Size in. | Dimensions in Inches | | |
|----------------------|----------------------|------|------|----------------------|----------------------|------|------|
| | E | F | G | | E | F | G |
| 4 | .94 | 1.88 | 2.10 | 24 | 1.88 | 3.93 | 3.10 |
| 6 | 1.00 | 2.06 | 2.05 | 30 | 2.12 | 4.50 | 3.38 |
| 8 | 1.12 | 2.25 | 2.23 | 36 | 2.38 | 5.12 | 3.85 |
| 10 | 1.19 | 2.44 | 2.45 | 42 | 2.62 | 5.75 | 4.25 |
| 12 | 1.25 | 2.68 | 2.90 | 48 | 2.75 | 6.38 | 4.35 |
| 14 | 1.38 | 2.87 | 2.85 | 54 | 3.00 | 7.00 | 4.58 |
| 16 | 1.44 | 3.06 | 3.05 | 60 | 3.12 | 7.38 | 5.70 |
| 18 | 1.56 | 3.31 | 2.75 | 64 | 3.38 | 7.38 | 7.17 |
| 20 | 1.69 | 3.50 | 2.95 | | | | |

* While this table provides specific rules governing the placement of individual taps relative to threaded companion flanges on flanged pipe, designers must also respect the positioning of taps relative to other pipe features (bells, wall collars, welded-on thrust collars, other taps, welded-on outlets, etc.). Contact AMERICAN for detailed information if necessary for specific applications.

Figures are based on AWWA C115 Flanges.

If closer tolerance needed, submit details of layout for recommendations.

Standard Pipe Taps—Outside Diameters

Table No. 17-9

| Pipe Tap Size in. | Actual Outside Diameter in. | Pipe Tap Size in. | Actual Outside Diameter in. | Pipe Tap Size in. | Actual Outside Diameter in. |
|-------------------|-----------------------------|-------------------|-----------------------------|-------------------|-----------------------------|
| 1/4 | .540 | 1 | 1.315 | 2 1/2 | 2.875 |
| 3/8 | .675 | 1 1/4 | 1.660 | 3 | 3.500 |
| 1/2 | .840 | 1 1/2 | 1.900 | — | — |
| 3/4 | 1.050 | 2 | 2.375 | — | — |

Above data is based on direct tap into wall of pipe; see Table Nos. 17-10 and 17-11.



Taps in Ductile Iron Pipe ANSI/ASME B1.20.1

Thickness that will affect two, three and four full threads for different size taps with ANSI/ASME B1.20.1 Standard Taper Pipe Threads.

Table No. 17-10

| Pipe Size in. | No. of Threads | Tap Size - in. | | | | | | | | | |
|---------------|----------------|----------------------|-----|-----|-------|-------|-----|-------|-----|-------|-----|
| | | 1/2 | 3/4 | 1 | 1 1/4 | 1 1/2 | 2 | 2 1/2 | 3 | 3 1/2 | 4 |
| | | Pipe Thickness - in. | | | | | | | | | |
| 3 | 2 | .18 | .21 | .28 | | | | | | | |
| 3 | 3 | .26 | .29 | .37 | | | | | | | |
| 3 | 4 | .33 | .36 | .46 | | | | | | | |
| 4 | 2 | .17 | .19 | .26 | .31 | | | | | | |
| 4 | 3 | .25 | .27 | .35 | .40 | | | | | | |
| 4 | 4 | .32 | .34 | .44 | .49 | | | | | | |
| 6 | 2 | .17 | .18 | .23 | .27 | .30 | | | | | |
| 6 | 3 | .25 | .26 | .32 | .36 | .39 | | | | | |
| 6 | 4 | .32 | .33 | .41 | .45 | .48 | | | | | |
| 8 | 2 | .16 | .17 | .22 | .24 | .27 | .33 | | | | |
| 8 | 3 | .24 | .25 | .31 | .33 | .36 | .42 | | | | |
| 8 | 4 | .31 | .32 | .40 | .42 | .45 | .51 | | | | |
| 10 | 2 | .15 | .17 | .21 | .23 | .25 | .30 | .44 | | | |
| 10 | 3 | .23 | .25 | .30 | .32 | .34 | .39 | .56 | | | |
| 10 | 4 | .30 | .32 | .39 | .41 | .43 | .48 | .69 | | | |
| 12 | 2 | .15 | .16 | .20 | .22 | .24 | .28 | .40 | .48 | | |
| 12 | 3 | .23 | .24 | .29 | .31 | .33 | .37 | .52 | .60 | | |
| 12 | 4 | .30 | .31 | .38 | .40 | .42 | .46 | .65 | .73 | | |
| 14 | 2 | .15 | .16 | .20 | .22 | .23 | .26 | .38 | .45 | .51 | .58 |
| 14 | 3 | .23 | .24 | .29 | .31 | .32 | .35 | .50 | .58 | .64 | .70 |
| 14 | 4 | .30 | .31 | .38 | .40 | .41 | .44 | .63 | .70 | .76 | .83 |
| 16 | 2 | .15 | .16 | .20 | .21 | .22 | .25 | .37 | .43 | .48 | .54 |
| 16 | 3 | .23 | .24 | .29 | .30 | .31 | .34 | .50 | .56 | .60 | .66 |
| 16 | 4 | .30 | .31 | .38 | .39 | .40 | .43 | .62 | .68 | .73 | .79 |
| 18 | 2 | .15 | .15 | .19 | .21 | .22 | .24 | .35 | .41 | .46 | .51 |
| 18 | 3 | .23 | .23 | .28 | .30 | .31 | .33 | .48 | .54 | .58 | .64 |
| 18 | 4 | .30 | .30 | .37 | .39 | .40 | .42 | .60 | .66 | .71 | .76 |
| 20 | 2 | .15 | .15 | .19 | .20 | .21 | .23 | .34 | .39 | .44 | .49 |
| 20 | 3 | .23 | .23 | .28 | .29 | .30 | .32 | .46 | .52 | .56 | .62 |
| 20 | 4 | .30 | .30 | .37 | .38 | .39 | .41 | .59 | .64 | .69 | .74 |
| 24 | 2 | .14 | .15 | .19 | .20 | .21 | .22 | .32 | .37 | .40 | .45 |
| 24 | 3 | .22 | .23 | .28 | .29 | .30 | .31 | .44 | .50 | .52 | .58 |
| 24 | 4 | .29 | .30 | .37 | .38 | .39 | .40 | .57 | .62 | .65 | .70 |
| 30 | 2 | .14 | .15 | .19 | .19 | .20 | .21 | .31 | .34 | .37 | .41 |
| 30 | 3 | .22 | .23 | .28 | .28 | .29 | .30 | .44 | .46 | .50 | .54 |
| 30 | 4 | .29 | .30 | .37 | .37 | .38 | .39 | .56 | .59 | .62 | .66 |
| 36 | 2 | .14 | .14 | .18 | .19 | .20 | .21 | .30 | .33 | .35 | .38 |
| 36 | 3 | .22 | .22 | .27 | .28 | .29 | .30 | .42 | .46 | .48 | .50 |
| 36 | 4 | .29 | .29 | .36 | .37 | .38 | .39 | .55 | .58 | .60 | .63 |
| 42 | 2 | .14 | .14 | .18 | .19 | .19 | .20 | .29 | .32 | .34 | .36 |
| 42 | 3 | .22 | .22 | .27 | .28 | .28 | .29 | .42 | .44 | .46 | .48 |
| 42 | 4 | .29 | .29 | .36 | .37 | .37 | .38 | .54 | .57 | .59 | .61 |
| 48 | 2 | .14 | .14 | .18 | .18 | .19 | .20 | .29 | .31 | .32 | .35 |
| 48 | 3 | .22 | .22 | .27 | .27 | .28 | .29 | .42 | .44 | .44 | .48 |
| 48 | 4 | .29 | .29 | .36 | .36 | .37 | .38 | .54 | .56 | .57 | .60 |
| 54 | 2 | .15 | .15 | .18 | .19 | .19 | .20 | .28 | .30 | .32 | .34 |
| 54 | 3 | .22 | .22 | .27 | .27 | .28 | .28 | .41 | .43 | .44 | .46 |
| 54 | 4 | .29 | .29 | .35 | .36 | .36 | .37 | .53 | .55 | .57 | .59 |
| 60 | 2 | .14 | .14 | .18 | .19 | .19 | .20 | .28 | .30 | .31 | .33 |
| 60 | 3 | .22 | .22 | .27 | .27 | .28 | .28 | .41 | .42 | .44 | .46 |
| 64 | 2 | .14 | .14 | .18 | .18 | .19 | .20 | .28 | .30 | .31 | .33 |
| 64 | 3 | .22 | .22 | .27 | .27 | .27 | .28 | .41 | .42 | .44 | .45 |
| 64 | 4 | .29 | .29 | .35 | .36 | .36 | .37 | .53 | .55 | .56 | .50 |

Based on data in Appendix of AWWA C151.



Taps in Ductile Iron Pipe AWWA C800 Standard

Thickness that will affect two, three and four full threads for different size taps with AWWA C800 Standard Corporation Stop Threads.*

Table No. 17-11

| Pipe Size in. | No. of Threads | Tap Size - in. | | | | | | |
|---------------|----------------|----------------------|-----|-----|-----|-------|-------|-----|
| | | 1/2 | 5/8 | 3/4 | 1 | 1 1/4 | 1 1/2 | 2 |
| | | Pipe Thickness - in. | | | | | | |
| 3 | 2 | .21 | .24 | .25 | .33 | | | |
| 3 | 3 | .29 | .32 | .33 | .41 | | | |
| 3 | 4 | .36 | .39 | .40 | .49 | | | |
| 4 | 2 | .19 | .22 | .23 | .30 | .36 | | |
| 4 | 3 | .27 | .30 | .31 | .38 | .45 | | |
| 4 | 4 | .34 | .37 | .38 | .46 | .54 | | |
| 6 | 2 | .18 | .20 | .20 | .26 | .30 | .35 | |
| 6 | 3 | .26 | .28 | .28 | .34 | .39 | .44 | |
| 6 | 4 | .33 | .35 | .35 | .42 | .48 | .53 | |
| 8 | 2 | .17 | .18 | .19 | .24 | .27 | .31 | .39 |
| 8 | 3 | .25 | .26 | .27 | .32 | .36 | .40 | .48 |
| 8 | 4 | .32 | .33 | .34 | .40 | .45 | .49 | .57 |
| 10 | 2 | .17 | .17 | .18 | .23 | .25 | .28 | .35 |
| 10 | 3 | .25 | .25 | .26 | .31 | .34 | .37 | .44 |
| 10 | 4 | .32 | .32 | .33 | .39 | .43 | .46 | .53 |
| 12 | 2 | .16 | .17 | .17 | .22 | .24 | .26 | .32 |
| 12 | 3 | .24 | .25 | .25 | .30 | .33 | .35 | .41 |
| 12 | 4 | .31 | .32 | .32 | .38 | .42 | .44 | .50 |
| 14 | 2 | .16 | .17 | .17 | .21 | .23 | .25 | .30 |
| 14 | 3 | .24 | .25 | .25 | .29 | .32 | .34 | .39 |
| 14 | 4 | .31 | .32 | .32 | .37 | .41 | .43 | .48 |
| 16 | 2 | .16 | .16 | .17 | .21 | .22 | .24 | .28 |
| 16 | 3 | .24 | .24 | .25 | .29 | .31 | .33 | .37 |
| 16 | 4 | .31 | .31 | .32 | .37 | .40 | .42 | .46 |
| 18 | 2 | .15 | .16 | .16 | .20 | .21 | .23 | .27 |
| 18 | 3 | .23 | .24 | .24 | .28 | .30 | .32 | .36 |
| 18 | 4 | .30 | .31 | .31 | .36 | .39 | .41 | .45 |
| 20 | 2 | .15 | .16 | .16 | .20 | .21 | .23 | .26 |
| 20 | 3 | .23 | .24 | .24 | .28 | .30 | .32 | .35 |
| 20 | 4 | .30 | .31 | .31 | .36 | .39 | .41 | .44 |
| 24 | 2 | .15 | .15 | .16 | .19 | .21 | .22 | .24 |
| 24 | 3 | .23 | .23 | .24 | .27 | .30 | .31 | .33 |
| 24 | 4 | .30 | .30 | .31 | .35 | .39 | .40 | .42 |
| 30 | 2 | .15 | .15 | .16 | .19 | .20 | .21 | .23 |
| 30 | 3 | .23 | .23 | .24 | .27 | .29 | .30 | .32 |
| 30 | 4 | .30 | .30 | .31 | .35 | .38 | .39 | .41 |
| 36 | 2 | .14 | .15 | .15 | .19 | .20 | .20 | .22 |
| 36 | 3 | .22 | .23 | .23 | .27 | .29 | .29 | .31 |
| 36 | 4 | .29 | .30 | .30 | .35 | .38 | .38 | .40 |
| 42 | 2 | .14 | .14 | .15 | .18 | .19 | .20 | .21 |
| 42 | 3 | .22 | .22 | .23 | .26 | .28 | .29 | .30 |
| 42 | 4 | .29 | .29 | .30 | .34 | .37 | .38 | .39 |
| 48 | 2 | .14 | .14 | .15 | .18 | .18 | .19 | .20 |
| 48 | 3 | .22 | .22 | .23 | .26 | .27 | .28 | .29 |
| 48 | 4 | .29 | .29 | .30 | .34 | .36 | .37 | .38 |
| 54 | 2 | .14 | .14 | .14 | .17 | .18 | .19 | .20 |
| 54 | 3 | .22 | .22 | .22 | .25 | .27 | .28 | .29 |
| 54 | 4 | .29 | .29 | .29 | .34 | .36 | .36 | .38 |
| 60 | 2 | .14 | .14 | .14 | .17 | .18 | .19 | .20 |
| 60 | 3 | .22 | .22 | .22 | .25 | .27 | .28 | .29 |
| 60 | 4 | .29 | .29 | .29 | .34 | .36 | .36 | .38 |
| 64 | 2 | .14 | .14 | .15 | .17 | .18 | .19 | .20 |
| 64 | 3 | .22 | .22 | .22 | .25 | .27 | .28 | .29 |
| 64 | 4 | .29 | .29 | .29 | .34 | .36 | .36 | .38 |

*This thread is commonly known to the trade as the Mueller thread. Based on data in Appendix 17-22 of AWWA C151.



Linear Expansion of Ductile Iron Pipe

The coefficient of linear expansion of ductile iron may be taken as 0.0000062 (.62 x 10⁻⁵) per degree Fahrenheit. The expansion or contraction in inches that will take place in a line of given length with various temperature changes is shown in the following table:

Table No. 17-12

| Temp Difference °F | Length of Line in Feet | | | | |
|-----------------------|------------------------------------|------|------|-------|-------|
| | 20' | 100' | 500' | 1000' | 5280' |
| | Expansion or Contraction in Inches | | | | |
| 5 | 0.007 | 0.04 | 0.19 | 0.37 | 1.96 |
| 10 | 0.015 | 0.07 | 0.37 | 0.74 | 3.93 |
| 20 | 0.030 | 0.15 | 0.74 | 1.49 | 7.86 |
| 30 | 0.045 | 0.22 | 1.12 | 2.23 | 11.78 |
| 40 | 0.060 | 0.30 | 1.49 | 2.98 | 15.71 |
| 50 | 0.074 | 0.37 | 1.86 | 3.72 | 19.64 |
| 60 | 0.089 | 0.45 | 2.23 | 4.46 | 23.57 |
| 70 | 0.104 | 0.52 | 2.60 | 5.21 | 27.50 |
| 80 | 0.119 | 0.60 | 2.98 | 5.95 | 31.43 |
| 90 | 0.134 | 0.67 | 3.35 | 6.70 | 35.35 |
| 100 | 0.149 | 0.74 | 3.72 | 7.44 | 39.28 |
| 120 | 0.179 | 0.89 | 4.46 | 8.93 | 47.14 |
| 150 | 0.223 | 1.12 | 5.58 | 11.16 | 58.92 |

Note: For related information, the approximate coefficient of linear expansion of other pipe and construction materials are as follows:

- Concrete – .7 x 10⁻⁵ in./in./°F
- HDPE – 10 to 12 x 10⁻⁵ in./in./°F
- PVC – 3.1 x 10⁻⁵ in./in./°F
- Steel – .65 x 10⁻⁵ in./in./°F



This bridge crossing illustrates design/construction advantages, including the deflection capabilities of AMERICAN Flex-Ring Joint Pipe.



Pipe Length Calculations for Offset Connections

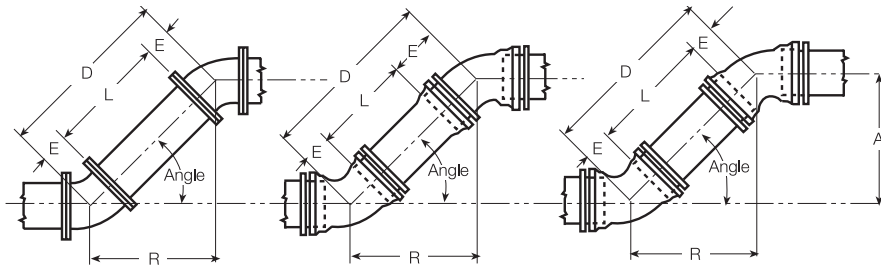

Table No. 17-13

| Angle | D Equals | R Equals | L Equals | |
|---------|-----------|-----------|-------------|----------------------------|
| | | | Flg Pipe | FST Pipe |
| 45° | A x 1.41 | A x 1.00 | D - (2 x E) | D - (2 x E) or D - (E + S) |
| 22 1/2° | A x 2.61 | A x 2.41 | D - (2 x E) | D - (2 x E) or D - (E + S) |
| 11 1/4° | A x 5.13 | A x 5.03 | D - (2 x E) | D - (2 x E) or D - (E + S) |
| 5 5/8° | A x 10.20 | A x 10.15 | D - (2 x E) | D - (2 x E) or D - (E + S) |

Allowance in flange joint (usually 1/8" for gasket) and in Fastite joint (usually 1/4") should be taken into account in determination of required pipe length. Likewise, extension of restrained joints subjected to thrust load in installation and/or service should be considered as well.



Pipe Length Calculations for Inclined Diagonal Runs

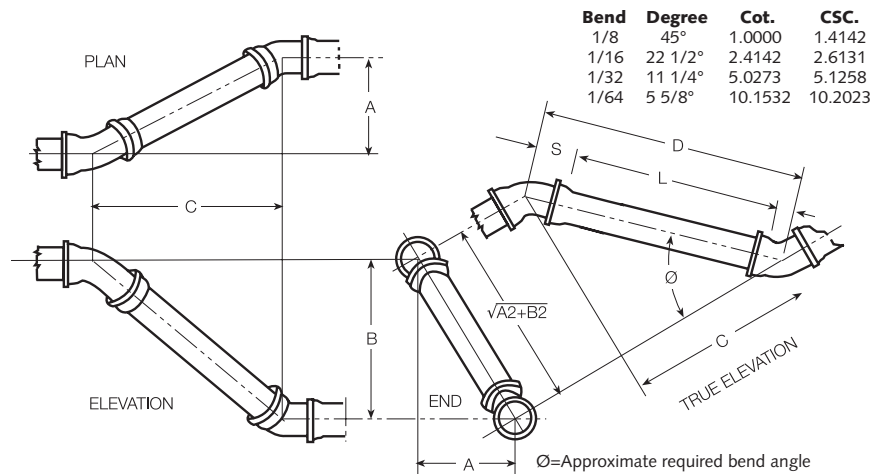

Sketch explanatory of formulas for lengths of pipe for diagonal runs and angle of fittings

The following examples illustrate means of determining lengths of pipe and tie rods on inclined diagonal runs, and finding the approximate angle, \emptyset , required when the dimensions in three planes are known.

A. — When measurements in two planes are known and angle of fitting \emptyset decided upon, then

$$C = \sqrt{A^2 + B^2} \times \text{Cot } \emptyset \text{ Formula (I)}$$

$$D = \sqrt{A^2 + B^2} \times \text{Csc } \emptyset \text{ Formula (II)}$$

Example: If $A = 8'-0''$, $B = 9'-6''$, $\emptyset = 45^\circ$
Find C and length of pipe required on 12" line.

$$D = \sqrt{(8)^2 + (9.5)^2} \times \text{Csc } 45^\circ$$

$$= \sqrt{64 + 90.25} \times 1.4142$$

$$= 17.56' = 17'-6\frac{3}{4}''$$

$$C = \sqrt{(8)^2 + (9.5)^2} \times \text{Cot } 45^\circ$$

$$= \sqrt{64 + 90.25} \times 1$$

$$= 12.42 \times 1 = 12.42' = 12'-5''$$

$$L = D - (E + S)$$

$$= 17'-6\frac{3}{4}'' - (5'1/2'' + 13'1/2'')$$

$$= 15'-11\frac{3}{4}''$$

B. — When measurements in three planes are known, then

$$D = \sqrt{A^2 + B^2 + C^2} \text{ Formula (III)}$$

$$\text{Tan } \emptyset = \frac{\sqrt{A^2 + B^2}}{C} \text{ Formula (IV)}$$

Example: If $A = 5'-6''$, $B = 3'-0''$,
 $C = 14'-9''$
Find \emptyset and length of pipe required on 8" line.

$$D = \sqrt{(5.5)^2 + (3)^2 + (14.75)^2}$$

$$= \sqrt{30.25 + 9 + 217.56} = 16.025'$$

$$= 16'-05\frac{1}{16}''$$

$$\text{Tan } \emptyset = \frac{\sqrt{(5.5)^2 + (3)^2}}{14.75} = \frac{\sqrt{30.25 + 9}}{14.75}$$

$$= \frac{\sqrt{39.25}}{14.75} = \frac{6.265}{14.75} = 0.42474$$

$\emptyset = 23^\circ+$ and a one-sixteenth bend may be used.

$$L = D - (E + S)$$

$$= 16'-0\frac{5}{16}'' - (5'1/2'' + 13'1/2'')$$

$$= 14'-5\frac{5}{16}''$$

For center-to-socket dimensions of Fastite fittings see Section 7. For center-to-face dimensions of flange fittings see Section 9.

Allowance in flange joint (usually 1/8" for gasket) and in mechanical joint (usually 1/4") should be taken into account in determination of required pipe length. Likewise, extension of restrained joints subjected to axial thrust load in installation and/or service should be considered as well.



Mathematical Formulas

Solution of Right Triangle

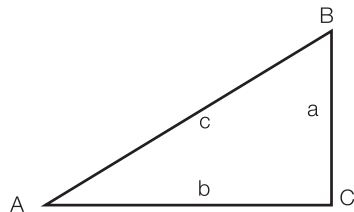

$$a^2 + b^2 = c^2$$

$$\sin A = \frac{a}{c}$$

$$\cos A = \frac{b}{c}$$

$$\tan A = \frac{a}{b}$$

$$\cot A = \frac{b}{a}$$

$$\sec A = \frac{c}{b}$$

$$\csc A = \frac{c}{a}$$

Solution of Oblique Triangle

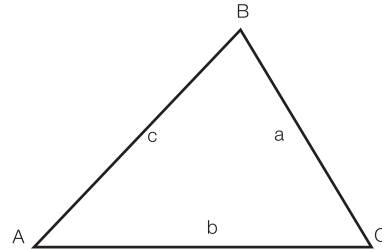

$$A + B + C = 180^\circ$$

Law of Sines

$$\frac{a}{\sin A} = \frac{b}{\sin B} = \frac{c}{\sin C}$$

Law of Cosines:

$$c^2 = a^2 + b^2 - 2ab \cos C$$

Law of Tangents

$$\frac{a + b}{a - b} = \frac{\tan 1/2 (A+B)}{\tan 1/2 (A-B)}$$

Plane Figures

A = Area

C = Circumference

$\pi = 3.1415926536$

Parallelogram

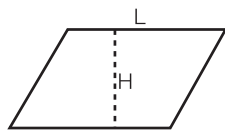

$$A = H \times L$$

Triangle

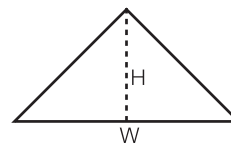

$$A = 1/2 WH$$

Trapezoid

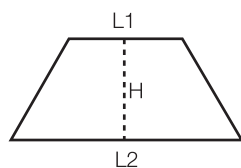

$$A = 1/2 H(L1 + L2)$$

Circle

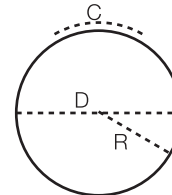

$$C = \pi D$$

$$A = 1/4 \pi D^2$$



Mathematical Formulas - Continued

Segment of a Circle

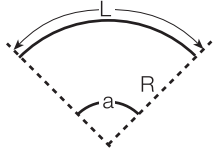

$$A = \pi R^2 \times a \div 360$$

$$L = 2\pi R \times a \div 360$$

Ellipse

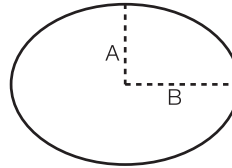

$$A = \pi AB$$

$$C = 2\pi \sqrt{1/2 (A^2 + B^2)} \quad (\text{approximate formula})$$

Solid Figures

V = Volume

Cone

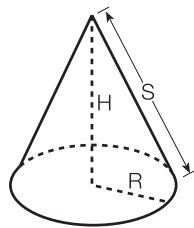

$$A = \pi R (S + R)$$

$$A_1 = \pi RS \quad (\text{Lateral Area})$$

$$V = \frac{\pi}{3} R^2 H$$

Elliptical Tank

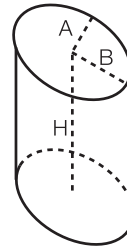

$$A = 2\pi AB + 2\pi H \sqrt{1/2(A^2 + B^2)}$$

$$V = \pi ABH$$

$$A_1 = 2\pi H \sqrt{1/2(A^2 + B^2)} \quad (\text{Lateral Area})$$

Cylinder

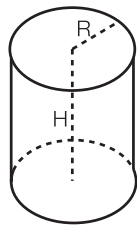

$$A = 2\pi R (H + R)$$

$$A_1 = \pi RH \quad (\text{Lateral Area})$$

$$V = \pi R^2 H$$

Sphere

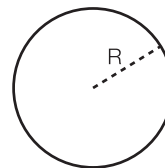

$$A = 4\pi R^2$$

$$V = \frac{4}{3} \pi R^3$$



Mathematical Formulas - Continued

Torus

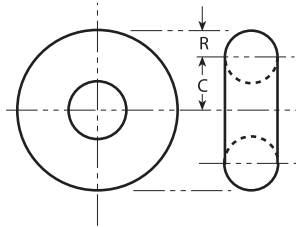

$$A = 4\pi^2 CR$$

$$V = 2\pi^2 CR^2$$

Frustum of Cone

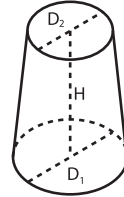

$$V = \frac{1}{12} \pi H [(D_1^2 + D_2^2) + (D_1 \times D_2)]$$



AMERICAN'S STANDARD COLOR CODES

AMERICAN routinely paints different colored marks on certain products to help differentiate them and facilitate identification.

Painted daub(s) on face of bell

| | |
|--------|--|
| Pink | Coal Tar Epoxy |
| Red | Full-length pipe cut shorter than nominal as allowed by AWWA Standards |
| Orange | Zinc Coating |

Painted face of bell

| | |
|-------|----------------------------------|
| White | Special deflection Fastite bells |
|-------|----------------------------------|

Painted band immediately behind bell

| | |
|-------|--|
| Blue | Pipe with taps, welded-on bosses or outlets. (Blue circle also painted around the tap, boss, or outlet.) |
| Green | Pipe gauged full length for field cutting |

Notes:

- Products to be furnished with special coatings, primers, etc., on the O.D. will not have color codings.
- Color codings are subject to change without notice. Contact AMERICAN for current codings.
- If special color codes are required to meet specific project requirements, the above colors should be avoided if at all possible.
- Other markings in addition to color codes may be painted or stencilled on products.



Decimal of an Inch and of a Foot

Table No. 17-14

| Fractions of Inch or Foot | | Inch Equivalents to Foot Fractions | Fractions of Inch or Foot | | Inch Equivalents to Foot Fractions | Fractions of Inch or Foot | | Inch Equivalents to Foot Fractions | Fractions of Inch or Foot | | Inch Equivalents to Foot Fractions | | | | |
|---------------------------|---------|------------------------------------|---------------------------|---------|------------------------------------|---------------------------|---------|------------------------------------|---------------------------|---------|------------------------------------|---------|-------|---------|----------|
| 1/64 | .0052 | 1/16 | 17/64 | .2552 | 3 1/16 | 33/64 | .5052 | 6 1/16 | 49/64 | .7552 | 9 1/16 | | | | |
| | .0104 | 1/8 | | .2604 | 3 1/8 | | .5104 | 6 1/8 | | .7604 | 9 1/8 | | | | |
| | .015625 | 3/16 | | .265625 | 3 3/16 | | .515625 | 6 3/16 | | .765625 | 9 3/16 | | | | |
| | .0208 | 1/4 | | .2708 | 3 1/4 | | .5208 | 6 1/4 | | .7708 | 9 1/4 | | | | |
| | .0260 | 5/16 | | .2760 | 3 5/16 | | .5260 | 6 5/16 | | .7760 | 9 5/16 | | | | |
| 1/32 | .03125 | 3/8 | 9/32 | .28125 | 3 3/8 | 17/32 | .53125 | 6 3/8 | 25/32 | .78125 | 9 3/8 | | | | |
| | .0365 | 7/16 | | .2865 | 3 7/16 | | .5365 | 6 7/16 | | .7865 | 9 7/16 | | | | |
| | .0417 | 1/2 | | .2917 | 3 1/2 | | .5417 | 6 1/2 | | .7917 | 9 1/2 | | | | |
| | .046875 | 9/16 | | .296875 | 3 9/16 | | .546875 | 6 9/16 | | .796875 | 9 9/16 | | | | |
| | .0521 | 5/8 | | .3021 | 3 5/8 | | .5521 | 6 5/8 | | .8021 | 9 5/8 | | | | |
| 1/16 | .0573 | 1 1/16 | 5/16 | .3073 | 3 1 1/16 | 9/16 | .5573 | 6 1 1/16 | 13/16 | .8073 | 9 1 1/16 | | | | |
| | .0625 | 3/4 | | .3125 | 3 3/4 | | .5625 | 6 3/4 | | .8125 | 9 3/4 | | | | |
| | .0677 | 13/16 | | .3177 | 3 13/16 | | .5677 | 6 13/16 | | .8177 | 9 13/16 | | | | |
| | .0729 | 7/8 | | .3229 | 3 7/8 | | .5729 | 6 7/8 | | .8229 | 9 7/8 | | | | |
| | .078125 | 15/16 | | .328125 | 3 15/16 | | .578125 | 6 15/16 | | .828125 | 9 15/16 | | | | |
| 3/32 | .0833 | 1 | 11/32 | .3333 | 4 | 19/32 | .5833 | 7 | 27/32 | .8333 | 10 | | | | |
| | .0885 | 1 1/16 | | .3385 | 4 1/16 | | .5885 | 7 1/16 | | .8385 | 10 1/16 | | | | |
| | .09375 | 1 1/8 | | .34375 | 4 1/8 | | .59375 | 7 1/8 | | .84375 | 10 1/8 | | | | |
| | .0990 | 1 3/16 | | .3490 | 4 3/16 | | .5990 | 7 3/16 | | .8490 | 10 3/16 | | | | |
| | .1042 | 1 1/4 | | .3542 | 4 1/4 | | .6042 | 7 1/4 | | .8542 | 10 1/4 | | | | |
| 7/64 | .109375 | 1 5/16 | 23/64 | .359375 | 4 5/16 | 39/64 | .609375 | 7 5/16 | 55/64 | .859375 | 10 5/16 | | | | |
| | .1146 | 1 3/8 | | .3646 | 4 3/8 | | .6146 | 7 3/8 | | .8646 | 10 3/8 | | | | |
| | .1198 | 1 7/16 | | .3698 | 4 7/16 | | .6198 | 7 7/16 | | .8698 | 10 7/16 | | | | |
| | .1250 | 1 1/2 | | .3750 | 4 1/2 | | .6250 | 7 1/2 | | .8750 | 10 1/2 | | | | |
| | .1302 | 1 9/16 | | .3802 | 4 9/16 | | .6302 | 7 9/16 | | .8802 | 10 9/16 | | | | |
| 9/64 | .1354 | 1 5/8 | 25/64 | .3854 | 4 5/8 | 41/64 | .6354 | 7 5/8 | 57/64 | .8854 | 10 5/8 | | | | |
| | .140625 | 1 11/16 | | .390625 | 4 11/16 | | .640625 | 7 11/16 | | .890625 | 10 11/16 | | | | |
| | .1458 | 1 3/4 | | .3958 | 4 3/4 | | .6458 | 7 3/4 | | .8958 | 10 3/4 | | | | |
| | .1510 | 1 13/16 | | .4010 | 4 13/16 | | .6510 | 7 13/16 | | .9010 | 10 13/16 | | | | |
| | .15625 | 1 7/8 | | .40625 | 4 7/8 | | .65625 | 7 7/8 | | .90625 | 10 7/8 | | | | |
| 11/64 | .1615 | 1 15/16 | 27/64 | .4115 | 4 15/16 | 43/64 | .6615 | 7 15/16 | 59/64 | .9115 | 10 15/16 | | | | |
| | .1667 | 2 | | .4167 | 5 | | .6667 | 8 | | .9167 | 11 | | | | |
| | .171875 | 2 1/16 | | .421875 | 5 1/16 | | .671875 | 8 1/16 | | .921875 | 11 1/16 | | | | |
| | .1771 | 2 1/8 | | .4271 | 5 1/8 | | .6771 | 8 1/8 | | .9271 | 11 1/8 | | | | |
| | .1823 | 2 3/16 | | .4323 | 5 3/16 | | .6823 | 8 3/16 | | .9323 | 11 3/16 | | | | |
| 3/16 | .1875 | 2 1/4 | 7/16 | .4375 | 5 1/4 | 11/16 | .6875 | 8 1/4 | 15/16 | .9375 | 11 1/4 | | | | |
| | .1927 | 2 5/16 | | .4427 | 5 5/16 | | .6927 | 8 5/16 | | .9427 | 11 5/16 | | | | |
| | .1979 | 2 3/8 | | .4479 | 5 3/8 | | .6979 | 8 3/8 | | .9479 | 11 3/8 | | | | |
| | .203125 | 2 7/16 | | .453125 | 5 7/16 | | .703125 | 8 7/16 | | .953125 | 11 7/16 | | | | |
| | .2083 | 2 1/2 | | .4583 | 5 1/2 | | .7083 | 8 1/2 | | .9583 | 11 1/2 | | | | |
| 7/32 | .2135 | 2 9/16 | 15/32 | .4635 | 5 9/16 | 23/32 | .7135 | 8 9/16 | 31/32 | .9635 | 11 9/16 | | | | |
| | .21875 | 2 5/8 | | .46875 | 5 5/8 | | .71875 | 8 5/8 | | .96875 | 11 5/8 | | | | |
| | .2240 | 2 11/16 | | .4740 | 5 11/16 | | .7240 | 8 11/16 | | .9740 | 11 11/16 | | | | |
| | .2292 | 2 3/4 | | .4792 | 5 3/4 | | .7292 | 8 3/4 | | .9792 | 11 3/4 | | | | |
| | 15/64 | .234375 | | 2 13/16 | 31/64 | | .484375 | 5 13/16 | | 47/64 | .734375 | 8 13/16 | 63/64 | .984375 | 11 13/16 |
| .2396 | | 2 7/8 | .4896 | 5 7/8 | | .7396 | 8 7/8 | .9896 | 11 7/8 | | | | | | |
| .2448 | | 2 15/16 | .4948 | 5 15/16 | | .7448 | 8 15/16 | .9948 | 11 15/16 | | | | | | |
| 1/4 | | .2500 | 3 | 1/2 | | .5000 | 6 | 3/4 | .7500 | | 9 | 1 | | 1.0000 | 12 |



Equivalents and Conversion Factors English

The word gallon, used in any conversion factor, designates the U.S. gallon. Likewise, the word ton designates a short ton, 2,000 pounds.

The figures 10^{-1} , 10^{-2} , 10^{-3} , etc., denote 0.1, 0.01, 0.001, etc., respectively.

The figures 10^1 , 10^2 , 10^3 , etc., denote 10, 100, 1000, etc., respectively.

"Parts Per Million," (designated as p.p.m.), is always by weight. As used in the sanitary field, p.p.m. represents the number of pounds of dry solids contained in one million pounds of water. In this field, one part per million may be expressed as 8.345 pounds of dry solids to one million U.S. gallons of water.

Conversion factors are based on water at a temperature of 4°C unless otherwise noted.

Table No. 17-15

| Multiply | By | To Obtain |
|-------------------------------|-------------------------|-------------------|
| Acres..... | 43,560 | Square feet |
| Acre-feet..... | 43,560 | Cubic feet |
| Acre-feet..... | 325,851 | Gallons |
| Atmospheres | 29.92 | Inches of mercury |
| Atmospheres | 33.90 | Feet of water |
| Atmospheres | 14.70 | Lbs/sq. inch |
| Barrels cement..... | 376 | Pounds-cement |
| Bags or sacks-cement | 94 | Pounds-cement |
| B.T.U. | 778.17 | Foot-lbs |
| B.T.U. | 3.9301×10^{-4} | Horsepower-hrs. |
| B.T.U. | 2.9306×10^{-4} | Kilowatt-hrs. |
| B.T.U./min. | 12.970 | Foot-lbs/sec. |
| B.T.U./min. | 0.023581 | Horsepower |
| B.T.U./min. | 0.017584 | Kilowatts |
| Cubic feet | 7.48052 | Gallons |
| Cubic feet | 1728 | Cubic inches |
| Cubic feet | 0.03704 | Cubic yards |
| Cubic feet/second..... | 0.646317 | Million gals./day |
| Cubic feet/second..... | 448.831 | Gallons/min. |
| Cubic inches..... | 5.787×10^{-4} | Cubic feet |
| Cubic inches..... | 4.329×10^{-3} | Gallons |
| Cubic yards | .27 | Cubic feet |
| Cubic yards | 46,656 | Cubic inches |
| Cubic yards | 202.0 | Gallons |
| Drams | 27.34375 | Grains |
| Drams | 0.0625 | Ounces |
| Fathoms | .6 | Feet |
| Feet of water..... | 0.8826 | Inches of mercury |
| Feet of water (at 62°F) | 0.4330 | Lbs/sq. inch |
| Feet of water | 62.427 | Lbs/sq. feet |
| Feet of water..... | 0.02950 | Atmospheres |
| Foot-pounds | 1.285×10^{-3} | B.T.U. |
| Foot-pounds | 5.0505×10^{-7} | Horsepower-hrs. |
| Foot-pounds | 3.766×10^{-7} | Kilowatt-hrs. |
| Foot-pounds/min. | 3.0303×10^{-5} | Horsepower |
| Foot-pounds/min. | 2.260×10^{-5} | Kilowatts |
| Gallons..... | 0.13368 | Cubic feet |
| Gallons..... | .231 | Cubic inches |
| Gallons, Imperial | 1.20095 | U.S. gallons |
| Gallons, U.S. | 0.83267 | Imperial gallons |
| Gallons water (at 4°C)..... | 8.3453 | Pounds of water |
| Gallons water (at 62°F) | 8.3355 | Pounds of water |
| Gallons/min. | 2.228×10^{-3} | Cubic feet/sec. |
| Gallons/min. | 8.0208 | Cu.ft./hr. |
| Grains (troy)..... | .1 | Grains (avoir.) |



Equivalents and Conversion Factors English

Table No. 17-15 - Continued

| Multiply | By | To Obtain |
|-----------------------|------------------------|-------------------|
| Grains | 0.06480 | Grams |
| Grains/U.S. gal. | 17.119 | Parts/million |
| Grains/U.S. gal. | 142.86 | Lbs/million gal. |
| Grains/Imp. gal. | 14.254 | Parts/million |
| Hectares | 2.471 | Acres |
| Horsepower | 42.407 | B.T.U./min. |
| Horsepower | 550 | Foot-lbs/sec. |
| Horsepower | 0.7457 | Kilowatts |
| Horsepower (boiler) | 33,520 | B.T.U./hr. |
| Horsepower (boiler) | 9.824 | Kilowatts |
| Inches | 1.0×10^{-3} | Mils |
| Inches of mercury | 1.133 | Feet of water |
| Inches of mercury | 0.4912 | Lbs/sq. inch |
| Inches of mercury | 0.03342 | Atmospheres |
| Inches of water | 0.07355 | Inches of mercury |
| Inches of water | 0.03613 | Lbs/sq. inch |
| Kilowatts | 56.87 | B.T.U./min. |
| Kilowatts | 737.5 | Foot-lbs/sec. |
| Kilowatts | 1.341 | Horsepower |
| Miles | 5280 | Feet |
| Miles/min. | .88 | Feet/sec. |
| Million gals./day | 1.54723 | Cubic ft./sec. |
| Miner's inches | 1.5 | Cubic ft./min. |
| Ounces | 437.5 | Grains |
| Ounces | 0.9115 | Ounces (troy) |
| Ounces (fluid) | 1.805 | Cubic inches |
| Parts/million | 8.345 | Lbs/million gal. |
| Parts/million | 0.058415 | Grains/U.S. gal. |
| Parts/million | 0.07016 | Grains/Imp. gal. |
| Pounds | .16 | Ounces |
| Pounds | 7000 | Grains |
| Pounds | 1.21528 | Pounds (troy) |
| Pounds of water | 0.01602 | Cubic feet |
| Pounds of water | 27.68 | Cubic inches |
| Pounds of water | 0.1198 | Gallons |
| Pounds/cubic foot | 5.787×10^{-4} | Lbs/cubic inch |
| Pounds/sq. foot | 0.01602 | Feet of water |
| Pounds/sq. inch | 2.307 | Feet of water |
| Pounds/sq. inch | 2.0358 | Inches of mercury |
| Pounds/sq. inch | 0.06803 | Atmospheres |
| Quires | .25 | Sheets |
| Reams | 500 | Sheets |
| Square feet | 144 | Square inches |
| Square feet | 2.296×10^{-5} | Acres |
| Square miles | .640 | Acres |
| Square miles | 2.788×10^7 | Square feet |
| Square yards | .9 | Square feet |
| Square yards | 2.066×10^{-4} | Acres |
| Tons (long) | 2240 | Pounds |
| Tons (long) | 1.12 | Tons (short) |
| Tons (short) | 2000 | Pounds |
| Tons of water/24 hrs. | 0.16639 | Gallons/min. |
| Watts | 0.05686 | B.T.U./min. |
| Watts | 0.7375 | Foot-pounds/sec. |
| Watts | 1.341×10^{-3} | Horsepower |

Conversion Factors are based on water at a temperature of 4°C unless otherwise noted.



Equivalents and Conversion Factors Metric

Table No. 17-16

| Multiply | By | To Obtain |
|------------------------------|---------------------------|------------------------|
| Acres..... | 4047 | Square meters |
| Acre-feet..... | 1233.5 | Cubic meters |
| Atmosphere..... | 1.01325 | Bars |
| Atmospheres..... | 76.0 | Centimeters of mercury |
| Bars..... | 0.98692 | Atmosphere |
| Bars..... | 1.02 x 10 ⁴ | Kgs./sq. meter |
| Bars..... | 14.50777 | Pounds/sq. in. |
| Bars..... | 10.20 | Meters of water |
| B.T.U. | 0.2520 | Kilogram calories |
| B.T.U. | 107.6 | Kilogram meters |
| Centimeters | 0.3937 | Inches |
| Centimeters of mercury..... | 0.01316 | Atmospheres |
| Centimeters of mercury..... | 0.4461 | Feet of water |
| Centimeters of mercury..... | 27.85 | Pounds/sq. ft. |
| Centimeters of mercury..... | 0.1934 | Pounds/sq. in. |
| Centimeters/second..... | 1.969 | Feet/minute |
| Centimeters/second..... | 0.03281 | Feet/sec. |
| Centimeters/second..... | 0.6 | Meters/min. |
| Cubic centimeters | 3.531 x 10 ⁻⁵ | Cubic feet |
| Cubic centimeters | 6.102 x 10 ⁻² | Cubic inches |
| Cubic centimeters | 2.642 x 10 ⁻⁴ | Gallons |
| Cubic centimeters..... | 10 ⁻⁶ | Cubic meters |
| Cubic centimeters..... | 10 ⁻³ | Liters |
| Cubic feet | 28.32 | Liters |
| Cubic feet | 2.832 x 10 ⁴ | Cubic centimeters |
| Cubic feet | 0.02832 | Cubic meters |
| Cubic inches..... | 16.39 | Cubic centimeters |
| Cubic inches..... | 1.639 x 10 ⁻⁵ | Cubic meters |
| Cubic inches..... | 1.639 x 10 ⁻² | Liters |
| Cubic meters..... | 35.31 | Cubic feet |
| Cubic meters..... | 1.308 | Cubic yards |
| Cubic meters..... | 264.2 | Gallons |
| Cubic meters..... | 103 | Liters |
| Cubic yards | 0.7646 | Cubic meters |
| Cubic yards | 764.6 | Liters |
| Dram | 1.771845 | Grams |
| Feet | 30.48 | Centimeters |
| Feet | 0.3048 | Meters |
| Feet of water | 304.8 | Kgs./sq. meter |
| Feet/sec./sec..... | 0.3048 | Meters/sec./sec. |
| Feet/sec. | 30.48 | Centimeters/sec. |
| Feet/sec. | 18.29 | Meters/minute |
| Foot-pounds | 0.1383 | Kilogram-meters |
| Gallons..... | 3.785 | Cubic centimeters |
| Gallons..... | 3.785 x 10 ⁻³ | Cubic meters |
| Gallons..... | 3.785 | Liters |
| Gallons/minute | 0.06308 | Liters/second |
| Gallons/minute | 6.308 x 10 ⁻⁵ | Cubic meters/sec. |
| Grams | 15.432 | Grains |
| Grams | 0.03527 | Ounces |
| Grams | 980.7 | Dynes |
| Grams/sq. centimeter..... | 0.9808 x 10 ⁻³ | Bars |
| Grams/liter..... | 58.410 | Grains/gal. |
| Grams/liter..... | 8.344 | Pounds/1000 gallons |
| Grams/liter..... | 1000 | Parts/million |
| Grams/cubic centimeter | 1.000 x 10 ³ | Kilograms/cubic meter |
| Inches | 2.540 | Centimeters |
| Inches | 25.4 | Millimeters (mm) |
| Inches of mercury | 345.3 | Kgs./sq. meter |



Equivalents and Conversion Factors Metric

Table No. 17-16 - Continued

| Multiply | By | To Obtain |
|-------------------------------|------------------------|--------------------------|
| Inches/second..... | 2.540×10^{-2} | Meters/second |
| Inches/sec./sec. | 2.540×10^{-2} | Meters/sec./sec. |
| Kilograms..... | 2.2046 | Pounds |
| Kilogram-calories/minute..... | .51.47 | Foot-pounds/sec. |
| Kilogram-calories/minute..... | 0.06979 | Kilowatts |
| Kilogram-calories/minute..... | 0.09359 | Horsepower |
| Kilograms/sq. meter..... | 1.422×10^{-3} | Pounds/sq. inch |
| Kilometers..... | 3281 | Feet |
| Kilometers..... | 0.6214 | Miles |
| Kilometers/hour | 0.9113 | Feet/sec. |
| Kilometers/hour | .27.78 | Centimeters/sec. |
| Kilowatts..... | 14.33 | Kg.-calories/min. |
| Liters..... | 0.2642 | Gallons |
| Liters..... | .61.02 | Cubic inches |
| Liters..... | 0.03531 | Cubic feet |
| Meters | 3.281 | Feet |
| Meters | .39.37 | Inches |
| Meters | 1.094 | Yards |
| Meters of water | 0.09803 | Bars |
| Meters of water | 1.422 | Pounds/sq. inch |
| Miles..... | 1.609 | Kilometers |
| Miles/minute | 1.609 | Kilometers/minute |
| Milligrams/liter..... | .1 | Parts/million |
| Millimeters | 0.03937 | Inches |
| Newton/Cubic meter | 6.365×10^{-3} | Pounds/cubic foot |
| Newtons/sq. millimeter | 145.045 | Pounds/sq.inch |
| Ounces | .28.3495 | Grams |
| Ounces (fluid) | .29.58 | Cubic centimeters |
| Pounds..... | .453.5924 | Grams |
| Pounds..... | 4.448 | Newtons |
| Pounds/cubic foot..... | 0.01602 | Grams/cubic centimeter |
| Pounds/cubic foot..... | 16.02 | Kilograms/cubic meter |
| Pounds/foot..... | 1.488 | Kilograms/meter |
| Pounds/inch..... | 178.6 | Grams/centimeter |
| Pounds/sq. inch | 0.06893 | Bars |
| Pounds/sq. foot | 4.883 | Kilograms/sq.meter |
| Pounds/sq. inch | 2.30947 | Feet of Water (at 62°F) |
| Pounds/sq. inch | .703.1 | Kilograms/sq.meter |
| Pounds/sq. inch | .6.895 | Kilopascals (kPa) |
| Pounds/sq. inch | 6.895×10^{-3} | Megapascals (MPa) |
| Square centimeters..... | 0.1550 | Square inches |
| Square centimeters..... | 1.076×10^{-3} | Square feet |
| Square feet | 0.09290 | Square meters |
| Square feet/second..... | 9.290×10^{-2} | Square meters/sec. |
| Square inches..... | 6.452 | Square centimeters |
| Square kilometers..... | .247.1 | Acres |
| Square kilometers..... | 1.076×10^7 | Square feet |
| Square kilometers..... | 1.196×10^6 | Square yards |
| Square meters | 10.76 | Square feet |
| Square meters | 1.196 | Square yards |
| Square miles..... | .2.590 | Square kilometers |
| Square yards | 0.8361 | Square meters |
| Tons (long) | 1016 | Kilograms |
| Tons (metric)..... | 10^3 | Kilograms |
| Tons (metric)..... | 2205 | Pounds |
| Tons (short) | 907.185 | Kilograms |
| Watts..... | 0.01433 | Kilogram-calories/minute |
| Yards | 0.9144 | Meters |

Conversion factors are based on water at a temperature of 4°C unless otherwise noted.



AMERICAN

DUCTILE IRON PIPE

THE RIGHT WAY

AMERICAN General Index





General Index

| | PAGE | | PAGE |
|-----------------------------------|---------------|------------------------------|--------------|
| A | | | |
| Abbreviations | | Long Radius | 6-8, 6-9 |
| Organizations | 1-1 | Reducing 90° | 6-9 |
| Standard, American | 17-14 | Side Outlet 90° | 12-31 |
| Abrasion Resistant Pipe | 12-12 | Bends — Flanged Standard | 6-8, 6-11 |
| Accessories (See Joint Materials) | | Bends — Flare (Bell Mouth) | 7-8 |
| Amarillo Gaskets | | Bends — Mechanical Joint, | |
| ANSI Standards (See Standards) | | Standard | 5-6 — 5-9 |
| Areas for Ductile Iron Pipe | 17-12 | Bevel, Field — Fastite Joint | 3-27 |
| Asphaltic Coating | 11-7 | Blind Flanges | |
| Asphaltic Lining | 11-4 | C110/A21.10 | 6-22 |
| Assembly Instructions | | B16.1 Class 250 | 12-33 |
| (See Joint Assembly Instructions) | | Bolt Torques | |
| ASTM | | Mechanical Joint | 2-21 |
| Culvert Pipe | 3-23 | MJ Coupled Joint | 9-40 |
| Gravity Sewer Pipe | 3-23 | MJ Retainer Gland | 12-41 |
| Standards (See Standards) | | Toruseal Flange Gasketed | |
| AWWA Standards | 1-4 | Joint | 8-3 |
| B | | | |
| Ball Joint Pipe | | Bolts | |
| Connections | 10-18 | Coupling Gland End | 9-40 |
| Flex-Lok | 10-2 | Flanged | 8-3 |
| General | Section 10 | Flanged C110/A21.10 & | |
| Installation | 10-15 — 10-18 | C153/A21.53 Fittings | 6-4 |
| Testing | 10-18 | Flanged C115/A21.15 Pipe | 8-4 |
| Base Bends | | Flanged B16.1 Class 25 | 12-29 |
| Flanged | 6-24 | Flanged B16.1 | |
| Mechanical Joint | 5-25 | Class 250 | 12-30, 8-12 |
| Base Flange Details | 6-26 | Mechanical Joint | 2-19 |
| Base Tees | | MJ Coupled Joint | 9-40 |
| Flanged | 6-25 | Retainer Glands | 12-41 |
| Mechanical Joint | 5-10 | Stud | 2-25, 8-4 |
| Bases, Supporting Pipe | 6-26 | Tee-Head | 2-24, 2-25 |
| Bell and Spigot Material | Section 12 | Bosses — | |
| Bell Mouth Fittings | 7-8 | Welded-on Pipe | 12-47, 12-48 |
| Bell Weights | 7-3 | B16.1 Class 25 | |
| Bends, Fastite | 4-6 — 4-9 | Flanged Fittings | 12-29 |
| Bends — Flanged Special | | B16.1 Class 250 | |
| B16.1 Class 250 | 12-29 | Flanged Fittings | 12-31 |
| Base 90° | 6-24 | C | |
| Flange — Flare 90° | 7-8 | Caps | |
| Flex-Ring | 4-6 — 4-9 | Flex-Ring | 4-17 |
| Lok-Ring | 4-6 — 4-9 | Lok-Ring | 4-17 |
| | | Mechanical Joint | 5-23 |



| | PAGE | | PAGE |
|------------------------------------|--------------|-------------------------------|------------|
| Cast Iron Pipe | | Couplings | |
| (Gray Iron) | Section 12 | Gland End Joint | 9-42 |
| Caulking Material | 12-3 | Grooved Joint | 2-22 |
| Cement Lining | | Shouldered Joint | 2-23 |
| Field Repair | 11-2 | Crosses | |
| General | 11-1 | Flanged, C110/A21.10 & | |
| Thicknesses and Weights | 11-3 | C153/A21.53 | 6-12 |
| Circumferences, | | Flanged, B16.1 Class 250 | 12-31 |
| Ductile Iron Pipe | 17-12 | Flanged Side Outlet | 6-19 |
| Classes of | | Flex-Ring | 4-10 |
| Ductile Iron Pipe | | Lok-Ring | 4-10 |
| Special Thickness Classes | 3-20 | Mechanical Joint | 5-10 |
| Standard Pressure Classes | 3-13 | Culvert Pipe | 3-23 |
| Fittings (AWWA) | 12-20 | Cutting Ductile Iron Pipe | 3-26 |
| Gray Iron Pipe | 12-5 | | |
| Clearances (See Joint Clearances) | | D | |
| Coal Tar Epoxy Lining | 11-8 | Decimal Equivalents | 17-31 |
| Coatings | | Deflection in Pipe Joints | |
| Asphaltic | 11-7 | (See Joint Deflection) | |
| High-Solids Epoxy Primer | 11-7 | Depths of Cover, Allowable | |
| Phenolic Alkyd Primer | 11-7 | Min. Pressure Classes Ductile | |
| Special | 11-8 | Iron Pipe | 3-17 |
| Uncoated | 11-8 | Ductile Iron Pipe | 3-18 |
| Collars | | Gravity Sewer Pipe | |
| Thrust | 9-43 | with Flexible Lining | 3-23 |
| Wall | 7-4 | Design, Pipe | |
| Color Codes, AMERICAN | 17-30 | Ductile Iron | 3-2 |
| Companion Flanges for | | History of | 1-2, 3-1 |
| Ductile Iron Pipe | | Ductile Iron — Definition | 3-1 |
| (C115/A21.15) | 8-5 | Ductile Iron Pipe | |
| Ductile Iron Pipe | | Cutting and Tapping | 3-26 |
| (B16.1, Class 250) | 8-13 | Design | 3-2 |
| Steel O.D. Pipe | | Field Gauging | 3-27 |
| (C115/A21.15) | 6-22 | General | Section 3 |
| Steel O.D. Pipe | | Hydrostatic Test | 3-7 |
| (B16.1, Class 250) | 12-33 | Loading Quantities | 3-29 |
| Concentric Reducers (See Reducers) | | Manufacture | 3-4 |
| Conductive Joints | | Marking | 3-7, 17-30 |
| Fastite | 2-15 | Physical Properties | 3-1 |
| Connecting Pieces | | Rounding | 3-27, 9-26 |
| Flanged and Plain End | 8-7 | Sewer Service | 3-23 |
| Flex-Lok | 10-11, 10-12 | Special Thickness Classes | 3-20 |
| Conversion Factors | | Stacking Heights | 3-29 |
| English | 17-32, 33 | Standard Laying Conditions | 3-12 |
| Metric | 17-34, 35 | Standard Pressure Classes | 3-13 |
| Corrosion Control | 11-9 | Tapping | 3-26 |



| | PAGE | | PAGE |
|------------------------------------|------------|---------------------------------------|---------------------|
| Testing | 3-6 | B16.1 Class 250 | 12-31 |
| Weights, Fastite, MJ, Plain End | 3-14, 3-21 | Designation of Outlets | 6-6 |
| | | Designation of Tap Locations | 6-5 |
| | | Dimensions | 6-6, 6-7 |
| E | | Flanged Pipe | |
| Earth Loads | 6-7 | B16.1 Class 250 Flanges | 8-14 |
| Earthquake | | Flange and Flange, Fabricated | 8-6 |
| Eccentric Reducers (See Reducers) | | Flange and Fastite, Fabricated | 8-9 |
| Energy Savings | | Flange and MJ, Fabricated | 8-8 |
| with Ductile Iron Pipe | 17-2 | Flange and Plain End, Fabricated | 8-7 |
| Engineering Data | Section 17 | General | Section 8 |
| Equivalent Pipe Diameters | 17-10 | Joint Materials | 8-2, 8-3, 8-4, 8-12 |
| | | Flanged Pipe | |
| | | Statically Cast (Spools) | |
| | | Maximum Length | 8-11 |
| | | Minimum Length | 8-10 |
| | | Minimum Tap Distance | 17-21 |
| | | Flare (Bell Mouth) Castings | 7-9 |
| | | Flex-Lok Ball Joint Pipe | 10-2 |
| | | Flex-Lok Closure Assemblies | 10-12 |
| | | Flex-Lok Connecting Pieces | 10-12 |
| | | Flex-Ring Joint (See Joints) | |
| | | Allowable Deflection | 9-12 |
| | | Fittings | Section 4 |
| | | Pipe | 9-12 |
| | | Flow of Water in Pipe | |
| | | Energy Savings | 17-2 |
| | | Equivalent Pipe Diameters | 17-10 |
| | | Hazen-Williams Formula | 17-2 |
| | | Head Loss Tables | 17-5 — 17-8 |
| | | Manning Formula | 17-9 |
| | | Formulas | |
| | | Hazen-Williams Flow | 17-2 |
| | | Head Loss | 17-2 |
| | | Hoop Stress | 1-2 |
| | | Manning | 17-9 |
| | | Mathematical | 17-27 |
| | | Present Value of Money | 17-3 |
| | | Pipe Lengths, Offset Connections | 17-25 |
| | | Pumping Cost | 17-2 |
| | | Radius of Curve | 2-9, 2-20 |
| | | Rotated Fittings and Inclined Runs | 17-26 |
| | | Friction Loss of Pipe | 17-4 |
| | | | |



| | PAGE | | PAGE |
|--------------------------------------|---------------|-------------------------------|--------------|
| G | | Bell & Spigot Joint | |
| Gaskets | | Accessories | 12-3 |
| Fast-Grip | 9-2 | Bell & Spigot Pipe | 12-3 |
| Fastite | 2-6 | Bends — Flanged, Special | |
| Fastite — Rubber Types | 2-7 | B16.1 Class 250 | 12-30 |
| Fastite Conductive | 2-15 | Double Branch 90° | 12-25 |
| Flanged, B16.1 Class 25 | 12-29 | Return (180°) | 12-25 |
| Flanged, B16.1 Class 250 | 12-30 | Blow-Off Branches | 12-3 |
| Flanged, Standard | 6-4 | Bosses, Welded-on | |
| Flanged, Toruseal | 6-21, 8-3 | Pipe | 12-47, 12-48 |
| Mechanical Joint | 2-19 | Fastite Joint Gray Iron Pipe, | |
| Mechanical Joint — | | 14" -48" | 12-9 |
| Rubber Types | 2-17 | Field Adaptable Spigot | |
| Glands | | Rings (FR) | 12-43 |
| Flex-Lok | 10-2 | Flanged Fittings, | |
| Mechanical Joint | 5-24 | AWWA C100 | 12-26, 12-27 |
| Mechanical Joint Retainer | 12-39 | B16.1 Class 25 | 12-29 |
| Gray Iron Pipe (Obsolete) | | B16.1 Class 250 | 12-31 |
| 2" and 2¼" | 12-18 | Flanged Gray Iron Pipe | 12-11 |
| Bell and Spigot | 12-3 | Flex-Ring Pipe, 14" -36", | |
| Flanged | 12-11 | (Hinged Locking | |
| General | Section 12 | Ring Style) | 12-44 |
| Manufacture | 12-1 | General | Section 12 |
| Monoloy | 12-17 | Gray Iron Pipe | Section 12 |
| Pit Cast | 12-2 | Lok-Fast | 12-13 |
| Standard Laying Conditions | 12-2 | Lok-Set Joint Pipe | 12-12 |
| Standard Thickness | | Lugged Fastite | 12-38 |
| Classes | 12-2, 12-5 | Mechanical Joint/Flanged and | |
| Weights | 12-6, 12-7 | Long PE 90° Bends | 12-28 |
| Working Pressures | 12-6, 12-7 | Mechanical Joint Ductile Iron | |
| Gravity Flow Service | 3-23 | Pipe, 14" -48" | 12-42 |
| Grooved Joint | 2-22 | Mechanical Joint Gray Iron | |
| | | Pipe, 14" -48" | 12-8 |
| H | | Mechanical Locked Joint | 12-10 |
| Hazen-Williams Flow Formula | 17-4 | Mechanical Joint Retainer | |
| Head Loss | | Glands | 12-39 |
| Formula | 17-2 | Molox Ball Joint Bends | 12-16 |
| General | 17-4 | Molox Ball Joint Pipe | 12-15 |
| Tables | 17-5 — 17-8 | Monoloy Pipe | 12-17 |
| Historical Data (Obsolete Materials) | | Offsets | 12-34 |
| 2" and 2¼" | 12-18 | Pit Cast Pipe | 12-2 |
| Abrasion Resistant Pipe | 12-12 | Short Body Bell & Spigot | |
| Bell & Spigot Fittings, | | Fittings | 12-24 |
| AWWA C 100 | 12-19 — 12-21 | Tapped and | |
| | | Plain End Adapters | 12-37 |
| | | Threaded Joint Pipe | 12-14 |



| | PAGE | | PAGE |
|-----------------------------------|--------------|--------------------------------|------------|
| Pipe Design | 1-2 | Lok-Ring, 54" -64" | 9-30 |
| Standards | 1-1 | Lok-Ring Fittings | 4-3 |
| Hydrostatic Test — | | Mechanical Joint | 2-18, 5-4 |
| Ductile Iron Pipe | 3-7 | Mechanical Joint Fittings | 5-4 |
| | | MJ Coupled Joint | 9-41 |
| I | | Shouldered End | 2-23 |
| Inclined Run Calculation | 17-26 | Joint Disassembly Instructions | |
| Installation Instructions | | Fast-Grip Gasket | 9-6 |
| (See Joint Assembly Instructions) | | Field Flex-Ring | 9-27 |
| | | Flex-Ring, 4" -12" | 9-16 |
| J | | Flex-Ring, 14" -54" | 9-19 |
| Joint Assembly Instructions | | Joint Materials (Accessories) | |
| Fast-Grip Gasket | 9-3 | Bell and Spigot | 12-3 |
| Fastite | 2-10 | Coupling Gland End | 9-49 |
| Field Flex-Ring | 9-22 | Fastite | 2-7 |
| Flex-Lok | 10-13, 10-14 | Fastite Conductive Gasket | 2-15 |
| Flex-Ring | 9-15 — 9-18 | Flanged, B16.1 Class 25 | 12/29 |
| Lok-Ring | 9-31 | Flanged, B16.1 Class 250 | 12-30 |
| Mechanical Joint | 2-21 | Flanged, Standard | 6-4, 8-4 |
| Mechanical Joint | | Flex-Lok | Section 10 |
| Retainer Gland | 12-41 | Mechanical Joint | 2-19 |
| MJ Coupled Joint | 9-40 | MJ Coupled Joint | 9-41 |
| Joint Deflection | | Toruseal Gasket | 6-21, 8-3 |
| Fast-Grip Gasket | 9-5 | Joint Separation | |
| Fastite | 2-9, 3-9 | Fastite | 2-9 |
| Fastite Special Deflection | | Mechanical Joint | 2-20 |
| Bell | 2-9, 3-9 | Joint Types | |
| Field Flex-Ring | 9-23 | Coupling Gland End | 9-41 |
| Flex-Lok | 10-7, 10-8 | Fast-Grip | 9-2 |
| Flex-Ring | 9-26 | Fastite | 2-1 |
| Lok-Ring | 9-30 | Fastite Conductive | 2-15 |
| Mechanical Joint | 2-20, 3-11 | Field Adaptable Spigot Ring | 12-43 |
| MJ Coupled Joint | 9-40 | Field Flex-Ring | 9-21 |
| Joint Dimensions | | Flanged C110/A21.10 & | |
| Bell and Spigot | 12-3 | C153/A21.53 | 6-4 |
| Coupling Gland End | 9-41 | Flanged C115/A21.15 | 8-4 |
| Fastite | 2-8, 3-8 | Flanged B16.1 Class 25 | 12-29 |
| Flanged, B16.1 Class 25 | 12-29 | Flanged B16.1 Class 250 | 12-30 |
| Flanged, B16.1 Class 250 | 12-30 | Flex-Lok | 10-2 |
| Flanged, Standard | 6-4, 8-4 | Flex-Ring | 9-12 |
| Flex-Lok | Section 10 | Flex-Ring | |
| Flex-Ring | 9-14 | (Hinged Locking | |
| Flex-Ring Fittings | 4-3 | Ring Style) | 12-44 |
| Grooved End | 2-22 | Grooved End | 2-22 |
| Lok-Ring, 14" -36" | 12-46 | Lok-Ring, 14" -36" | 12-46 |
| | | Lok-Ring, 54" -64" | 9-28 |



| | PAGE | | PAGE |
|------------------------------------|---------------|--------------------------------|--------------|
| Mechanical Joint | 5-23 | Sleeves, Solid | |
| Polyethylene Encasement | | MJ Transition | 5-25 |
| Dimensions and Weights | 11-13 | Wall, Mechanical Joint | 7-4 |
| General | 11-12 | Specials | Section 7 |
| Installation | 11-15 | Specifications (See Standards) | |
| Present Value of Money | 17-3 | Split Glands, MJ | 5-25 |
| Pressure Ratings | | Stacking Heights of Pipe | 3-29 |
| Min. Pressure Classes | | Standard Abbreviations | 17-14 |
| Ductile Iron Pipe | 3-16 | Standards | |
| Ductile Iron Pipe | 3-17 | AASHTO | 1-4 |
| Fittings | 4-2, 5-2, 6-2 | ASME | 1-6 |
| Push-On Joint (See Joint, Fastite) | | ANSI | 1-5, 1-6 |
| | | Applicable to American Pipe | |
| | | and Fittings | 1-4 |
| | | ASTM | 1-5 — 1-7 |
| | | AWWA | 1-5 — 1-7 |
| | | General | Section 1 |
| | | History of | 1-1 |
| | | Listing | |
| | | Ductile Iron Pipe & Fittings | 1-4 |
| | | Miscellaneous | 1-6 |
| | | Static Pipe Lengths | 8-10, 8-11 |
| | | Stud Bolts | |
| | | Flange Joints | 8-4, 8-12 |
| | | Mechanical Joints | 2-25 |
| | | Submarine, Subaqueous Pipe | Section 10 |
| | | Surge Allowance — | |
| | | Ductile Iron Pipe | 3-13 |
| | | | |
| | | T | |
| | | Tangential Outlets | 7-13 |
| | | Tapping Ductile Iron Pipe | 3-26 |
| | | Tapping/Outlet Saddles | 3-28, 7-10 |
| | | Taps In | |
| | | Ductile Pipe, Method | 3-26 |
| | | Ductile Pipe, No. | |
| | | Threads | 17-22, 17-23 |
| | | Fittings, Location Designation | 6-5 |
| | | Flanged Pipe | 17-21 |
| | | Taps, Outside Diameters | 17-21 |
| | | Tees | |
| | | Base, Flanged | 6-25 |
| | | Base, Mechanical Joint | 5-24 |
| | | Flanged, C110/A21.10 & | |
| | | C153/A21.53 | 6-12 |



Figure Index

| Fig. No. | | PAGE No. |
|-----------------|---|-----------------|
| 3-1 | Ductile Iron Pipe Minimum Physical Properties | 3-1 |
| 3-2 | Ductile Iron Pipe Standard Laying Conditions | 3-12 |
| 3-3 | Torch Cutting Ductile Iron Pipe | 3-27 |
| 3-4 | Bevel for Fastite Joint | 3-27 |
| 9-1 | Circular Welding Fixture | 9-45 |
| 12-1 | Gray Iron Pipe Standard Laying Conditions | 12-2 |
| 12-2 | Gray Iron Pipe - Laying Conditions "F" | 12-2 |
| 12-3 | Short Body Bell & Spigot Fittings | 12-24 |